

PowerScan™ PBT7100 Cordless Industrial Handheld Linear Imaging Bar Code Reader with Bluetooth® Wireless Technology



Product Reference Guide

Datalogic ADC, Inc.

959 Terry Street
Eugene, OR 97402
USA
Telephone: (541) 683-5700
Fax: (541) 345-7140

© 2008-2014 Datalogic ADC, Inc.

An Unpublished Work - All rights reserved. No part of the contents of this documentation or the procedures described therein may be reproduced or transmitted in any form or by any means without prior written permission of Datalogic ADC, Inc. or its subsidiaries or affiliates ("Datalogic" or "Datalogic ADC"). Owners of Datalogic products are hereby granted a non-exclusive, revocable license to reproduce and transmit this documentation for the purchaser's own internal business purposes. Purchaser shall not remove or alter any proprietary notices, including copyright notices, contained in this documentation and shall ensure that all notices appear on any reproductions of the documentation.

Should future revisions of this manual be published, you can acquire printed versions by contacting your Datalogic representative. Electronic versions may either be downloadable from the Datalogic website (www.datalogic.com) or provided on appropriate media. If you visit our website and would like to make comments or suggestions about this or other Datalogic publications, please let us know via the "Contact Datalogic" page.

Disclaimer

Datalogic has taken reasonable measures to provide information in this manual that is complete and accurate, however, Datalogic reserves the right to change any specification at any time without prior notice.

Datalogic and the Datalogic logo are registered trademarks of Datalogic S.p.A. in many countries, including the U.S.A. and the E.U. All other brand and product names may be trademarks of their respective owners.

PowerScan is a registered trademark of Datalogic ADC, Inc. in many countries, including the U.S.A. and the E.U.

Patents

See www.patents.datalogic.com for patent list.

Table of Contents

| | |
|---|-----------|
| Chapter 1. Introduction | 1 |
| About this Guide | 1 |
| Manual Overview | 1 |
| Manual Conventions | 2 |
| References | 2 |
| Technical Support | 3 |
| Datalogic Website Support | 3 |
| Reseller Technical Support | 3 |
| Telephone Technical Support | 3 |
| Chapter 2. Getting Started | 5 |
| About the Reader | 5 |
| Unpacking | 5 |
| Setting Up the Reader and Base Station | 6 |
| Install the Battery in the Reader | 6 |
| Connect the Base Station | 6 |
| Linking the Reader to a Base Station | 7 |
| Optional: Linking the Reader to a PC in Server Mode | 8 |
| Optional: Linking the Reader to a PC in Client Mode | 9 |
| Paging Feature | 9 |
| Programming | 9 |
| Using the Programming Barcodes | 9 |
| Select the Interface Type | 10 |
| Configure Interface Settings | 10 |
| Configure Other Features | 10 |
| Software Version Transmission | 10 |
| Resetting the Product Configuration to Defaults | 11 |
| Chapter 3. Interfaces | 13 |
| Interface Selection | 13 |
| Configuring the Interface | 13 |
| Global Interface Features | 17 |
| Host Commands — Obey/Ignore | 17 |
| USB Suspend Mode | 18 |
| Chapter 4. General Features | 19 |
| Double Read Timeout | 19 |
| Label Gone Timeout | 21 |
| Sleep Mode Timeout | 23 |
| LED and Beeper Indicators | 25 |
| Power On Alert | 25 |
| Good Read: When to Indicate | 26 |
| Good Read Beep Type | 27 |
| Good Read Beep Frequency | 28 |
| Good Read Beep Length | 28 |
| Good Read Beep Volume | 30 |
| Good Read LED Duration | 31 |
| Scanning Features | 33 |
| Scan Mode | 33 |
| Stand Mode Triggered Timeout | 35 |
| Scanning Active Time | 37 |

| | |
|---|-----------|
| Flash On Time | 39 |
| Flash Off Time | 41 |
| Stand Mode Sensitivity | 43 |
| Laser Pointer Control | 44 |
| Laser Pointer Period | 45 |
| Green Spot Duration | 46 |
| Chapter 5. RS-232 ONLY Interface..... | 47 |
| Introduction | 47 |
| RS-232 Standard Factory Settings | 47 |
| Baud Rate | 47 |
| Data Bits | 49 |
| Stop Bits | 50 |
| Parity | 51 |
| Handshaking Control | 52 |
| Chapter 6. RS-232/USB-Com Interfaces | 53 |
| Introduction | 53 |
| Standard Factory Settings | 53 |
| Intercharacter Delay | 54 |
| Beep On ASCII BEL | 56 |
| Beep On Not on File | 56 |
| ACK NAK Options | 57 |
| ACK Character | 58 |
| NAK Character | 60 |
| ACK NAK Timeout Value | 62 |
| ACK NAK Retry Count | 64 |
| ACK NAK Error Handling | 66 |
| Indicate Transmission Failure | 67 |
| Disable Character | 68 |
| Enable Character | 70 |
| Chapter 7. Keyboard Interface..... | 73 |
| Introduction | 73 |
| Standard Factory Settings | 73 |
| Scancode Tables | 73 |
| Country Mode | 74 |
| Caps Lock State | 77 |
| Numlock | 77 |
| Send Control Characters | 78 |
| Wedge Quiet Interval | 79 |
| Intercharacter Delay | 81 |
| Intercode Delay | 83 |
| USB Keyboard Speed | 85 |
| Chapter 8. USB-OEM Interface | 87 |
| Introduction | 87 |
| Standard Factory Settings | 87 |
| USB-OEM Device Usage | 88 |
| USB-OEM Interface Options | 89 |
| Chapter 9. IBM 46XX Interface..... | 91 |
| Introduction | 91 |
| IBM Standard Factory Settings | 91 |
| 46xx Number of Host Resets | 92 |
| Transmit Labels in Code 39 Format | 95 |
| IBM 46XX Interface Options | 96 |

| | |
|---|------------|
| Chapter 10. Wand Emulation Interface | 97 |
| Introduction | 97 |
| Wand Emulation Standard Factory Settings | 97 |
| Wand Idle State | 97 |
| Wand Polarity | 98 |
| Wand Signal Speed | 99 |
| Label Symbology Conversion | 100 |
| Transmit Noise | 101 |
| | |
| Chapter 11. Data Editing..... | 103 |
| Data Editing Overview | 103 |
| Please Keep In Mind... .. | 104 |
| Global Prefix/Suffix | 104 |
| Example: Setting a Prefix | 104 |
| Global AIM ID | 106 |
| GS1-128 AIM ID | 108 |
| Label ID | 109 |
| Label ID: Pre-loaded Sets | 109 |
| Label ID: Set Individually Per Symbology | 112 |
| Label ID Control | 114 |
| Label ID Symbology Selection | 115 |
| Case Conversion | 123 |
| Character Conversion | 124 |
| | |
| Chapter 12. Symbologies..... | 127 |
| Introduction | 127 |
| Symbologies | 127 |
| Standard Factory Settings for Symbologies | 128 |
| Disable All Symbologies | 128 |
| Coupon Control | 129 |
| UPC-A | 130 |
| UPC-A Enable/Disable | 130 |
| UPC-A Check Character Transmission | 130 |
| Expand UPC-A to EAN-13 | 131 |
| UPC-A Number System Character Transmission | 131 |
| In-Store Minimum Reads | 132 |
| UPC-E | 133 |
| UPC-E Enable/Disable | 133 |
| UPC-E Check Character Transmission | 133 |
| Expand UPC-E to EAN-13 | 134 |
| Expand UPC-E to UPC-A | 134 |
| UPC-E Number System Character Transmission | 135 |
| UPC-E Minimum Reads | 136 |
| GTIN Formatting | 137 |
| EAN 13 | 138 |
| EAN 13 Enable/Disable | 138 |
| EAN 13 Check Character Transmission | 138 |
| EAN-13 Flag 1 Character | 139 |
| EAN-13 ISBN Conversion | 140 |
| ISSN Enable/Disable | 140 |
| EAN 13 Minimum Reads | 141 |
| EAN 8 | 142 |
| EAN 8 Enable/Disable | 142 |
| EAN 8 Check Character Transmission | 142 |
| Expand EAN 8 to EAN 13 | 143 |
| EAN 8 Minimum Reads | 144 |
| UPC/EAN Global Settings | 145 |
| UPC/EAN Decoding Level | 145 |
| UPC/EAN Correlation | 147 |

| | |
|---|-----|
| UPC/EAN Reconstruction | 147 |
| UPC/EAN Price Weight Check | 148 |
| UPC-A Minimum Reads | 149 |
| Add-Ons | 150 |
| Optional Add-ons | 150 |
| Optional Add-On Timer | 152 |
| Optional GS1-128 Add-On Timer | 155 |
| P2 Add-Ons Minimum Reads | 158 |
| P5 Add-Ons Minimum Reads | 159 |
| GS1-128 Add-Ons Minimum Reads | 160 |
| GS1 DataBar™ Omnidirectional | 161 |
| GS1 DataBar Omnidirectional Enable/Disable | 161 |
| GS1 DataBar Omnidirectional GS1-128 Emulation | 161 |
| GS1 DataBar Omnidirectional Minimum Reads | 162 |
| GS1 DataBar™ Expanded | 163 |
| GS1 DataBar Expanded Enable/Disable | 163 |
| GS1 DataBar Expanded GS1-128 Emulation | 163 |
| GS1 DataBar Expanded Minimum Reads | 164 |
| GS1 DataBar Expanded Length Control | 165 |
| GS1 DataBar Expanded Set Length 1 | 166 |
| GS1 DataBar Expanded Set Length 2 | 168 |
| GS1 DataBar™ Limited | 170 |
| GS1 DataBar Limited Enable/Disable | 170 |
| GS1 DataBar Limited GS1-128 Emulation | 170 |
| GS1 DataBar Limited Minimum Reads | 171 |
| Code 39 | 172 |
| Code 39 Enable/Disable | 172 |
| Code 39 Check Character Calculation | 173 |
| Code 39 Check Character Transmission | 174 |
| Code 39 Start/Stop Character Transmission | 174 |
| Code 39 Full ASCII | 175 |
| Code 39 Quiet Zones | 176 |
| Code 39 Minimum Reads | 177 |
| Code 39 Decoding Level | 178 |
| Code 39 Length Control | 180 |
| Code 39 Set Length 1 | 181 |
| Code 39 Set Length 2 | 183 |
| Code 39 Interdigit Ratio | 185 |
| Code 39 Character Correlation | 187 |
| Code 39 Stitching | 188 |
| Code 32 (Italian Pharmaceutical) | 189 |
| Code 32 Enable/Disable | 189 |
| Code 32 Feature Setting Exceptions | 189 |
| Code 32 Check Character Transmission | 190 |
| Code 32 Start/Stop Character Transmission | 190 |
| Code 39 CIP (French Pharmaceutical) | 191 |
| Code 39 CIP Enable/Disable | 191 |
| Code 128 | 191 |
| Code 128 Enable/Disable | 191 |
| Expand Code 128 to Code 39 | 192 |
| Code 128 Check Character Transmission | 192 |
| Code 128 Function Character Transmission | 193 |
| Code 128 Sub-Code Change Transmission | 194 |
| Code 128 Quiet Zones | 195 |
| Code 128 Minimum Reads | 196 |
| Code 128 Decoding Level | 197 |
| Code 128 Length Control | 199 |
| Code 128 Set Length 1 | 200 |
| Code 128 Set Length 2 | 202 |
| Code 128 Character Correlation | 204 |

| | |
|--|-----|
| Code 128 Stitching | 205 |
| GS1-128 | 206 |
| GS1-128 Enable | 206 |
| Interleaved 2 of 5 (I 2 of 5) | 207 |
| I 2 of 5 Enable/Disable | 207 |
| I 2 of 5 Check Character Calculation | 208 |
| I 2 of 5 Check Character Transmission | 209 |
| I 2 of 5 Minimum Reads | 210 |
| I 2 of 5 Decoding Level | 211 |
| I 2 of 5 Length Control | 213 |
| I 2 of 5 Set Length 1 | 214 |
| I 2 of 5 Set Length 2 | 216 |
| I 2 of 5 Character Correlation | 218 |
| I 2 of 5 Stitching | 219 |
| Interleaved 2 of 5 CIP HR | 220 |
| Interleaved 2 of 5 CIP HR Enable/Disable | 220 |
| Datalogic 2 of 5 | 220 |
| Datalogic 2 of 5 Enable/Disable | 220 |
| Datalogic 2 of 5 Check Character Calculation | 221 |
| Datalogic 2 of 5 Minimum Reads | 222 |
| Datalogic 2 of 5 Decoding Level | 222 |
| Datalogic 2 of 5 Length Control | 223 |
| Datalogic 2 of 5 Set Length 1 | 224 |
| Datalogic 2 of 5 Set Length 2 | 226 |
| Datalogic 2 of 5 Interdigit Maximum Ratio | 228 |
| Datalogic 2 of 5 Character Correlation | 230 |
| Datalogic 2 of 5 Stitching | 231 |
| Codabar | 232 |
| Codabar Enable/Disable | 232 |
| Codabar Check Character Calculation | 233 |
| Codabar Check Character Transmission | 234 |
| Codabar Start/Stop Character Transmission | 234 |
| Codabar Start/Stop Character Set | 235 |
| Codabar Start/Stop Character Match | 236 |
| Codabar Quiet Zones | 237 |
| Codabar Minimum Reads | 238 |
| Codabar Decoding Level | 239 |
| Codabar Length Control | 241 |
| Codabar Set Length 1 | 242 |
| Codabar Set Length 2 | 244 |
| Codabar Interdigit Ratio | 246 |
| Codabar Character Correlation | 248 |
| Codabar Stitching | 249 |
| ABC Codabar | 250 |
| ABC Codabar Enable/Disable | 250 |
| ABC Codabar Concatenation Mode | 250 |
| ABC Codabar Dynamic Concatenation Timeout | 251 |
| ABC Codabar Force Concatenation | 252 |
| Code 11 | 253 |
| Code 11 Enable/Disable | 253 |
| Code 11 Check Character Calculation | 254 |
| Code 11 Check Character Transmission | 255 |
| Code 11 Minimum Reads | 256 |
| Code 11 Length Control | 257 |
| Code 11 Set Length 1 | 258 |
| Code 11 Set Length 2 | 260 |
| Code 11 Interdigit Ratio | 262 |
| Code 11 Decoding Level | 264 |
| Code 11 Character Correlation | 266 |
| Code 11 Stitching | 267 |

| | |
|--|-----|
| Standard 2 of 5 | 268 |
| Standard 2 of 5 Enable/Disable | 268 |
| Standard 2 of 5 Check Character Calculation | 269 |
| Standard 2 of 5 Check Character Transmission | 269 |
| Standard 2 of 5 Minimum Reads | 270 |
| Standard 2 of 5 Decoding Level | 270 |
| Standard 2 of 5 Length Control | 271 |
| Standard 2 of 5 Set Length 1 | 272 |
| Standard 2 of 5 Set Length 2 | 274 |
| Standard 2 of 5 Character Correlation | 276 |
| Standard 2 of 5 Stitching | 277 |
| Industrial 2 of 5 | 278 |
| Industrial 2 of 5 Enable/Disable | 278 |
| Industrial 2 of 5 Check Character Calculation | 278 |
| Industrial 2 of 5 Check Character Transmission | 279 |
| Industrial 2 of 5 Length Control | 280 |
| Industrial 2 of 5 Set Length 1 | 281 |
| Industrial 2 of 5 Set Length 2 | 283 |
| Industrial 2 of 5 Minimum Reads | 285 |
| Industrial 2 of 5 Stitching | 286 |
| Industrial 2 of 5 Character Correlation | 286 |
| IATA | 287 |
| IATA Enable/Disable | 287 |
| IATA Check Character Transmission | 287 |
| ISBT 128 | 288 |
| ISBT 128 Concatenation | 288 |
| ISBT 128 Concatenation Mode | 289 |
| ISBT 128 Dynamic Concatenation Timeout | 290 |
| ISBT 128 Force Concatenation | 291 |
| ISBT 128 Advanced Concatenation Options | 291 |
| MSI | 292 |
| MSI Enable/Disable | 292 |
| MSI Check Character Calculation | 293 |
| MSI Check Character Transmission | 294 |
| MSI Length Control | 294 |
| MSI Set Length 1 | 295 |
| MSI Set Length 2 | 297 |
| MSI Minimum Reads | 299 |
| MSI Decoding Level | 300 |
| Plessey | 302 |
| Plessey Enable/Disable | 302 |
| Plessey Check Character Calculation | 303 |
| Plessey Check Character Transmission | 304 |
| Plessey Length Control | 304 |
| Plessey Set Length 1 | 305 |
| Plessey Set Length 2 | 307 |
| Plessey Minimum Reads | 309 |
| Plessey Decoding Level | 310 |
| Plessey Stitching | 311 |
| Plessey Character Correlation | 312 |
| Code 93 | 312 |
| Code 93 Enable/Disable | 312 |
| Code 93 Check Character Calculation | 313 |
| Code 93 Check Character Transmission | 314 |
| Code 93 Length Control | 314 |
| Code 93 Set Length 1 | 315 |
| Code 93 Set Length 2 | 317 |
| Code 93 Minimum Reads | 319 |
| Code 93 Decoding Level | 320 |
| Code 93 Quiet Zones | 322 |

| | |
|---|------------|
| Code 93 Stitching | 323 |
| Code 93 Character Correlation | 323 |
| Codablock F | 324 |
| Codablock F Enable/Disable | 324 |
| Codablock F EAN Enable/Disable | 325 |
| Codablock F AIM Check | 325 |
| Codablock F Length Control | 326 |
| Codablock F Set Length 1 | 327 |
| Codablock F Set Length 2 | 329 |
| Code 4 | 331 |
| Code 4 Enable/Disable | 331 |
| Code 4 Check Character Transmission | 332 |
| Code 4 Hex to Decimal Conversion | 332 |
| Code 5 | 333 |
| Code 5 Enable/Disable | 333 |
| Code 5 Check Character Transmission | 334 |
| Code 5 Hex to Decimal Conversion | 334 |
| Code 4 and Code 5 Common Configuration Items | 335 |
| Code 4 and 5 Decoding Level | 335 |
| Code 4 and Code 5 Minimum Reads | 337 |
| Follett 2 of 5 | 338 |
| Follett 2 of 5 Enable/Disable | 338 |
| Chapter 13. BT Features..... | 339 |
| Introduction | 339 |
| Standard Factory Settings | 339 |
| BT Beeper Features | 340 |
| ACK Beep | 340 |
| Beep Frequency | 341 |
| Beep Duration | 342 |
| Beep Volume | 344 |
| BT Base Station Beep | 345 |
| Disconnect Beep | 345 |
| BT Leash Alarm | 346 |
| Flash Update | 348 |
| BT Automatic Flash Update | 348 |
| Request Flash Update | 348 |
| Configuration Update | 349 |
| Automatic Configuration Update | 349 |
| Configuration Update From Base Station to Handheld | 349 |
| Copy Configuration From Handheld to Base Station | 350 |
| Battery Charge Mode | 351 |
| Powerdown Timeout | 352 |
| BT Poll Rate | 354 |
| Batch Features | 356 |
| Batch Mode | 356 |
| Send Batch | 357 |
| Erase Batch Memory | 357 |
| BT Batch Mode Transmit Delay | 358 |
| BT Security Features | 359 |
| BT Pin Code | 359 |
| BT Security Mode | 362 |
| Linking the Reader | 363 |
| Optional: Linking a PowerScan 7000 Reader to a PBT7100 Base Station | 363 |
| BT Address Stamping | 364 |
| Source Radio Address Transmission | 364 |
| Source Radio Address Delimiter Character | 365 |
| Appendix A. Technical Specifications | 367 |

| | |
|---|------------|
| Standard Cable Pinouts | 370 |
| Appendix B. Standard Defaults | 371 |
| Appendix C. LED and Beeper Indications | 385 |
| General Functions — LED and Beeper Indications | 386 |
| BT Beeper Indications | 387 |
| BT LED Indications | 388 |
| Error Codes | 389 |
| Appendix D. Sample Barcodes | 391 |
| UPC-A | 391 |
| Interleaved 2 of 5 | 391 |
| Codabar | 392 |
| Code 11 | 392 |
| DataBar (RSS) | 393 |
| DataBar-14 | 393 |
| Appendix E. Keypad | 395 |
| Appendix F. Scancode Tables | 399 |
| Control Character Emulation | 399 |
| Single Press and Release Keys | 399 |
| Interface Type PC AT PS/2 or USB-Keyboard | 400 |
| Interface type PC AT PS/2 Alt Mode or USB-Keyboard Alt Mode | 402 |
| Digital Interface | 404 |
| IBM31xx 102-key | 406 |
| IBM XT | 408 |
| Microsoft Windows Codepage 1252 | 410 |
| Index | 411 |

Chapter 1

Introduction

About this Guide

This Product Reference Guide (PRG) is provided for users seeking advanced technical information, including connection, programming, maintenance and specifications. The Quick Reference Guide (QRG) and other publications associated with this product are downloadable free of charge from the website listed on the back cover of this manual.

Typically, units are factory-programmed for the most common terminal and communications settings. If you need to modify any programmable settings, custom configuration can be accomplished by scanning the programming barcodes within this guide.

Programming can alternatively be performed using the Datalogic Aladdin™ Configuration application which is downloadable from the Datalogic website listed on the back cover of this manual. This multi-platform utility program allows device configuration using a PC. It communicates to the device using a serial or USB cable and can also create configuration barcodes to print.

Manual Overview

[Chapter 1, Introduction](#) provides a product overview, unpacking instructions, and cable connection information.

[Chapter 2, Getting Started](#) presents information about unpacking and setting up the reader.

[Chapter 3, Interfaces](#) consists of interface configuration barcodes and details.

[Chapter 4, General Features](#) includes programming barcodes for selecting common features for the reader and general use barcodes to customize how the data is transmitted to the host device.

[Chapter 5, RS-232 ONLY Interface](#) supplies information about setting up the reader for RS-232 operation.

[Chapter 6, RS-232/USB-Com Interfaces](#) features information about options involving both the RS-232 and USB-Com interfaces.

[Chapter 7, Keyboard Interface](#) discusses how to set up the reader for Keyboard Wedge operation.

[Chapter 8, USB-OEM Interface](#) explains how to set the reader up for USB operation.

[Chapter 9, IBM 46XX Interface](#) is a resource for setting up an IBM interface.

[Chapter 11, Data Editing](#) offers advanced configuration options for customization of scanned data output.

[Chapter 12, Symbologies](#) defines options for all symbologies and provides the programming barcodes necessary for configuring these features.

[Appendix A, Technical Specifications](#) lists physical and performance characteristics, as well as environmental and regulatory specifications. It also provides standard cable pin-outs.

[Appendix B, Standard Defaults](#) references common factory default settings for reader features and options.

[Appendix C, LED and Beeper Indications](#) supplies tables containing descriptions of the functions and behaviors of the reader's LED and Beeper indicators.

[Appendix D, Sample Barcodes](#) offers sample barcodes of several common symbologies.

[Appendix E, Keypad](#) includes numeric barcodes to be scanned for certain parameter settings.

[Appendix F, Scancode Tables](#) lists control character emulation information for Wedge and USB Keyboard interfaces.

Manual Conventions

The following conventions are used in this document:

The symbols listed below are used in this manual to notify the reader of key issues or procedures that must be observed when using the reader:



NOTE

Notes contain information necessary for properly diagnosing, repairing and operating the reader.



CAUTION

The CAUTION symbol advises you of actions that could damage equipment or property.

References

Current versions of the Product Reference Guide (PRG), Quick Reference Guide (QRG), the Datalogic Aladdin™ Configuration application, and any other manuals, instruction sheets and utilities for this product can be downloaded from the website listed on the back cover of this manual. Alternatively, printed copies or product support CDs can be purchased through your Datalogic reseller.

Technical Support

Datalogic Website Support

The Datalogic website (www.scanning.datalogic.com) is the complete source for technical support and information for Datalogic products. The site offers product support, product registration, warranty information, product manuals, product tech notes, software updates, demos, and instructions for returning products for repair.

Reseller Technical Support

An excellent source for technical assistance and information is an authorized Datalogic reseller. A reseller is acquainted with specific types of businesses, application software, and computer systems and can provide individualized assistance.

Telephone Technical Support

If you do not have internet or email access, you may contact Datalogic technical support at (541) 349-8283 or check the back cover of your manual for more contact information.

NOTES

Chapter 2

Getting Started

About the Reader

Advancements in the LED technology used in this reader significantly improve the illumination of the target field of view, resulting in higher scan efficiency. Whether used in Single Trigger or Continuous Mode, the ergonomic design of the reader will help to promote comfortable handling during extended periods of use.

The reader/Base Station can communicate using the following interfaces:

RS-232 — The reader can communicate with a standard or Wincor-Nixdorf (W-N) RS-232 host.

RS-232 OPOS — This interface is used for OPOS/UPOS/JavaPOS systems.

Keyboard Wedge (KBW) — When connected using this interface, the host interprets scanned data as keystrokes and supports several international keyboards (for the Windows® environment). See [Country Mode on page 74](#) for a full listing.

USB — Select to communicate either by USB OEM, USB COM, USB Keyboard interface or USB POS types by scanning the appropriate interface type barcodes available in this manual. The default interface is USB-KBD for Wedge models (7230) and USB-OEM for IBM models (7210).

IBM — IBM Port 5B or Port 9B are selectable interface options.

Wand Emulation — This interface produces an electrical signal that represents the bars and spaces of a label.

Unpacking

Check carefully to ensure the reader, Base Station and any accessories ordered are present and undamaged. If any damage occurred during shipment, contact [Technical Support on page 3](#).

KEEP THE PACKAGING. Should the unit ever require service, it should be returned in its original shipping container.

Setting Up the Reader and Base Station

Follow the steps provided in this section to connect and get your reader up and communicating with its host:

1. [Install the Battery in the Reader](#)
2. [Connect the Base Station](#)
3. [Select the Interface Type](#)
4. [Configure Interface Settings](#) (only if not using factory settings for that interface)
5. [Configure Other Features](#) (if modifications are needed from factory settings)

Install the Battery in the Reader

Follow the instructions in the Quick Reference Guide (QRG) to install the battery pack and verify reader operation.

Connect the Base Station

[Figure 1](#) shows how to connect the Base Station to a terminal, PC or other host device. Turn off the host before connection and consult the manual for that equipment (if necessary) before proceeding. Connect the interface cable before applying power to the Base Station.

Base Station Connection and Routing — Fully insert the Power Cable and Interface (I/F) Cable connectors into their respective ports in the underside of the Base Station (see [Figure 1](#)), then plug the Base Station AC Adapter into the AC outlet. Alternatively, you can either loop the cables around the routing clips and back through the routing channel to the front of the Base Station as shown, or the cables can be fed directly out the back of the Base Station via the routing clips.

Figure 1. Connecting the Base Station

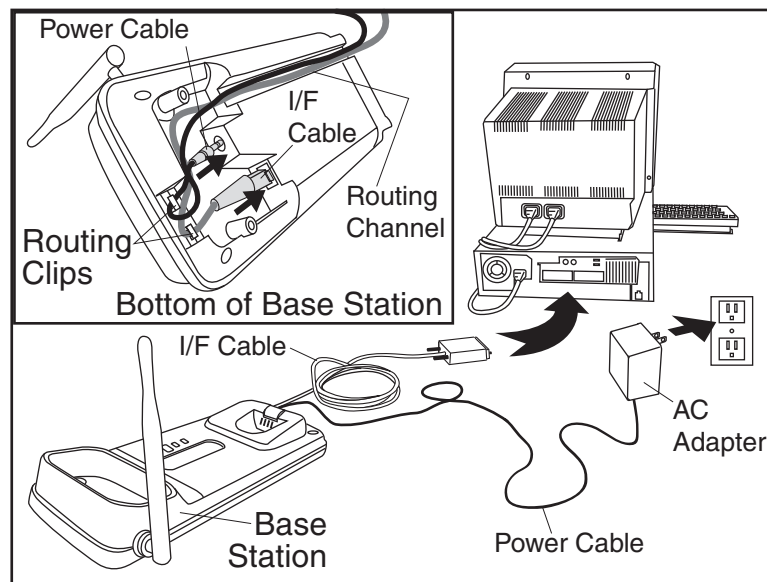

Host Connection — The interface type was specified at the time your reader was ordered, however you should verify before connection that the reader's cable type is compatible with your host equipment. Most connections plug directly into the host device as shown in [Figure 2](#). Keyboard Wedge interface cables have a 'Y' connection where its female end mates with the male end of the cable from the keyboard and the remaining end at the keyboard port on the terminal/PC.

Figure 2. Connecting to the Host

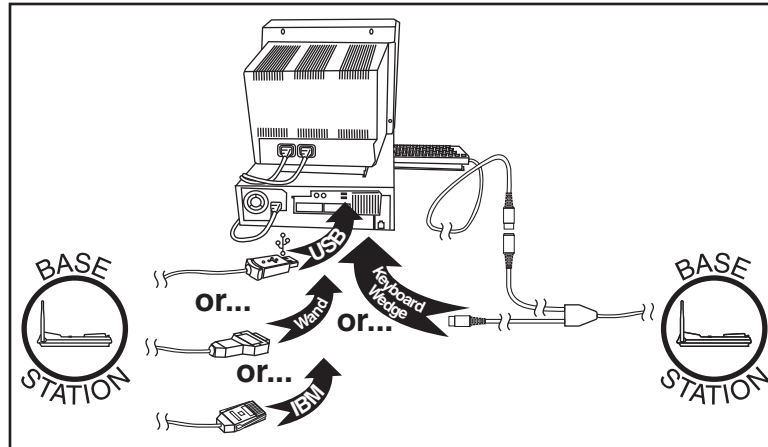

Power Connection — Plug the AC Adapter in to an approved AC wall socket with the cable facing downwards (as shown in [Figure 1](#)) to prevent undue strain on the socket.

Linking the Reader to a Base Station

To link a reader to a Base Station, press the Link Button (see [Figure 3](#)) on the Base Station for at least one second to place the base in "Link Mode," then scan the barcode below or the Link barcode located on the Base Station using the reader to be linked. The Link barcode on the Base Station contains an identifier that is unique to that Base Station. This enables the reader to quickly find and link to that Base Station.

A successful link is indicated by three ascending tones from the reader. A high-low-high-low tone indicates the link attempt was unsuccessful. A single green LED flash during this tone indicates no Base Station was discovered. Two green LED flashes during this tone indicates that more than one Base Station was discovered and the reader did not link. Three LED flashes during this tone indicate a security error.

Figure 3. Labeling and Nomenclature

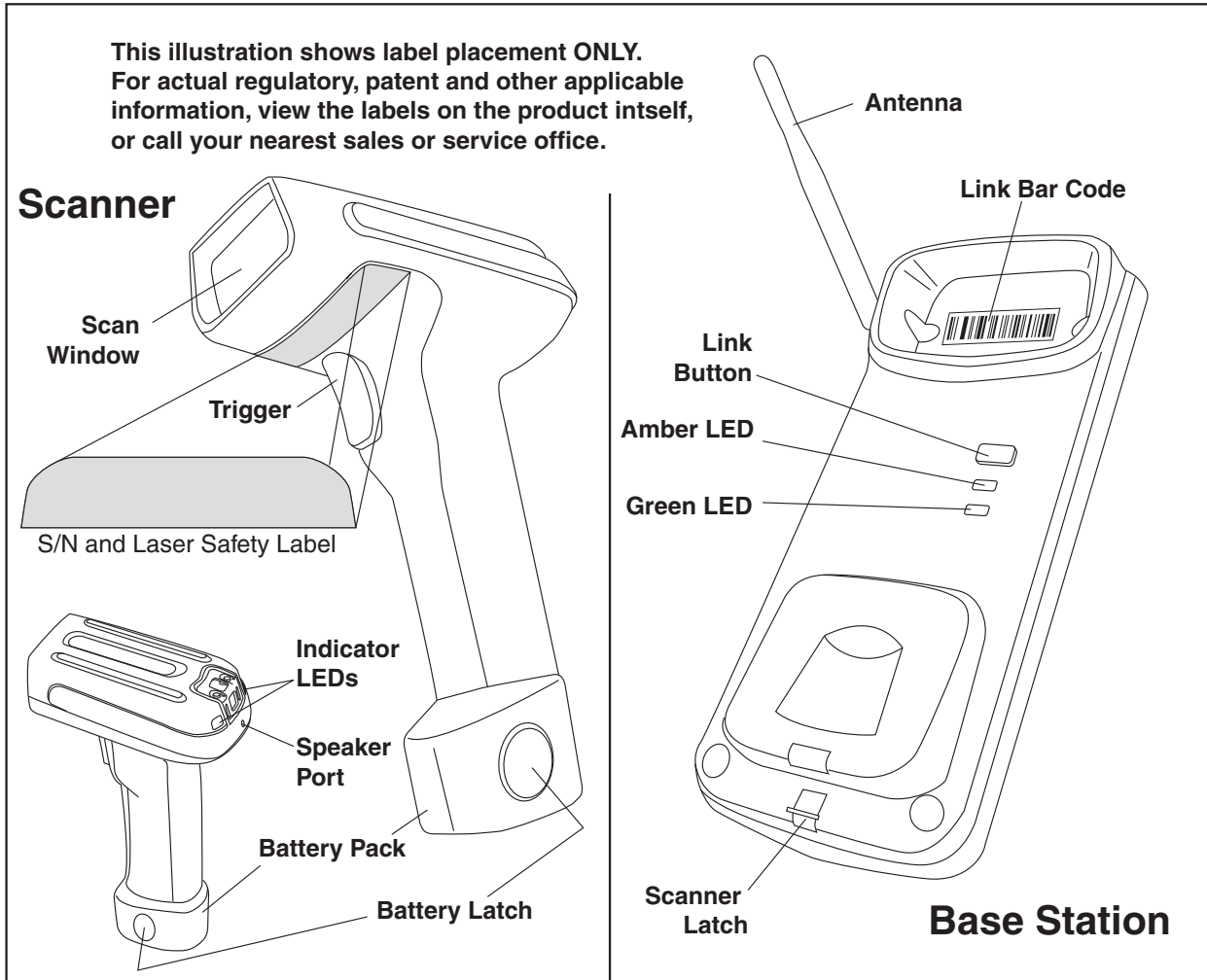

Optional: Linking the Reader to a PC in Server Mode

A reader can optionally be linked in server mode to a Bluetooth-enabled PC with the serial port profile.

To do this, follow these steps:

1. Ensure the PC or terminal can network with Bluetooth devices and that it is powered on.
2. Scan the “Link to a PC” barcode below.

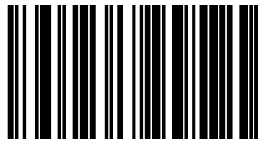

Link to a PC in Server Mode

3. On the PC, scan for network devices.
4. Select the “Datalogic PBT7100 Reader.” Make sure “Secure Connection” is disabled.
5. Select “connect” on the PC to link the reader to the PC.

Optional: Linking the Reader to a PC in Client Mode

A reader can optionally be linked in client mode to a Bluetooth-enabled PC with the serial port profile.

To do this, follow these steps:

1. Ensure the PC or terminal can network with Bluetooth devices and that it is powered on.
2. Ensure that a COM port is assigned under Services within the bluetooth setup menu.
3. Create a Link label that contains the address of the PC bluetooth adapter.



The bluetooth address can be found under "Properties" within in the bluetooth setup menu.

NOTE

The link label is a Code 128 function 3 label with the following format:
<FN3 char>LnkB<12 character bluetooth address>

4. Scan the link label created in step 3.

Paging Feature

To help locate a missing reader, press the Base Station Link Button momentarily (less than one second). This will cause the reader to beep five times at its loudest volume setting.

Programming

The reader is typically factory-configured with a set of default features. After scanning the interface barcode from the [Interfaces](#) section, you can select other options and customize your reader through use of the instructions and programming barcodes available in the corresponding features section for your interface and also the [Data Editing](#) and [Symbologies](#) chapters of this manual.

Using the Programming Barcodes

This manual contains feature descriptions and barcodes which allow you to reconfigure your reader and Base Station. Some programming barcode labels, like the [Resetting the Product Configuration to Defaults on page 11](#), require only the scan of that single label to enact the change. Most of the programming labels in this manual, however, require the reader to be placed in Programming Mode prior to scanning them. Scan an ENTER/EXIT barcode once to enter Programming Mode. Once the reader is in Programming Mode, you can scan a number of parameter settings before scanning the ENTER/EXIT barcode a second time, which will then accept your changes, exit Programming Mode and return the reader to normal operation.



There are some exceptions to the typical programming sequence described above. Please read the description and setting instructions carefully when configuring each given programmable feature.

NOTE

Select the Interface Type

Upon completing the physical connection between the Base Station and the host, proceed directly to [Interfaces on page 13](#) for information and programming for the interface type the Base Station is connected to (for example: RS-232, Keyboard Wedge, USB, etc.) and scan the appropriate barcode in that section to select your system's correct interface type.

Configure Interface Settings

Each interface type is associated to a specific set of default features. If after scanning the interface barcode from the [Interfaces](#) section, your installation requires you to select options to further customize your reader, turn to the appropriate section for your interface type as listed below:

- [RS-232 ONLY Interface, starting on page 47](#)
- [RS-232/USB-Com Interfaces, starting on page 53](#)
- [Keyboard Interface, starting on page 73](#)
- [USB-OEM Interface, starting on page 87](#)
- [IBM 46XX Interface, starting on page 91](#)
- [Wand Emulation Interface, starting on page 97](#)

Configure Other Features

If your installation requires different programming than the standard factory default settings, the following sections of this manual allow configuration of non-interface-specific settings you might require:

[General Features](#) — General Features includes programming for scanning, beeper and LED indicators and other such universal settings.

[Symbologies](#) — Includes options concerning the barcode label types (symbologies). These settings allow you to enable/disable symbologies, set label lengths, require check digit, etc.

Software Version Transmission

The software version of the device can be transmitted over the RS-232 and Keyboard interfaces by scanning the following label.



Transmit Software Version

Resetting the Product Configuration to Defaults

If you aren't sure what programming options are in your imager, or you've changed some options and want to restore the Custom Default Configuration that may have been saved in the imager, scan the [Restore Custom Default Configuration](#) barcode below. This will restore the custom configuration for the currently active interface.



NOTE

Custom defaults are based on the interface type. Configure the imager for the correct interface before scanning this label.

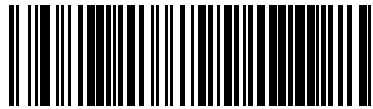

Restore Custom Default Configuration

If you aren't sure what programming options are in your imager, or you've changed some options and want to restore the Factory Configuration, you have two options. You can scan the [Restore USA Factory Configuration](#) bar code or the [Restore EU Factory Configuration](#) bar code below. Both labels restore the imager configuration to the factory settings including the interface type. The USA label restores Label IDs to those historically used in the USA. The EU label restores Label IDs to those historically used in Europe. The Label ID sets for USA and EU are shown in the Label ID section of this manual.



Restore USA Factory Configuration

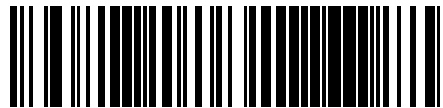

Restore EU Factory Configuration

The programming section lists the factory default settings for each of the menu commands (indicated by shaded blocks and bold text) on the following pages.

NOTES

Chapter 3

Interfaces

Interface Selection

Each reader model will support one of the following sets of host interfaces:

General Purpose Models (5 volt supply)

RS-232
RS-232 OPOS
USB
Keyboard Wedge
Wand Emulation

Retail Point of Sale Models (4 to 14 volt supply)

RS-232
RS-232 OPOS
USB
IBM 46XX

Configuring the Interface

Scan the programming barcode from this section which selects the appropriate interface type matching the system the reader will be connected to. Next, proceed to the corresponding chapter in this manual (also listed in [Table 1](#)) to configure any desired settings and features associated with that interface.



NOTE

Unlike some other programming features and options, interface selections require that you scan only one programming barcode label. **DO NOT** scan an ENTER/EXIT barcode prior to scanning an interface selection barcode.



Some interfaces require the scanner to start in the disabled state when powered up. If additional scanner configuration is desired while in this state, pull the trigger and hold it for five seconds. The scanner will change to a state that allows programming with barcodes.

Table 1. Available Interfaces

| RS-232 | | FEATURES |
|---|--|--|
| RS-232 standard interface |  Select RS232-STD | Set RS-232 Interface Features starting on page 47 |
|  Select RS232-WN | RS-232 Wincor-Nixdorf | |
| RS-232 for use with OPOS/UPOS/JavaPOS |  Select RS-232 OPOS | |
|  Select USB-COM-STD ^a | USB Com to simulate RS-232 standard interface | |
| IBM | | FEATURES |
|  Select IBM-P5B | IBM-46xx Port 5B reader interface | Set IBM Interface Features starting on page 91 |
| IBM-46xx Port 9B reader interface |  Select IBM-P9B | |
| USB-OEM | | FEATURES |
|  Select USB-OEM | USB-OEM (can be used for OPOS/UPOS/JavaPOS) | Set USB-OEM Interface Features starting on page 87 |

^a. Download the correct USB Com driver from www.datalogic.com

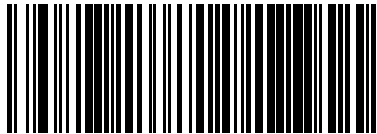
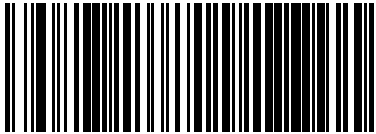
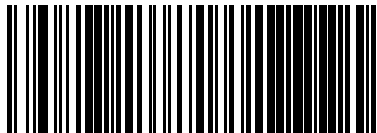
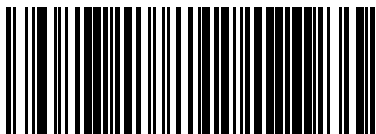
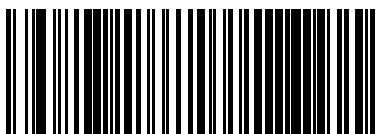
| KEYBOARD | FEATURES |
|---|--|
| <p>AT, PS/2 25-286, 30-286, 50, 50Z, 60, 70, 80, 90 & 95 w/Standard Key Encoding</p>  <p>Select KBD-AT</p> | <p>Set KEYBOARD WEDGE Interface Features starting on page 73</p> |
|  <p>Select KBD-AT-NK</p> <p>Keyboard Wedge for IBM AT PS2 with standard key encoding but without external keyboard</p> | |
| <p>AT, PS/2 25-286, 30-286, 50, 50Z, 60, 70, 80, 90 & 95 w/Alternate Key</p>  <p>Select KBD-AT-ALT</p> | |
|  <p>Select KBD-AT-ALT-NK</p> <p>Keyboard Wedge for IBM AT PS2 with alternate key encoding but without external keyboard</p> | |
| <p>PC/XT w/Standard Key Encoding</p>  <p>Select KBD-XT</p> | |
|  <p>Select KBD-IBM-3153</p> <p>Keyboard Wedge for IBM Terminal 3153</p> | |

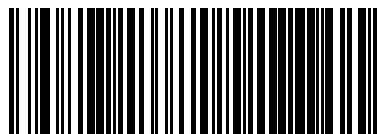
| KEYBOARD — cont. | | FEATURES |
|--|--|--|
| <p>Keyboard Wedge for IBM Terminals 31xx, 32xx, 34xx, 37xx make only keyboard</p> |  Select KBD-IBM-M | <p>Set KEYBOARD WEDGE Interface Features starting on page 73</p> |
|  Select KBD-IBM-MB | <p>Keyboard Wedge for IBM Terminals 31xx, 32xx, 34xx, 37xx make break keyboard</p> | |
| <p>Keyboard Wedge for DIGITAL Terminals VT2xx, VT3xx, VT4xx</p> |  Select KBD-DIG-VT | |
|  Select USB Keyboard | <p>USB Keyboard with standard key encoding</p> | |
| <p>USB Keyboard with alternate key encoding</p> |  Select USB Alternate Keyboard | |
|  Select USB-KBD-APPLE | <p>USB Keyboard for Apple computers</p> | |
| WAND EMULATION | | FEATURES |
| <p>Wand Emulation</p> |  Select WAND | <p>Set WAND Interface Features starting on page 97</p> |

Global Interface Features

The following interface features are configurable by all interface types. To set features specific to your interface, turn to that section of this manual:

- [RS-232 ONLY Interface on page 47](#)
- [Keyboard Interface on page 73](#)
- [USB-OEM Interface on page 87](#)
- [IBM 46XX Interface on page 91](#)

Host Commands — Obey/Ignore

This option specifies whether the reader will obey or ignore host commands. When set to ignore, the reader will ignore all host commands except for those necessary for:

- service mode
- flash programming mode
- keeping the interface active
- transmission of labels.



USB Suspend Mode

This setting enables/disables the ability of USB interfaces to enter suspend mode.



Chapter 4

General Features

Double Read Timeout

To prevent a double read of the same label, the Double Read Timeout sets the minimum time allowed between reads of labels of the same symbology and data. If the unit reads a label and sees the same label again within the Double Read Timeout, the second read of the label will be ignored. Double Read Timeout does not apply to scan modes that require a trigger pull for each label that is read.

| | |
|---|--|
|  ENTER/EXIT PROGRAMMING MODE | |
| |  Double Read Timeout = 0.1 Second |
|  Double Read Timeout = 0.2 Second | |
| |  Double Read Timeout = 0.3 Second |
|  Double Read Timeout = 0.4 Second |  |

Double Read Timeout – continued

| | |
|---|--|
|  ENTER/EXIT PROGRAMMING MODE | |
| |  Double Read Timeout = 0.5 Second |
|  Double Read Timeout = 0.6 Second | |
| |  Double Read Timeout = 0.7 Second |
|  Double Read Timeout = 0.8 Second | |
| |  Double Read Timeout = 0.9 Second |
|  Double Read Timeout = 1 Second | |

Label Gone Timeout

This feature sets the time after the last label segment is seen before the reader prepares for a new label. The timeout can be set within a range of 10 milliseconds to 2,550 milliseconds (2.55 seconds) in 10ms increments.

Follow these instructions to set this feature:

1. Determine the desired setting in milliseconds.
2. Divide the desired setting by 10 (setting is in 10ms increments). Pad the result with leading zeroes to yield three digits. For example: 0 = 000, 5 = 005, 20 = 020, etc.
3. Scan the ENTER/EXIT PROGRAMMING MODE barcode to enter Programming Mode.
4. Scan the barcode: SELECT LABEL GONE TIMEOUT SETTING.
5. Scan the appropriate three alpha-numeric characters from the keypad in [Appendix E, Keypad](#) representing the duration which was determined in the steps above. You will hear a two-beep indication after the last character.



If you make a mistake before the last character, scan the CANCEL barcode to abort and not save the entry string. You can then start again at the beginning.

NOTE

6. Scan the ENTER/EXIT PROGRAMMING MODE barcode to exit Programming Mode.

This completes the procedure. See [Table 2](#) for some examples of how to set this feature.

Table 2. Timeout Setting Examples

| STEP | ACTION | EXAMPLES | | | |
|------|---|------------------|------------------|-------------------|--------------------|
| 1 | Desired Setting | 50ms | 150ms | 1800ms (1.8 sec.) | 2550ms (2.55 sec.) |
| 2 | Divide by 10 (and pad with leading zeroes) | 005 | 015 | 180 | 255 |
| 3 | Scan ENTER/EXIT PROGRAMMING MODE | | | | |
| 4 | Scan SELECT LABEL GONE TIMEOUT SETTING | | | | |
| 5 | Scan Three Characters From Appendix E, Keypad | '0', '0' and '5' | '0', '1' and '5' | '1', '8' and '0' | "2", '5' and '5' |
| 6 | Scan ENTER/EXIT PROGRAMMING MODE | | | | |

Label Gone Timeout – cont.

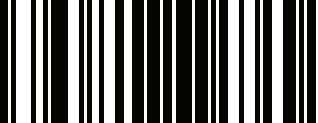
| |
|--|
|  ENTER/EXIT PROGRAMMING MODE |
|--|

| |
|--|
|  Select Label Gone Timeout Setting |
|--|

Make a mistake? Scan the CANCEL barcode to abort and not save the entry string. You can then start again at the beginning.

| |
|---|
|  CANCEL |
|---|

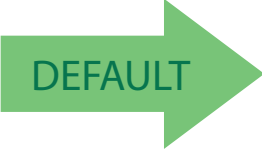
 016 = Timeout of 160 ms

Sleep Mode Timeout

Specifies the timeout value for the reader to enter low power Sleep Mode.

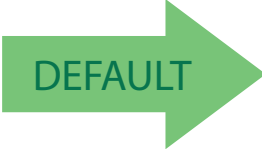
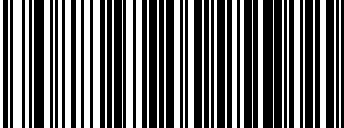
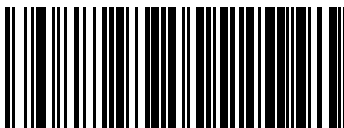
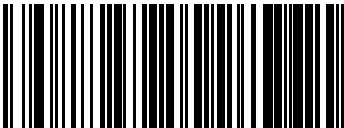
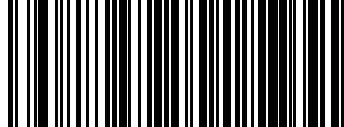
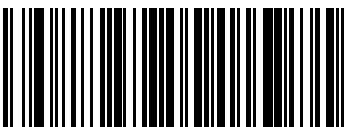
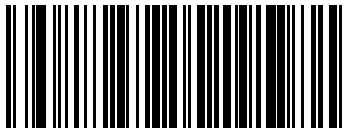
| | |
|---|--|
|  ENTER/EXIT PROGRAMMING MODE | |
|  |  Sleep Mode Timeout = Disable |
|  Sleep Mode Timeout = 500ms | |
| |  Sleep Mode Timeout = 1 Second |
|  Sleep Mode Timeout = 2 Seconds | |
| |  Sleep Mode Timeout = 3 Seconds |
|  Sleep Mode Timeout = 4 Seconds | |

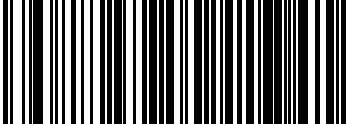

Sleep Mode Timeout – continued

| | |
|--|--|
|  ENTER/EXIT PROGRAMMING MODE | |
| |  Sleep Mode Timeout = 5 Seconds |
|  Sleep Mode Timeout = 6 Seconds | |
| |  Sleep Mode Timeout = 7 Seconds |
|  Sleep Mode Timeout = 8 Seconds | |
| |  Sleep Mode Timeout = 9 Seconds |
|  Sleep Mode Timeout = 9.9 Seconds (9,900ms max.) | |

LED and Beeper Indicators

Power On Alert

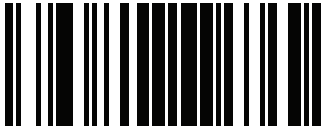
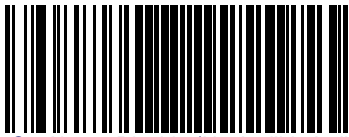
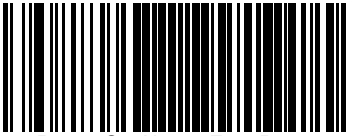
Disables or enables the indication (from the Beeper) that the reader is receiving power.

| | |
|--|--|
|  ENTER/EXIT PROGRAMMING MODE | |
| |  Power On Alert = Disable (No Audible Indication) |
|  Power On Alert = Four Beeps |  DEFAULT |

Good Read: When to Indicate

This feature specifies when the reader will provide indication (beep and/or flash its green LED) upon successfully reading a barcode. Choices are:

- Good Read = Indicate after decode
- Good Read = Indicate after transmit
- Good Read = Indicate after CTS goes inactive, then active



This option, which uses CTS, is only valid for RS-232 interfaces.

NOTE



Good Read Beep Type

Specifies whether the good read beep has a mono or bitonal beep sound.





Good Read Beep Frequency

Adjusts the good read beep to sound at a selectable low, medium or high frequency, selectable from the list below. (Controls the beeper's pitch/tone.)

| | |
|--|--|
|  ENTER/EXIT PROGRAMMING MODE | |
| |  Good Read Beep Frequency = Low |
|  Good Read Beep Frequency = Medium | |
|  DEFAULT |  Good Read Beep Frequency = High |

Good Read Beep Length

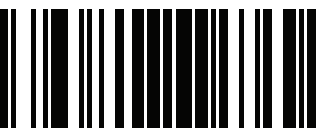
Specifies the duration of a good read beep.



| | |
|--|---|
|  ENTER/EXIT PROGRAMMING MODE | |
| |  Good Read Beep Length = 60 msec |

Good Read Beep Length — continued

| | |
|---|--|
|  ENTER/EXIT PROGRAMMING MODE | |
|  Good Read Beep Length = 80 msec |  |
| |  Good Read Beep Length = 100 msec |
|  Good Read Beep Length = 120 msec | |
| |  Good Read Beep Length = 140 msec |
|  Good Read Beep Length = 160 msec | |
| |  Good Read Beep Length = 180 msec |
|  Good Read Beep Length = 200 msec | |

Good Read Beep Volume

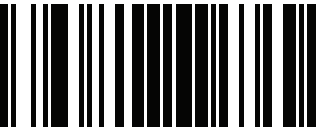
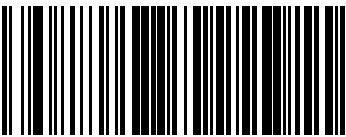
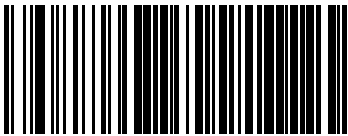
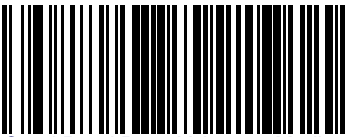
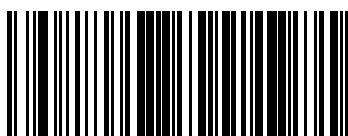
Selects the beeper volume (loudness) upon a good read beep. There are three selectable volume levels.

| | |
|---|--|
|  ENTER/EXIT PROGRAMMING MODE | |
| |  Good Read Beep Volume = Beeper Off |
|  Good Read Beep Volume = Low | |
| |  Good Read Beep Volume = Medium |
|  Good Read Beep Volume = High |  DEFAULT |

Good Read LED Duration

This feature specifies the amount of time that the Good Read LED remains on following a good read. The good read LED on time can be set within a range of 100 milliseconds to 25,500 milliseconds (0.1 to 25.5 seconds) in 100ms increments.

Follow these instructions to set this feature:

1. Determine the desired setting in milliseconds. A setting of 0 means that the good read LED stays on until the next time the trigger is pulled.
2. Divide the desired setting by 100 (setting is in 100 ms increments). Pad the result with leading zeroes to yield three digits. For example: 0 = 000, 5 = 005, 20 = 020, etc.
3. Scan the ENTER/EXIT PROGRAMMING MODE barcode to enter Programming Mode.
4. Scan the barcode: SELECT GOOD READ LED DURATION SETTING.
5. Scan the appropriate three digits from the keypad in [Appendix E, Keypad](#) representing the duration which was determined in the steps above. You will hear a two-beep indication after the last character.



If you make a mistake before the last character, scan the CANCEL barcode to abort and not save the entry string. You can then start again at the beginning.

NOTE

6. Scan the ENTER/EXIT PROGRAMMING MODE barcode to exit Programming Mode.

This completes the procedure. See [Table 3](#) for some examples of how to set this feature.

Table 3. Good Read LED Duration Setting Examples

| STEP | ACTION | EXAMPLES | | | |
|------|---|--|------------------|------------------|----------------------|
| 1 | Desired Setting | Good Read LED stays on until next trigger pull (000) | 200ms | 1500ms | 25,500ms (25.5 sec.) |
| 2 | Divide by 10 (and pad with leading zeroes) | 000 | 002 | 015 | 255 |
| 3 | Scan ENTER/EXIT PROGRAMMING MODE | | | | |
| 4 | Scan SELECT LABEL GONE TIMEOUT SETTING | | | | |
| 5 | Scan Three Characters From Appendix E, Keypad | '0', '0' and '0' | '0', '0' and '2' | '0', '1' and '5' | '2', '5' and '5' |
| 6 | Scan ENTER/EXIT PROGRAMMING MODE | | | | |

Good Read LED Duration – cont.

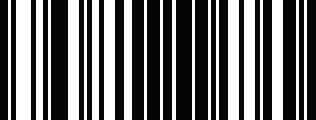
| |
|--|
|  ENTER/EXIT PROGRAMMING MODE |
|--|

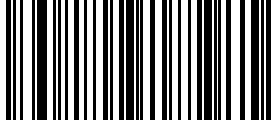
| | |
|--|--|
|  Select Good Read LED Duration Setting | |
|--|--|

| | |
|--|---|
| Make a mistake? Scan the CANCEL barcode to abort and not save the entry string. You can then start again at the beginning. |  CANCEL |
|--|---|

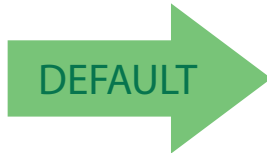

020 = Good Read LED stays on for 2 seconds.



Indicators are dimmed during sleep.

NOTE

Scanning Features

Scan Mode

Selects the scan operating mode for the reader. Selections are:

Trigger Single — When the trigger is pulled, scanning is activated until one of the following occurs:

- [Scanning Active Time](#) has elapsed
- a label has been read
- the trigger is released

This mode is associated with typical handheld reader operation: when the trigger is pulled, scanning starts and the product scans until the trigger is released, or a label is read, or the maximum [Scanning Active Time](#) has elapsed.

Trigger Hold Multiple — When the trigger is pulled, scanning starts and the product scans until the trigger is released or [Scanning Active Time](#) has elapsed. Reading a label does not disable scanning. [Double Read Timeout](#) prevents undesired multiple reads of the same label while in this mode.

Trigger Pulse Multiple — When the trigger is pulled, continuous scanning is activated until [Scanning Active Time](#) has elapsed or the trigger has been released and pulled again. [Double Read Timeout](#)¹ prevents undesired multiple reads of the same label while in this mode.

Flashing — The reader flashes¹ on and off regardless of the trigger status. Flash rate is controlled by [Flash On Time](#) and [Flash Off Time](#).

Always On — No trigger pull is required to read a barcode. Scanning is continually on. If the trigger is pulled, the reader acts as if it is in [Trigger Single Mode](#). [Double Read Timeout](#)¹ prevents undesired multiple reads of the same label while in this mode.

Stand Mode — No trigger pull is required to read a barcode. Scanning is turned on automatically when an item is placed in reader's field of view. If the trigger is pulled, the reader acts as if it is in single read mode. [Double Read Timeout](#)¹ prevents undesired multiple reads of the same label while in this mode.

Trigger Object Sense — This mode is similar to Stand Mode, except that a trigger pull is required to activate the decoder.

1. Controlled by [Flash On Time](#).

Scan Mode – continued

| | |
|---|---|
|  ENTER/EXIT PROGRAMMING MODE | |
|  Scan Mode = Trigger Single |  |
| |  Scan Mode = Trigger Hold Multiple |
|  Scan Mode = Trigger Pulse Multiple | |
| |  Scan Mode = Flashing |
|  Scan Mode = Always On | |
| |  Scan Mode = Stand Mode |
|  Scan Mode = Trigger Object Sense | |

Stand Mode Triggered Timeout

This feature specifies the time to remain in **Trigger Single** mode after the trigger is pulled while in **Stand Mode**.



This timeout is only used when the Scan Mode is configured as **Stand Mode**.

NOTE

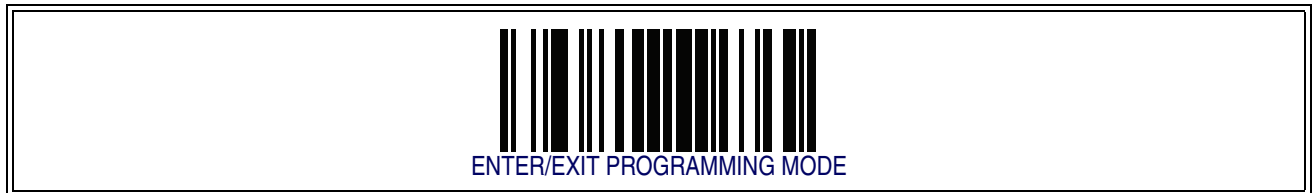

| | |
|---|---|
|  <p>Stand Mode Triggered Timeout = 0.5 Seconds</p> |  |
| |  <p>Stand Mode Triggered Timeout = 1.5 Seconds</p> |
|  <p>Stand Mode Triggered Timeout = 2 Seconds</p> | |
| |  <p>Stand Mode Triggered Timeout = 3 Seconds</p> |
|  <p>Stand Mode Triggered Timeout = 4 Seconds</p> | |

Stand Mode Triggered Timeout – continued

| | |
|---|---|
|  ENTER/EXIT PROGRAMMING MODE | |
| |  Stand Mode Triggered Timeout = 6 Seconds |
|  Stand Mode Triggered Timeout = 8 Seconds | |
| |  Stand Mode Triggered Timeout = Switch back to Trigger Single on trigger pull |

Scanning Active Time

This setting specifies the amount of time that the reader stays in scan ON state once the state is entered. The range for this setting is from 1 to 255 seconds in 1-second increments.

Follow these instructions to set this feature:

1. Determine the desired setting.
2. Pad the result with leading zeroes to yield three digits. For example: 0 = 000, 5 = 005, 20 = 020, etc.
3. Scan the ENTER/EXIT PROGRAMMING MODE barcode to enter Programming Mode.
4. Scan the barcode: SELECT SCANNING ACTIVE TIME SETTING.
5. Scan the appropriate three digits from the keypad in [Appendix E, Keypad](#), that represent the duration which was determined in the steps above. You will hear a two-beep indication after the last character.



If you make a mistake before the last character, scan the CANCEL barcode to abort and not save the entry string. You can then start again at the beginning.

NOTE

6. Scan the ENTER/EXIT PROGRAMMING MODE barcode to exit Programming Mode.

This completes the procedure. See [Table 4](#) for some examples of how to set this feature.

Table 4. Scanning Active Time Setting Examples

| STEP | ACTION | EXAMPLES | | | |
|------|---|------------------|--------------------|-------------------|-------------------------|
| 1 | Desired Setting | 1 Second | 90 Sec. (1.5 min.) | 180 Sec. (3 min.) | 255 Seconds (4.25 min.) |
| 2 | Pad leading zero(es) | 001 | 090 | 180 | 255 |
| 3 | Scan ENTER/EXIT PROGRAMMING MODE | | | | |
| 4 | Scan SELECT SCANNING ACTIVE TIME SETTING | | | | |
| 5 | Scan Three Characters From Appendix E, Keypad | '0', '0' and '1' | '0', '9' and '0' | '1', '8' and '0' | '2', '5' and '5' |
| 6 | Scan ENTER/EXIT PROGRAMMING MODE | | | | |

Scanning Active Time – cont.

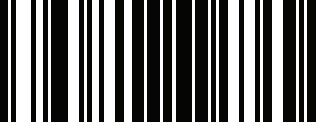
| |
|--|
|  ENTER/EXIT PROGRAMMING MODE |
|--|

| |
|--|
|  Select Scanning Active Time Setting |
|--|

| |
|--|
| |
|--|

Make a mistake? Scan the CANCEL barcode to abort and not save the entry string. You can then start again at the beginning.

| |
|---|
|  CANCEL |
|---|

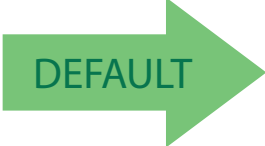
 005 = Scanning is active for 5 Seconds

Flash On Time

This feature specifies the ON time for the indicator LED while in Flash Mode. The selectable range is 100 to 9,900 milliseconds (0.1 to 9.9 seconds), in 100 millisecond increments.

Follow these instructions to set this feature.

1. Determine the desired setting in milliseconds.
2. Divide the desired setting by 100 (setting is in 100ms increments). Pad the result with leading zeroes to yield two digits. For example: 0 = 00, 5 = 05, 20 = 20, etc.
3. Scan the ENTER/EXIT PROGRAMMING MODE barcode to enter Programming Mode.
4. Scan the barcode: SELECT FLASH ON TIME SETTING.
5. Scan the appropriate two digits from the keypad in [Appendix E, Keypad](#) representing the duration which was determined in the steps above. You will hear a two-beep indication after the last character.



If you make a mistake before the last character, scan the CANCEL barcode to abort and not save the entry string. You can then start again at the beginning.

NOTE

6. Scan the ENTER/EXIT PROGRAMMING MODE barcode to exit Programming Mode.

This completes the procedure. See [Table 5](#) for some examples of how to set this feature.

Table 5. Flash On Time Setting Examples

| STEP | ACTION | EXAMPLES | | | |
|------|---|-------------|------------------|-------------------|--------------------|
| 1 | Desired Setting | 500ms | 1,000ms (1 sec.) | 5200ms (5.2 sec.) | 9,900ms (9.9 sec.) |
| 2 | Divide by 100 (and pad with leading zeroes to yield two digits) | 05 | 10 | 52 | 99 |
| 3 | Scan ENTER/EXIT PROGRAMMING MODE | | | | |
| 4 | Scan SELECT FLASH OFF TIME SETTING | | | | |
| 5 | Scan Two Characters From Appendix E, Keypad | '0' and '5' | '1' and '0' | '5' and '2' | '9' and '9' |
| 6 | Scan ENTER/EXIT PROGRAMMING MODE | | | | |

Flash On Time – cont.

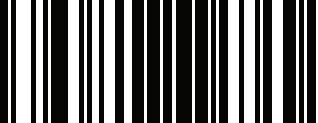
| |
|--|
|  ENTER/EXIT PROGRAMMING MODE |
|--|

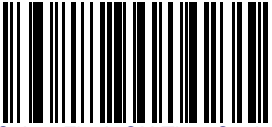
| |
|---|
|  Select Flash ON Time Setting |
|---|

Make a mistake? Scan the CANCEL barcode to abort and not save the entry string. You can then start again at the beginning.

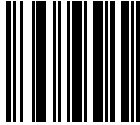
| |
|---|
|  CANCEL |
|---|

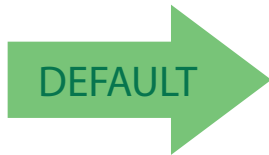

10 = Flash is ON for 1 Second

Flash Off Time

This feature specifies the OFF time for the indicator LED while in Flash Mode. The selectable range is 100 to 9,900 milliseconds (0.1 to 9.9 seconds), in 100 millisecond increments.

Follow these instructions to set this feature.

1. Determine the desired setting in milliseconds.
2. Divide the desired setting by 100 (setting is in 100ms increments). Pad the result with leading zeroes to yield two digits. For example: 0 = 00, 5 = 05, 20 = 20, etc.
3. Scan the ENTER/EXIT PROGRAMMING MODE barcode to enter Programming Mode.
4. Scan the barcode: SELECT FLASH OFF TIME SETTING.
5. Scan the appropriate two digits from the keypad in [Appendix E, Keypad](#), that represent the duration which was determined in the steps above. You will hear a two-beep indication after the last character.



If you make a mistake before the last character, scan the CANCEL barcode to abort and not save the entry string. You can then start again at the beginning.

NOTE

6. Scan the ENTER/EXIT PROGRAMMING MODE barcode to exit Programming Mode.

This completes the procedure. See [Table 6](#) for some examples of how to set this feature.

Table 6. Flash Off Time Setting Examples

| STEP | ACTION | EXAMPLES | | | |
|------|---|-------------|------------------|-------------------|--------------------|
| 1 | Desired Setting | 500ms | 1,000ms (1 sec.) | 5200ms (5.2 sec.) | 9,900ms (9.9 sec.) |
| 2 | Divide by 100 (and pad with leading zeroes to yield two digits) | 05 | 10 | 52 | 99 |
| 3 | Scan ENTER/EXIT PROGRAMMING MODE | | | | |
| 4 | Scan SELECT FLASH OFF TIME SETTING | | | | |
| 5 | Scan Two Characters From Appendix E, Keypad | '0' and '5' | '1' and '0' | '5' and '2' | '9' and '9' |
| 6 | Scan ENTER/EXIT PROGRAMMING MODE | | | | |

Flash Off Time – cont.

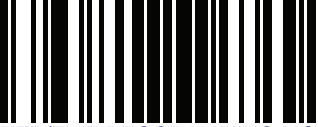
| |
|--|
|  ENTER/EXIT PROGRAMMING MODE |
|--|

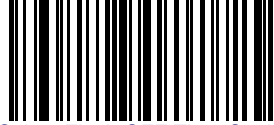
| |
|--|
|  Select Flash OFF Time Setting |
|--|

Make a mistake? Scan the CANCEL barcode to abort and not save the entry string. You can then start again at the beginning.

| |
|---|
|  CANCEL |
|---|

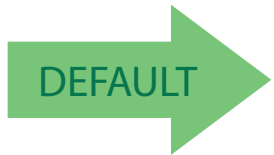

06 = Flash is OFF for 600ms

Stand Mode Sensitivity

Sets the sensitivity level for stand mode wakeup. Choices are low, medium and high.

| | |
|--|--|
|  ENTER/EXIT PROGRAMMING MODE | |
| |  Stand Mode Sensitivity = Low |
|  Stand Mode Sensitivity = Medium |  DEFAULT |
| |  Stand Mode Sensitivity = High |







Laser Pointer Control

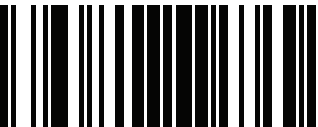

The Laser Pointer is a value-added option which might not have been included when your reader was ordered.

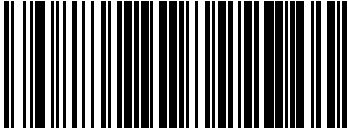
NOTE

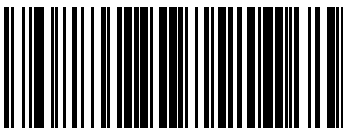
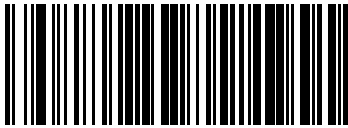
Specifies the amount of time that the laser pointer is turned on preliminary to scanning. When the trigger is pressed in Trigger Single Mode, the laser pointer will be activated for the time period configured by this feature. Immediately following this, the reader will start scanning.

| | |
|---|---|
|  ENTER/EXIT PROGRAMMING MODE | |
|  |  Laser Pointer Control = 0 msec (No preliminary pointer — i.e. start scanning immediately after trigger) |
|  Laser Pointer Control = 100 msec | |
| |  Laser Pointer Control = 200 msec |
|  Laser Pointer Control = 300 msec | |
| |  Laser Pointer Control = 400 msec |
|  Laser Pointer Control = 500 msec | |



Laser Pointer Period

This option specifies the period of the laser pointer blink during scanning. The laser pointer will be activated for the time specified by [Laser Pointer Control](#) then start blinking OFF then ON at a 50% duty cycle and a repeating period set by [Laser Pointer Period](#).

| | |
|---|---|
|  ENTER/EXIT PROGRAMMING MODE | |
| |  Laser Pointer Period = Laser Pointer Blinking Off |
|  Laser Pointer Period = 500 ms |  |
| |  Laser Pointer Period = 1 Second |
|  Laser Pointer Period = 1.5 Seconds | |
| |  Laser Pointer Period = 2 Seconds |

Green Spot Duration

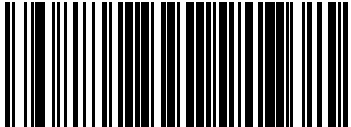
Specifies the duration of the good read pointer beam after a good read.

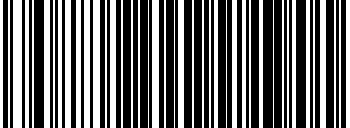
| | |
|--|---|
|  ENTER/EXIT PROGRAMMING MODE | |
| |  Green Spot Duration = Disable (Green Spot is Off) |
|  Green Spot Duration = Short (300 msec) |  |
| |  Green Spot Duration = Medium (500 msec) |
|  Green Spot Duration = Long (800 msec) | |

Chapter 5

RS-232 ONLY Interface

Introduction

Use the programming barcodes in this chapter if modifications to the standard RS-232 interface settings are necessary to meet your system's requirements. Additional settings which apply to both the RS-232 and USB interfaces are available in [Chapter 6, RS-232/USB-Com Interfaces](#).

RS-232 Standard Factory Settings

Reference [Appendix B, Standard Defaults](#) for a listing of standard factory settings.

Baud Rate

Baud rate is the number of bits of data transmitted per second. Set the reader's baud rate to match the baud rate setting of the host device. With an improper baud rate setting, data may not reach the host correctly.

| | |
|--|--|
|  ENTER/EXIT PROGRAMMING MODE | |
| |  Baud Rate = 1200 |
|  Baud Rate = 2400 | |
| |  Baud Rate = 4800 |

Baud Rate — continued

| | |
|--|--|
|  ENTER/EXIT PROGRAMMING MODE | |
|  Baud Rate = 9600 |  |
| |  Baud Rate = 19,200 |
|  Baud Rate = 38,400 | |
| |  Baud Rate = 57,600 |
|  Baud Rate = 115,200 | |

Data Bits

This parameter allows the reader to interface with devices requiring a 7-bit or 8-bit ASCII protocol for sending and receiving data.



Stop Bits

The stop bit(s) at the end of each transmitted character marks the end of transmission of one character and prepares the receiving device for the next character in the serial data stream. The number of stop bits selected (one or two) depends on the number the receiving terminal is programmed to accommodate. Set the number of stop bits to match host device requirements.

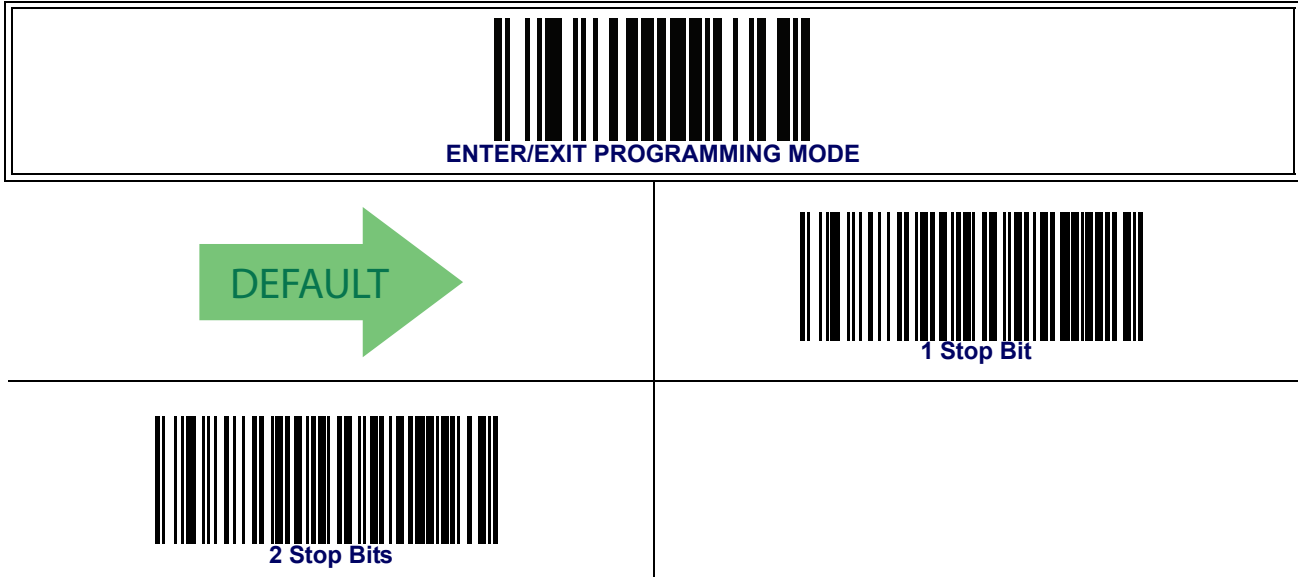

Parity

This feature specifies parity required for sending and receiving data. A parity check bit is the most significant bit of each ASCII coded character. Select the parity type according to host device requirements.

- Select None when no parity bit is required.
- Select Odd parity and the parity bit value is set to 0 or 1, based on data, to ensure that an odd number of 1 bits are contained in the coded character.
- Select Even parity and the parity bit value is set to 0 or 1, based on data, to ensure that an even number of 1 bits are contained in the coded character.



Handshaking Control

The data interface consists of an RS-232 port designed to operate either with or without the hardware handshaking lines, *Request to Send* (RTS), and *Clear to Send* (CTS). Handshaking Control includes the following options:

- RTS — RTS is asserted during transmissions. CTS is ignored.
- RTS/CTS — RTS is asserted during transmissions. CTS gates transmissions.
- RTS/XON/XOFF — RTS is asserted during transmissions. CTS is ignored. XON and XOFF gate transmissions.
- RTS On/CTS — RTS is always asserted. CTS gates transmissions.
- RTS/CTS Scan Control — RTS is asserted during transmissions. CTS gates transmissions and controls enable and disable state of scanner.

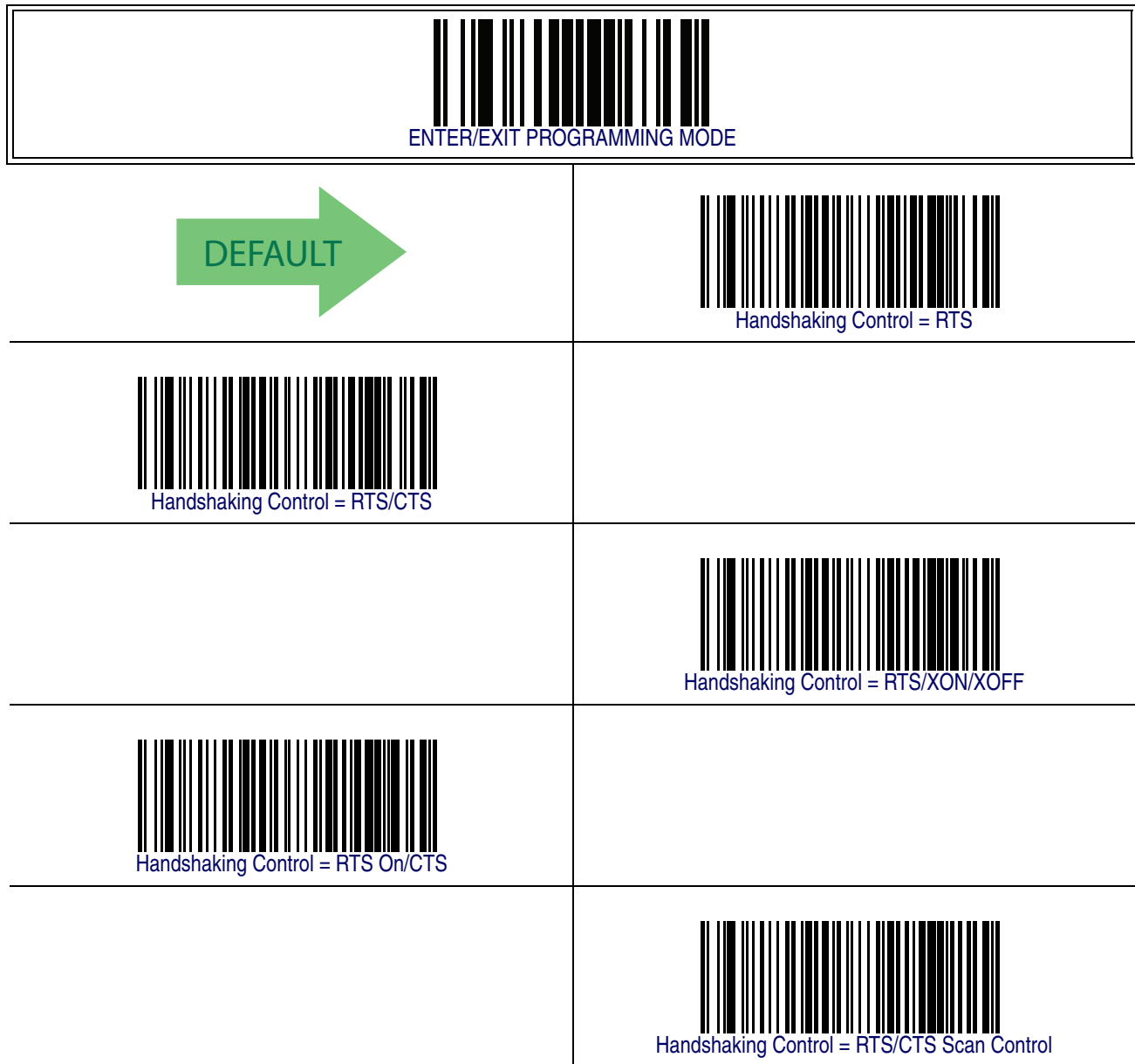

Chapter 6

RS-232/USB-Com Interfaces

Introduction

The programming barcodes in this chapter allow modifications to the standard RS-232 and USB-Com interfaces.

Standard Factory Settings

Reference [Appendix B, Standard Defaults](#) for a listing of standard factory settings.

Intercharacter Delay

This parameter specifies the intercharacter delay between the end of one character and the beginning of the next. The delay can be set within a range of zero (0) to 990 milliseconds in 10ms increments. A setting of zero specifies no delay.

To set the delay:

1. Determine the desired setting in milliseconds.
2. Divide the desired setting by 10 (setting is in 10ms increments). Pad the result with leading zeroes to yield two digits. For example: 0 = 00, 5 = 05, 20 = 20, etc.
3. Scan the ENTER/EXIT PROGRAMMING MODE barcode to enter Programming Mode.
4. Scan the barcode: SELECT INTERCHARACTER DELAY SETTING.
5. Scan the appropriate two digits from the keypad in [Appendix E, Keypad](#), that represent the duration which was determined in the steps above. You will hear a two-beep indication after the last character.



If you make a mistake before the last character, scan the CANCEL barcode to abort and not save the entry string. You can then start again at the beginning.

NOTE



6. Scan the ENTER/EXIT PROGRAMMING MODE barcode to exit Programming Mode.

This completes the procedure. See [Table 7](#) for some examples of how to set this feature.

Table 7. Intercharacter Delay Setting Examples

| STEP | ACTION | EXAMPLES | | | |
|------|--|-------------|-------------|------------|-------------|
| 1 | Desired Setting | 50ms | 150ms | 600ms | 850ms |
| 2 | Divide by 10 (and pad with leading zeroes to yield two-digits) | 05 | 15 | 60 | 85 |
| 3 | Scan ENTER/EXIT PROGRAMMING MODE | | | | |
| 4 | Scan SELECT INTERCHARACTER DELAY SETTING | | | | |
| 5 | Scan Two Characters From Appendix E, Keypad | '0' and '5' | '5' and '0' | 0' and '0' | '8' and '5' |
| 6 | Scan ENTER/EXIT PROGRAMMING MODE | | | | |

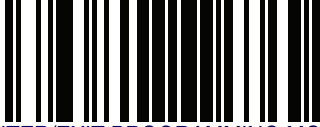
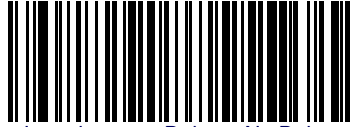
Intercharacter Delay – cont.

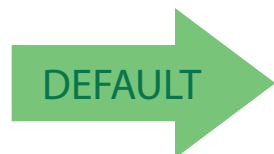

| | |
|---|---|
|  ENTER/EXIT PROGRAMMING MODE | |
| |  Intercharacter Delay = No Delay |
|  Select Intercharacter Delay Setting | |
| <p>Make a mistake? Scan the CANCEL barcode to abort and not save the entry string. You can then start again at the beginning.</p> |  CANCEL |



00 = No Intercharacter Delay

Beep On ASCII BEL

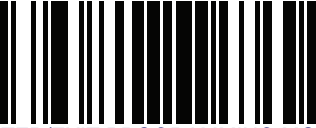
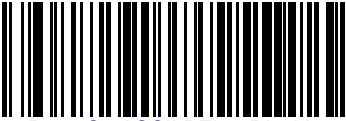
When this parameter is enabled, the reader issues a beep when a <BEL> character is detected on the RS-232 serial line. <BEL> is issued to gain a user's attention to an illegal entry or other important event.

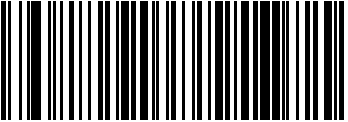
| | |
|--|--|
|  ENTER/EXIT PROGRAMMING MODE | |
|  Beep On ASCII BEL = Disable |  |
|  Beep On ASCII BEL = Enable | |

Beep On Not on File

This option enables/disables the action of the reader to sound a three beep sequence upon receiving a Not-On-File (NOF) host command.

| | |
|--|--|
|  ENTER/EXIT PROGRAMMING MODE | |
|  Beep On Not On File = Disable | |
|  |  Beep On Not On File = Enable |

ACK NAK Options

This enables/disables the ability of the reader to support the RS-232 ACK/NAK protocol. When configured, the reader and/or host sends an “ACK” when it receives data properly, and sends “NAK” when the data is in error.

Options are:

- Disable
- Enable for label transmission — The reader expects an ACK/NAK response from the host when a label is sent.
- Enable for host-command acknowledge — The reader will respond with ACK/NAK when the host sends a command.
- Enable for label transmission and host-command acknowledge

| | |
|---|---|
|  ENTER/EXIT PROGRAMMING MODE | |
|  DEFAULT |  ACK/NAK Protocol = Disable ACK/NAK |
|  ACK/NAK Protocol = Enable for label transmission | |
| |  ACK/NAK Protocol = Enable for host-command acknowledge |
|  ACK/NAK Protocol = Enable for label transmission and host-com- mand acknowledge | |

ACK Character

This setting specifies an ASCII character or hex value to be used as the ACK character. ASCII characters or any hex value from 0 to 0xFF can be selected.



NOTE

Setting to previously defined characters such as XON, XOFF, or host commands conflicts with normal operation of these characters. 8-bit data is not recognized when the option **Data Bits** has been set as 7 Data Bits.

To set this feature:

1. Determine the desired character or value.
2. Use the [ASCII Chart](#) on the inside back cover of this manual to find the hex equivalent for the desired character/value.
3. Scan the ENTER/EXIT PROGRAMMING MODE barcode to enter Programming Mode.
4. Scan the barcode: SELECT ACK CHARACTER SETTING.
5. Scan the appropriate two alpha-numeric characters from the keypad in [Appendix E, Keypad](#), that represent the desired character/value in step 1 above. The second character will cause a two-beep indication.
6. Scan the ENTER/EXIT PROGRAMMING MODE barcode to exit Programming Mode.

This completes the procedure. See [Table 8](#) for some examples of how to set this feature.

Table 8. ACK Character Setting Examples

| STEP | ACTION | EXAMPLES | | | |
|------|---|-------------|-------------|-------------|-------------|
| 1 | Desired Character/Value | ACK | \$ | @ | > |
| 2 | Hex equivalent | 0x06 | 0x24 | 0x40 | 0x3E |
| 3 | Scan ENTER/EXIT PROGRAMMING MODE | | | | |
| 4 | Scan SELECT ACK CHARACTER SETTING | | | | |
| 5 | Scan Two Characters From Appendix E, Keypad | '0' and '6' | '2' and '4' | '4' and '0' | '3' AND 'E' |
| 6 | Scan ENTER/EXIT PROGRAMMING MODE | | | | |

ACK Character — cont.

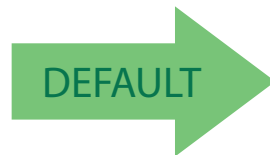
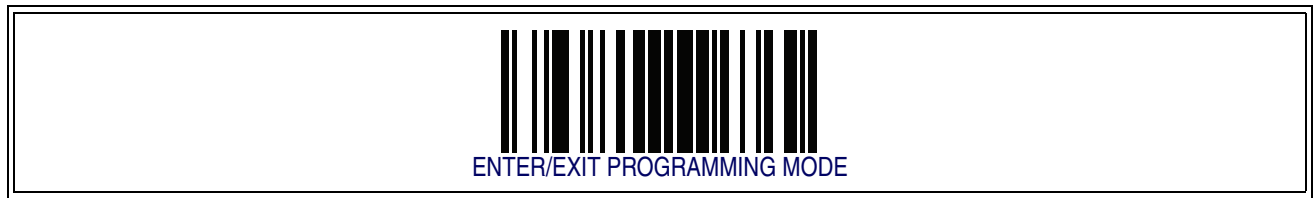

0x06 'ACK' Character

NAK Character

This setting specifies an ASCII character or hex value to be used as the NAK character. ASCII characters or any hex value from 0 to 0xFF can be selected.



NOTE

Setting to previously defined characters such as XON, XOFF, or host commands conflicts with normal operation of these characters. 8-bit data is not recognized when the option [Data Bits](#) has been set as 7 Data Bits.

To set this feature:

1. Determine the desired character or value.
2. Use the [ASCII Chart](#) on the inside back cover of this manual to find the hex equivalent for the desired character/value.
3. Scan the ENTER/EXIT PROGRAMMING MODE barcode to enter Programming Mode.
4. Scan the barcode: SELECT NAK CHARACTER SETTING.
5. Scan the appropriate two alpha-numeric characters from the keypad in [Appendix E, Keypad](#), that represent the desired character/value in step 1 above. The second character will cause a two-beep indication.
6. Scan the ENTER/EXIT PROGRAMMING MODE barcode to exit Programming Mode.

This completes the procedure. See [Table 9](#) for some examples of how to set this feature.

Table 9. NAK Character Setting Examples

| STEP | ACTION | EXAMPLES | | | |
|------|---|-------------|-------------|-------------|-------------|
| 1 | Desired Character/Value | NAK | \$ | @ | > |
| 2 | Hex equivalent | 0x15 | 0x24 | 0x40 | 0x3E |
| 3 | Scan ENTER/EXIT PROGRAMMING MODE | | | | |
| 4 | Scan SELECT ACK CHARACTER SETTING | | | | |
| 5 | Scan Two Characters From Appendix E, Keypad | '1' and '5' | '2' and '4' | '4' and '0' | '3' AND 'E' |
| 6 | Scan ENTER/EXIT PROGRAMMING MODE | | | | |

NAK Character – cont.

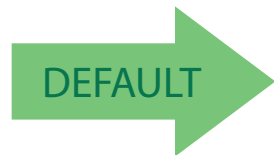
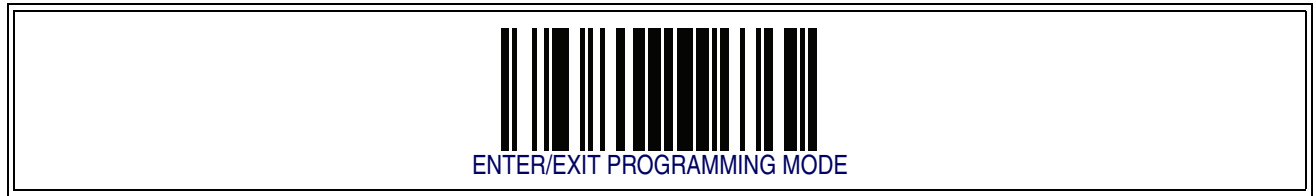

0x15 'NAK' Character

ACK NAK Timeout Value

This option specifies the amount of time the reader waits for an ACK character from the host following label transmission. The selectable timeout range is 200 milliseconds to 15,000ms (15 seconds) in 200ms increments. A selection of 0 disables the timeout.

To set this value:

1. Determine the desired setting in milliseconds.
2. Divide the desired setting by 200 (setting is in 200ms increments). Pad the result with leading zeroes to yield two digits. For example: 0 = 00, 5 = 05, 20 = 20, etc.
3. Scan the ENTER/EXIT PROGRAMMING MODE barcode to enter Programming Mode.
4. Scan the barcode: SELECT ACK NAK TIMEOUT VALUE SETTING.
5. Scan the appropriate two digits from the keypad in [Appendix E, Keypad](#), that represent the duration which was determined in the steps above. You will hear a two-beep indication after the last character.



If you make a mistake before the last character, scan the CANCEL barcode to abort and not save the entry string. You can then start again at the beginning.

NOTE

6. Scan the ENTER/EXIT PROGRAMMING MODE barcode to exit Programming Mode.

This completes the procedure. See [Table 10](#) for some examples of how to set this feature.

Table 10. ACK NAK Timeout Value Setting Examples

| STEP | ACTION | EXAMPLES | | | |
|------|---|-------------|------------------|-------------------|-------------------|
| 1 | Desired Setting | 200ms | 1,000ms (1 sec.) | 5200ms (5.2 sec.) | 15,000ms (1 sec.) |
| 2 | Divide by 200 | 01 | 05 | 26 | 75 |
| 3 | Scan ENTER/EXIT PROGRAMMING MODE | | | | |
| 4 | Scan SELECT ACK NAK TIMEOUT VALUE SETTING | | | | |
| 5 | Scan Two Characters From Appendix E, Keypad | '0' and '1' | '0' and '5' | '2' and '6' | '7' and '5' |
| 7 | Scan ENTER/EXIT PROGRAMMING MODE | | | | |

ACK NAK Timeout Value – cont.

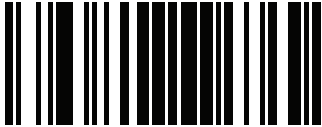
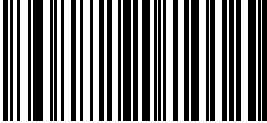
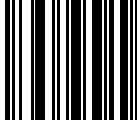
| | |
|--|---|
|  ENTER/EXIT PROGRAMMING MODE | |
|  Select ACK NAK Timeout Value Setting | |
| Make a mistake? Scan the CANCEL barcode to abort and not save the entry string. You can then start again at the beginning. |  CANCEL |

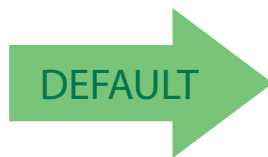

01 ACK NAK Timeout value is 200ms

ACK NAK Retry Count

This feature specifies the number of times the reader retries a label transmission due to a retry condition. The selectable range is from 1 to 254 retries. A selection of 0 disables the count, and a selection of 255 specifies unlimited retries.

To set this feature:

1. Determine the desired setting.
2. Pad the number with leading zeroes to yield three digits. For example: 0 = 000, 5 = 005, 20 = 020, etc.
3. Scan the ENTER/EXIT PROGRAMMING MODE barcode to enter Programming Mode.
4. Scan the barcode: SELECT ACK NAK RETRY COUNT SETTING.
5. Scan the appropriate three digits from the keypad in [Appendix E, Keypad](#), that represent the number which was determined in the steps above. You will hear a two-beep indication after the last character.



If you make a mistake before the last character, scan the CANCEL barcode to abort and not save the entry string. You can then start again at the beginning.

NOTE

6. Scan the ENTER/EXIT PROGRAMMING MODE barcode to exit Programming Mode.

This completes the procedure. See [Table 11](#) for some examples of how to set this feature.

Table 11. ACK NAK Retry Count Setting Examples

| STEP | ACTION | EXAMPLES | | | |
|------|---|---------------------|------------------|------------------|-------------------|
| 1 | Desired Setting | Disable Retry Count | 3 Retries | 54 Retries | Unlimited Retries |
| 2 | Pad with leading zero(es) | 000 | 003 | 054 | 255 |
| 3 | Scan ENTER/EXIT PROGRAMMING MODE | | | | |
| 4 | Scan SELECT ACK NAK RETRY COUNT SETTING | | | | |
| 5 | Scan Three Characters From Appendix E, Keypad | '0', '0' and '0' | '0', '0' and '3' | '0', '5' and '4' | '2', '5' and '5' |
| 6 | Scan ENTER/EXIT PROGRAMMING MODE | | | | |

ACK NAK Retry Count — cont.

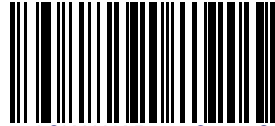
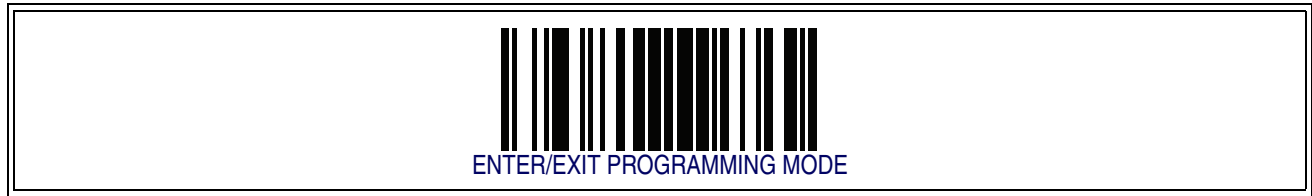

Select ACK NAK Retry Count Setting

Make a mistake? Scan the CANCEL barcode to abort and not save the entry string. You can then start again at the beginning.

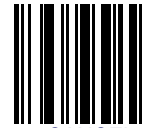

CANCEL



ACK NAK Error Handling

This feature specifies the method the reader uses to handle receive errors detected while waiting for an ACK character from the host.



Options are:

- Ignore errors detected
- Process error as valid ACK character
- Process error as valid NAK character

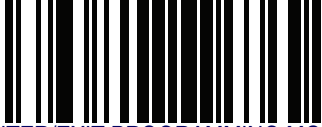
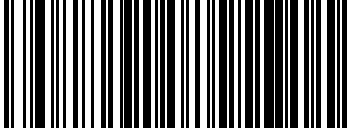
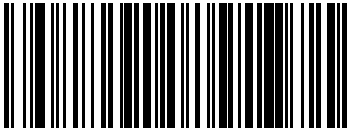

Indicate Transmission Failure

This option enables/disables the reader's ability to sound an error beep to indicate a transmission failure while in ACK/NAK mode.

| | |
|--|--|
|  ENTER/EXIT PROGRAMMING MODE | |
| |  Indicate Transmission Failure = Disable Indication |
|  Indicate Transmission Failure = Enable Indication |  |

Disable Character

Specifies the value of the RS-232 host command used to disable the reader. ASCII characters or any hex value from 0 to 0xFF can be selected.



NOTE

Setting to previously defined characters such as XON, XOFF, or host commands conflicts with normal operation of these characters. 8-bit data is not recognized when the option [Data Bits](#) has been set as 7 Data Bits.

To set the value:

1. Determine the desired character or value. A setting of 0xFF indicates the the Disable Character is not used (not available).
2. Use the [ASCII Chart](#) on the inside back cover of this manual to find the hex equivalent for the desired character/value.
3. Scan the ENTER/EXIT PROGRAMMING MODE barcode to enter Programming Mode.
4. Scan the barcode: SELECT DISABLE CHARACTER SETTING.
5. Scan the appropriate two alpha-numeric characters from the keypad in [Appendix E, Keypad](#), that represent the desired character/value in step 1 above. The second character will cause a two-beep indication.
6. Scan the ENTER/EXIT PROGRAMMING MODE barcode to exit Programming Mode.

This completes the procedure. See [Table 12](#) for some examples of how to set this feature.

Table 12. Disable Character Setting Examples

| STEP | ACTION | EXAMPLES | | | |
|------|---|-------------|-------------|-------------|--------------------------|
| 1 | Desired character/value | 'd' | 'j' | 'D' | Disable Command Not Used |
| 2 | Hex equivalent | 0x64 | 0x7D | 0x44 | 0xFF |
| 3 | Scan ENTER/EXIT PROGRAMMING MODE | | | | |
| 4 | Scan SELECT DISABLE CHARACTER VALUE SETTING | | | | |
| 5 | Scan Two Characters From Appendix E, Keypad | '6' and '4' | '7' and 'D' | '4' and '4' | 'F' AND 'F' |
| 6 | Scan ENTER/EXIT PROGRAMMING MODE | | | | |

Disable Character – cont.

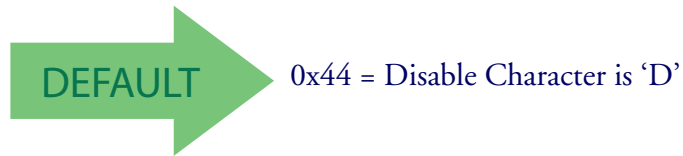
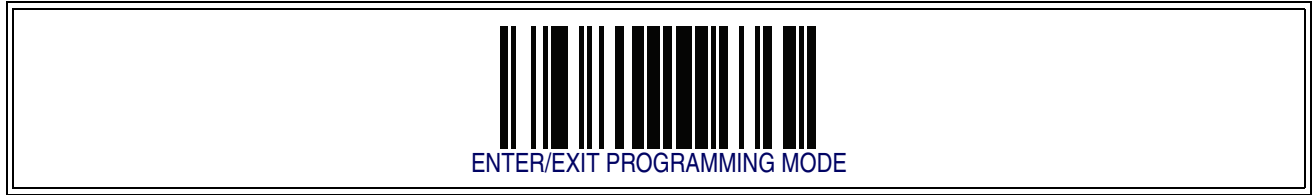

Enable Character

Specifies the value of the RS-232 host command used to enable the reader. ASCII characters or any hex value from 0 to 0xFF can be selected.



NOTE

Setting to previously defined characters such as XON, XOFF, or host commands conflicts with normal operation of these characters. 8-bit data is not recognized when the option [Data Bits](#) has been set as 7 Data Bits.

To set this feature:

Determine the desired character or value. A setting of 0xFF indicates the the Enable Character is not used (not available).

1. Determine the desired character or value.
2. Use the [ASCII Chart](#) on the inside back cover of this manual to find the hex equivalent for the desired character/value.
3. Scan the ENTER/EXIT PROGRAMMING MODE barcode to enter Programming Mode.
4. Scan the barcode: SELECT ENABLE CHARACTER SETTING.
5. Scan the appropriate two alpha-numeric characters from the keypad in [Appendix E, Keypad](#), that represent the desired character/value in step 2 above. The second character will cause a two-beep indication.
6. Scan the ENTER/EXIT PROGRAMMING MODE barcode to exit Programming Mode.

This completes the procedure. See [Table 13](#) for some examples of how to set this feature.

Table 13. Enable Character Setting Examples

| STEP | ACTION | EXAMPLES | | | |
|------|---|-------------|-------------|-------------|-------------------------|
| 1 | Desired character/value | 'e' | '}' | 'E' | Enable Command Not Used |
| 2 | Hex equivalent | 0x65 | 0x7D | 0x45 | 0xFF |
| 3 | Scan ENTER/EXIT PROGRAMMING MODE | | | | |
| 4 | Scan SELECT DISABLE CHARACTER VALUE SETTING | | | | |
| 5 | Scan Two Characters From Appendix E, Keypad | '6' and '5' | '7' and 'D' | '4' and '5' | 'F' AND 'F' |
| 6 | Scan ENTER/EXIT PROGRAMMING MODE | | | | |

Enable Character – cont.

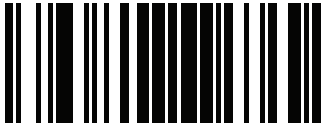
| |
|--|
|  ENTER/EXIT PROGRAMMING MODE |
|--|

| |
|--|
|  Select Enable Character Setting |
|--|

| |
|--|
| |
|--|

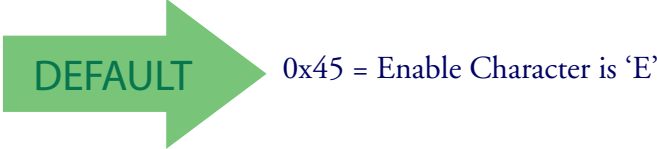

NOTES

Chapter 7

Keyboard Interface

Introduction

Use the programming barcodes in this chapter to select options for USB Keyboard and Wedge Interfaces.

Standard Factory Settings

Reference [Appendix B, Standard Defaults](#) for a listing of standard factory settings.

Scancode Tables

Information about control character emulation which applies to keyboard interfaces is listed in [Appendix F, Scancode Tables](#).

Country Mode

This feature specifies the country/language supported by the keyboard. Only the following interfaces support ALL Country Modes.

- USB Keyboard (without alternate key encoding)
- AT, PS/2 25-286, 30-286, 50, 50Z, 60, 70, 80, 90 & 95 w/Std Key Encoding
- Keyboard Wedge for IBM AT PS2 with standard key encoding but without external keyboard
- AT, PS/2 25-286, 30-286, 50, 50Z, 60, 70, 80, 90 & 95 without Alternate Key
- Keyboard Wedge for IBM AT PS2 without alternate key encoding but without external keyboard

All other interfaces support ONLY the following Country Modes: U.S., Belgium, Britain, France, Germany, Italy, Spain, Sweden.

| | |
|--|---|
|  ENTER/EXIT PROGRAMMING MODE | |
|  |  Country Mode = U.S. |
|  Country Mode = Belgium | |
| |  Country Mode = Britain |
|  Country Mode = Croatia | Supports only the interfaces listed in theCountry Mode feature description. |
| Supports only the interfaces listed in theCountry Mode feature description. |  Country Mode = Czech Republic |

Country Mode — continued

| | |
|--|---|
|  ENTER/EXIT PROGRAMMING MODE | |
|  Country Mode = Denmark | Supports only the interfaces listed in theCountry Mode feature description. |
| |  Country Mode = France |
|  Country Mode = Germany | |
| Supports only the interfaces listed in theCountry Mode feature description. |  Country Mode = Hungary |
|  Country Mode = Italy | |
| Supports only the interfaces listed in theCountry Mode feature description. |  Country Mode = Japanese 106-key |
|  Country Mode = Norway | Supports only the interfaces listed in theCountry Mode feature description. |

Country Mode – continued

| | |
|---|---|
|  ENTER/EXIT PROGRAMMING MODE | |
|  Country Mode = Poland | Supports only the interfaces listed in theCountry Mode feature description. |
| Supports only the interfaces listed in theCountry Mode feature description. |  Country Mode = Portugal |
|  Country Mode = Romania | Supports only the interfaces listed in theCountry Mode feature description. |
| Supports only the interfaces listed in theCountry Mode feature description. |  Country Mode = Slovakia |
|  Country Mode = Spain | |
| |  Country Mode = Sweden |
|  Country Mode = Switzerland | Supports only the interfaces listed in theCountry Mode feature description. |

Caps Lock State

This option specifies the format in which the reader sends character data. This applies to keyboard wedge interfaces. This does not apply when an alternate key encoding keyboard is selected.

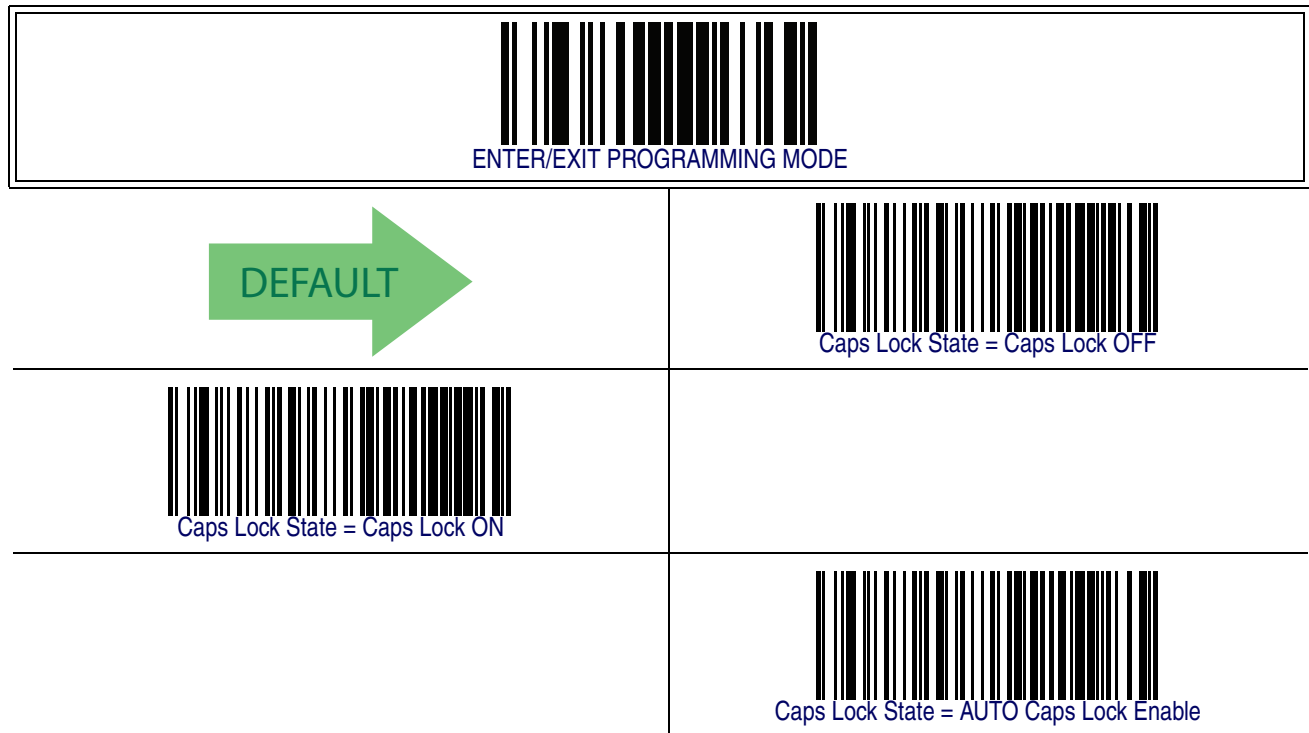

Numlock

This option specifies the setting of the Numbers Lock (Numlock) key while in keyboard wedge interface. This only applies to alternate key encoding interfaces. It does not apply to USB keyboard.

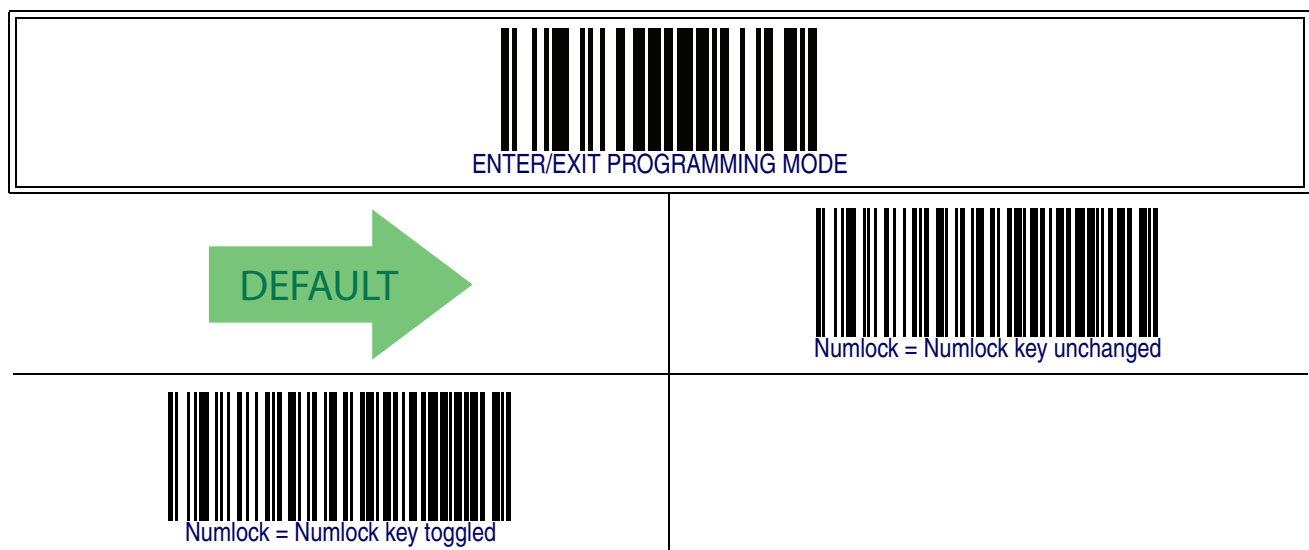

Send Control Characters

This feature Specifies how the reader transmits ASCII control characters to the host. Reference [Appendix F, Scancode Tables](#) for more information about control characters.

Options are as follows:

Control Character 00 – Characters from 00 to 0x1F are sent as control character Ctrl+Keys, special keys are located from 0x80 to 0xA1.

Control Character 01 – Characters from 00 to 0x1F are sent as control character Ctrl+Capital Key, special keys are located from 0x80 to 0xA1.

Control Character 02 – Special keys are located from 00 to 0x1F and characters from 0x80 to 0xFE are intended as an extended ASCII table (Microsoft Windows Codepage 1252 — see [Microsoft Windows Codepage 1252 on page 410](#)).



Wedge Quiet Interval

This option specifies the amount of time to look for keyboard activity before the reader breaks the keyboard connection in order to transmit data to host. The selectable range for this feature is from 0 to 990ms in 10ms increments.



This feature applies **ONLY** to the Keyboard Wedge interface.

NOTE

Follow these instructions to set this feature:

1. Determine the desired setting in milliseconds.
2. Divide the desired setting by 10 (setting is in 10ms increments). Pad the result with leading zeroes to yield two digits. For example: 0 = 00, 5 = 05, 20 = 20, etc.
3. Scan the ENTER/EXIT PROGRAMMING MODE barcode to enter Programming Mode.
4. Scan the barcode: SELECT WEDGE QUIET INTERVAL SETTING.
5. Scan the appropriate two digits from the keypad in [Appendix E, Keypad](#), that represent the duration which was determined in the steps above. You will hear a two-beep indication after the last character.



If you make a mistake before the last character, scan the **CANCEL** barcode to abort and not save the entry string. You can then start again at the beginning.

NOTE

6. Scan the ENTER/EXIT PROGRAMMING MODE barcode to exit Programming Mode.

This completes the procedure to set the Wedge Quiet Interval. See [Table 14](#) for some examples of how to set this feature.

Table 14. Timeout Setting Examples

| STEP | ACTION | EXAMPLES | | | |
|------|---|-------------|-------------|-------------|-------------|
| 1 | Desired Setting | 10ms | 150ms | 600ms | 850ms |
| 2 | Divide by 10 (and pad with leading zeroes) | 01 | 15 | 60 | 85 |
| 3 | Scan ENTER/EXIT PROGRAMMING MODE | | | | |
| 4 | Scan SELECT WEDGE QUIET INTERVAL SETTING | | | | |
| 5 | Scan Two Characters From Appendix E, Keypad | '0' and '1' | '1' and '5' | '6' and '0' | '8' and '5' |
| 6 | Scan ENTER/EXIT PROGRAMMING MODE | | | | |

Wedge Quiet Interval – cont.

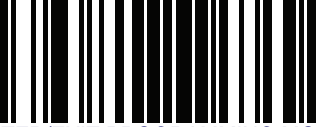
| |
|--|
|  ENTER/EXIT PROGRAMMING MODE |
|--|

| |
|--|
|  Select Wedge Quiet Interval Setting |
|--|

| |
|--|
| |
|--|

Make a mistake? Scan the CANCEL barcode to abort and not save the entry string. You can then start again at the beginning.

| |
|---|
|  CANCEL |
|---|

 10 = Quiet Interval of 100 ms

Intercharacter Delay

This parameter specifies the intercharacter delay between the end of one character and the beginning of the next. The delay can be set within a range of zero (0) to 990 milliseconds in 10ms increments. A setting of zero specifies no delay.



This feature applies **ONLY** to the Keyboard Wedge interface.

NOTE

To set the delay:

1. Determine the desired setting in milliseconds.
2. Divide the desired setting by 10 (setting is in 10ms increments). Pad the result with leading zeroes to yield two digits. For example: 0 = 00, 5 = 05, 20 = 20, etc.
3. Scan the ENTER/EXIT PROGRAMMING MODE barcode to enter Programming Mode.
4. Scan the barcode: SELECT INTERCHARACTER DELAY SETTING.
5. Scan the appropriate two digits from the keypad in [Appendix E, Keypad](#), that represent the duration which was determined in the steps above. You will hear a two-beep indication after the last character.



If you make a mistake before the last character, scan the **CANCEL** barcode to abort and not save the entry string. You can then start again at the beginning.

NOTE



6. Scan the ENTER/EXIT PROGRAMMING MODE barcode to exit Programming Mode.

This completes the procedure. See [Table 14](#) for some examples of how to set this feature.

Table 15. Intercharacter Delay Setting Examples

| STEP | ACTION | EXAMPLES | | | |
|------|--|-------------|-------------|-------------|-------------|
| 1 | Desired Setting | 50ms | 150ms | 600ms | 850ms |
| 2 | Divide by 10 (and pad with leading zeroes to yield two-digits) | 05 | 15 | 60 | 85 |
| 3 | Scan ENTER/EXIT PROGRAMMING MODE | | | | |
| 4 | Scan SELECT INTERCHARACTER DELAY SETTING | | | | |
| 5 | Scan Two Characters From Appendix E, Keypad | '0' and '5' | '1' and '5' | '6' and '0' | '8' and '5' |
| 6 | Scan ENTER/EXIT PROGRAMMING MODE | | | | |

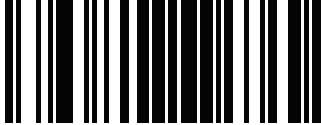
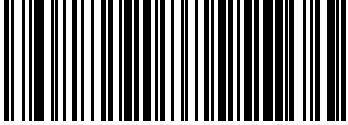
Intercharacter Delay – cont.

| | |
|--|---|
|  ENTER/EXIT PROGRAMMING MODE | |
| |  Intercharacter Delay = No Delay |
|  Select Intercharacter Delay Setting | |
| Make a mistake? Scan the CANCEL barcode to abort and not save the entry string. You can then start again at the beginning. |  CANCEL |

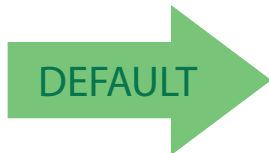

00 = No Intercharacter Delay

Intercode Delay

Specifies the delay between labels transmitted to the host for this interface. The selectable range for this feature is from 0 to 99 seconds.

Follow these instructions to set this feature:

1. Determine the desired setting.
2. Pad the number with leading zeroes to yield two digits. For example: 0 = 00, 5 = 05, 20 = 20, etc
3. Scan the ENTER/EXIT PROGRAMMING MODE barcode to enter Programming Mode.
4. Scan the barcode: SELECT INTERCODE DELAY SETTING.
5. Scan the appropriate two digits from the keypad in [Appendix E, Keypad](#), that represent the duration which was determined in the steps above. You will hear a two-beep indication after the last character.



If you make a mistake before the last character, scan the CANCEL barcode to abort and not save the entry string. You can then start again at the beginning.

NOTE

6. Scan the ENTER/EXIT PROGRAMMING MODE barcode to exit Programming Mode.

This completes the procedure. See [Table 16](#) for some examples of how to set this feature.

Table 16. Wedge Intercode Delay Examples

| STEP | ACTION | EXAMPLES | | | |
|------|---|-------------|-------------|-------------|-------------|
| 1 | Desired Setting | No Delay | 5 Seconds | 60 Seconds | 99 Seconds |
| 2 | Pad with leading zero(es) | 00 | 05 | 60 | 99 |
| 3 | Scan ENTER/EXIT PROGRAMMING MODE | | | | |
| 4 | Scan SELECT INTERCODE DELAY SETTING | | | | |
| 5 | Scan Two Characters From Appendix E, Keypad | '0' and '0' | '0' and '5' | '6' and '0' | '9' AND '9' |
| 7 | Scan ENTER/EXIT PROGRAMMING MODE | | | | |

Intercode Delay – cont.

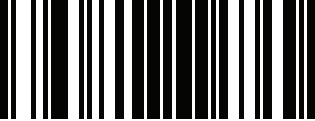
| |
|--|
|  ENTER/EXIT PROGRAMMING MODE |
|--|

| | |
|--|--|
|  Set Intercode Delay | |
|--|--|

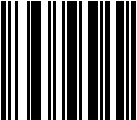
| | |
|--|---|
| Make a mistake? Scan the CANCEL barcode to abort and not save the entry string. You can then start again at the beginning. |  CANCEL |
|--|---|

 00 = No Wedge Intercode Delay

USB Keyboard Speed

This option specifies the USB poll rate for a USB keyboard.





This feature applies **ONLY** to the USB Keyboard interface.

NOTE

| | |
|--|--|
|  ENTER/EXIT PROGRAMMING MODE | |
|  DEFAULT |  USB Keyboard Speed = 1ms |
|  USB Keyboard Speed = 2ms | |
| |  USB Keyboard Speed = 3ms |
|  USB Keyboard Speed = 4ms | |
| |  USB Keyboard Speed = 5ms |

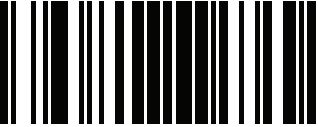
USB Keyboard Speed – continued

| | |
|--|--|
|  ENTER/EXIT PROGRAMMING MODE | |
|  USB Keyboard Speed = 6ms | |
| |  USB Keyboard Speed = 7ms |
|  USB Keyboard Speed = 8ms | |
| |  USB Keyboard Speed = 9ms |
|  USB Keyboard Speed = 10ms | |

Chapter 8

USB-OEM Interface

Introduction

Feature settings for USB interfaces differ depending upon which host type the reader will be connected with. Use the feature settings in this chapter and [Chapter 9, IBM 46XX Interface](#) to specifically configure for the USB-OEM interface. Other USB interfaces are included in the appropriate chapter for their host type.

Standard Factory Settings

Reference [Appendix B, Standard Defaults](#) for a listing of standard factory settings.

USB-OEM Device Usage

The USB-OEM protocol allows for the reader to be identified as one of two different types of barcode scanners. Depending on what other scanners you may already have connected to a USB-OEM POS, you may need to change this setting to enable all devices to communicate.

Options are:

- Table Top Scanner
- Handheld Scanner



It may be necessary to switch device usage when connecting two readers/scanners of the same type to a POS system.

NOTE



USB-OEM Interface Options

This setting provides for an interface specific control mechanism..
Options are:

- Obey — Obey Scanner Configuration Host Commands
- Ignore — Ignore Scanner Configuration Host Commands



NOTES

Chapter 9

IBM 46XX Interface

Introduction

Use the barcodes in this section to configure programmable features for available IBM 46XX interfaces.

IBM Standard Factory Settings

Reference [Appendix B, Standard Defaults](#) for a listing of standard factory settings.

46xx Number of Host Resets

Specifies how many consecutive resets are processed before the reader starts a five-second period to allow the user to enter Programming Mode and configure the reader. The configurable range for this feature is 1 to 15 resets.

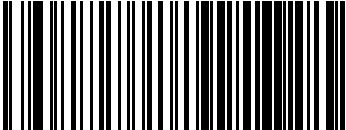
| | |
|---|--|
|  ENTER/EXIT PROGRAMMING MODE | |
| |  46xx Number of Host Resets = 1 |
|  46xx Number of Host Resets = 2 | |
| |  46xx Number of Host Resets = 3 |
|  46xx Number of Host Resets = 4 | |
| |  46xx Number of Host Resets = 5 |
|  46xx Number of Host Resets = 6 |  DEFAULT |

46xx Number of Host Resets – cont.

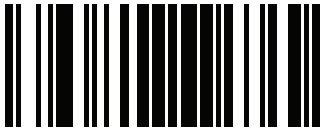
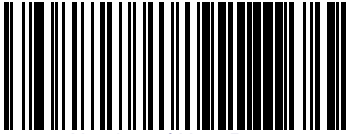
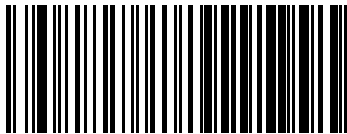
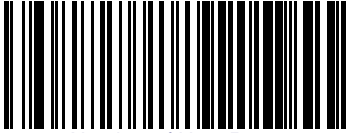
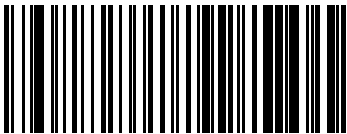
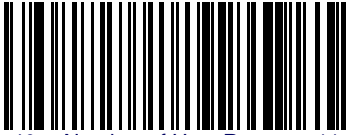
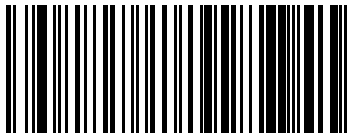
| | |
|--|---|
|  ENTER/EXIT PROGRAMMING MODE | |
| |  46xx Number of Host Resets = 7 |
|  46xx Number of Host Resets = 8 | |
| |  46xx Number of Host Resets = 9 |
|  46xx Number of Host Resets = 10 | |
| |  46xx Number of Host Resets = 11 |
|  46xx Number of Host Resets = 12 | |

46xx Number of Host Resets – cont.

| | |
|--|---|
|  ENTER/EXIT PROGRAMMING MODE | |
| |  46xx Number of Host Resets = 13 |
|  46xx Number of Host Resets = 14 | |
| |  46xx Number of Host Resets = 15 |

Transmit Labels in Code 39 Format

This feature enable/disables translation to Code 39 before transmitting label data to an IBM-46XX or a USB-OEM host. Only the symbology identifier is modified for the translation. The data is not converted to Code 39 or verified to be valid for Code 39.

Options are:

IBM Standard Format – Send labels in standard IBM format.

Code 39 Format – Translate the following symbologies to Code 39:

- USB-OEM: Code128, Code 93, and Codabar
- IBM-Port 5B: Code 128, Code 93, and Codabar
- IBM-Port 9B: Code 93 and Codabar

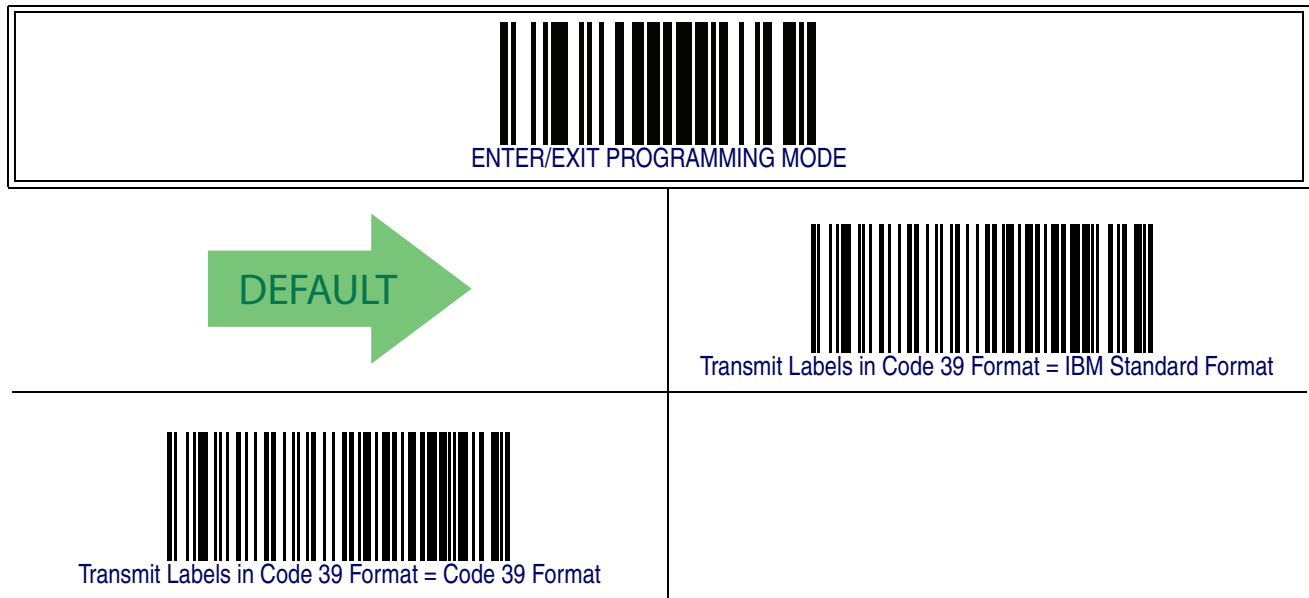

IBM 46XX Interface Options

This setting provides for an interface specific control mechanism..
Options are:

- Obey — Obey Scanner Configuration Host Commands
- Ignore — Ignore Scanner Configuration Host Commands



Chapter 10

Wand Emulation Interface

Introduction

This chapter provides feature/settings configuration for the Wand Emulation interface.

Wand Emulation Standard Factory Settings

Reference [Appendix B, Standard Defaults](#) for a listing of standard factory settings.

Wand Idle State

This feature specifies the level of the Wand output signal when the reader is idle.



NOTE

TTL logic levels:
0V <= Low <= 0.7V
2.4V <= High <= 5.25V

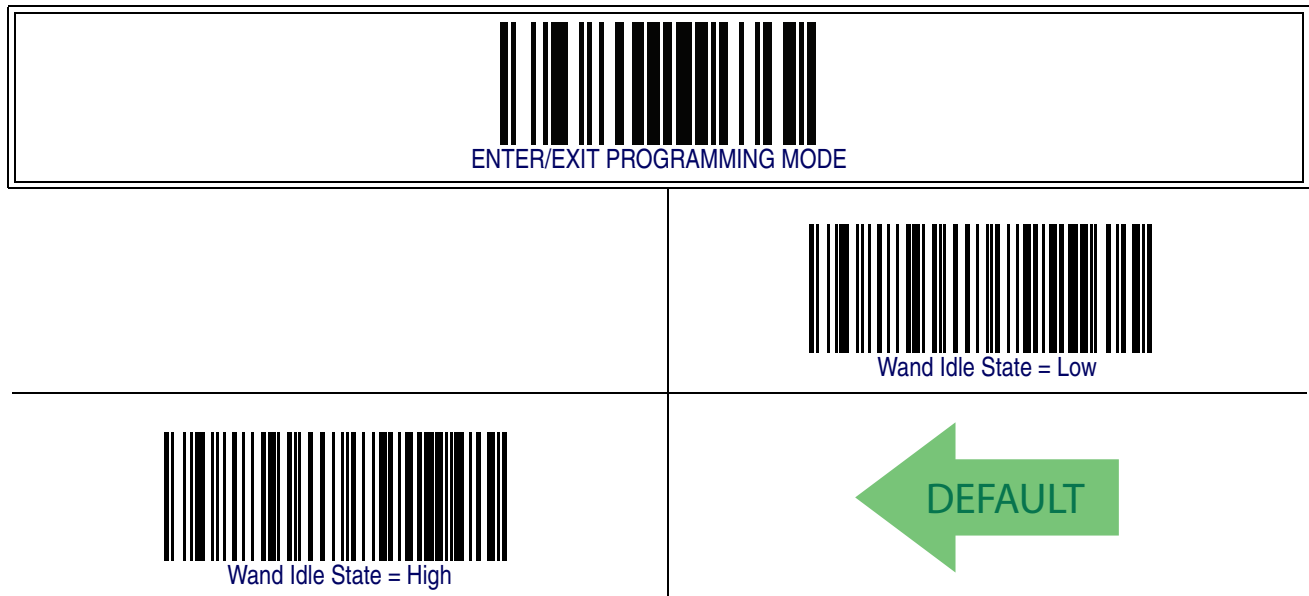

Wand Polarity

This option specifies the polarity of the Wand output signal. Choices are:

- Quiet zones and spaces are high, bars are low
- Quiet zones and spaces are low, bars are high



NOTE

TTL logic levels:
0V <= Low <= 0.7V
2.4V <= High <= 5.25V

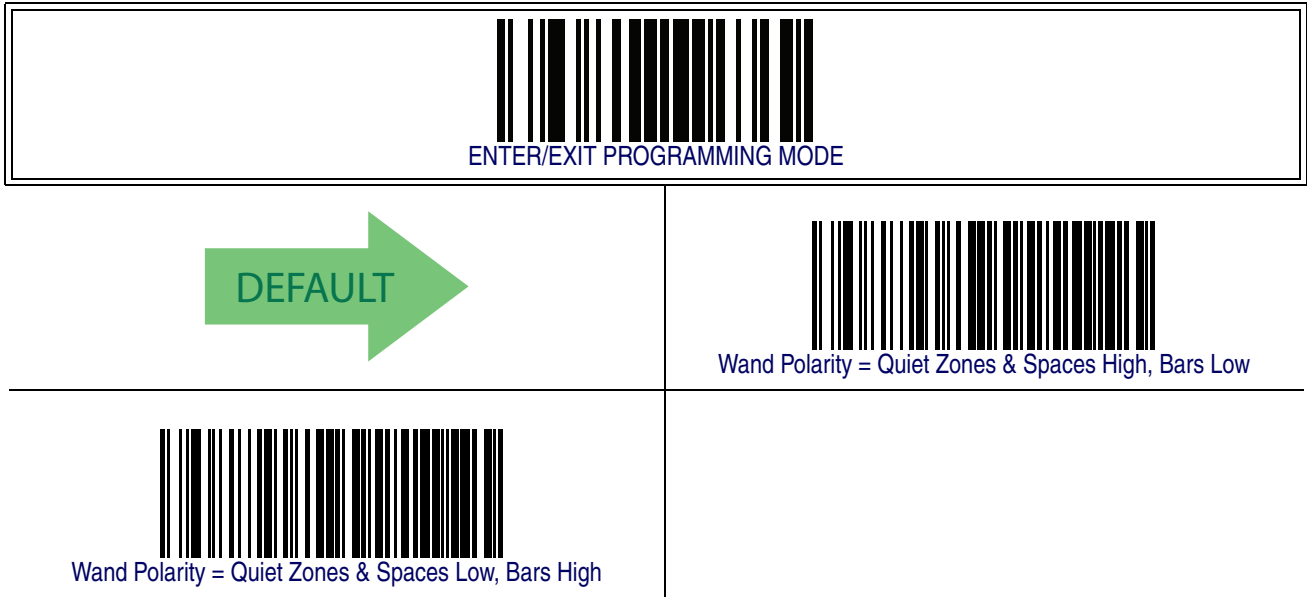

Wand Signal Speed

This feature specifies the speed of the Wand output signal per nominal bar or space. Choices are:

- 330 microseconds
- 660 microseconds



Label Symbology Conversion

When this feature is enabled for the Wand Emulation interface, all barcode labels are converted to a single symbology.

Options are:

- No conversion
- Convert to Code 39 symbology
- Convert to Code 39 Full ASCII
- Convert to Code 128 symbology



Transmit Noise

This option specifies the leading/trailing noise for the Wand interface.
 Choices are:

- Disable (no leading/trailing noise)
- Enable leading noise
- Enable trailing noise
- Enable leading and trailing noise



NOTES

Chapter 11

Data Editing

Data Editing Overview



It is not recommended to use these features with IBM interfaces.

CAUTION

When a barcode is scanned, additional information can be sent to the host computer along with the barcode data. This combination of barcode data and supplementary user-defined data is called a “message string.” The features in this chapter can be used to build specific user-defined data into a message string.

There are several types of selectable data characters that can be sent before and after scanned data. You can specify if they should be sent with all symbologies, or only with specific symbologies. [Figure 4](#) shows the available elements you can add to a message string:

Figure 4. Breakdown of a Message String

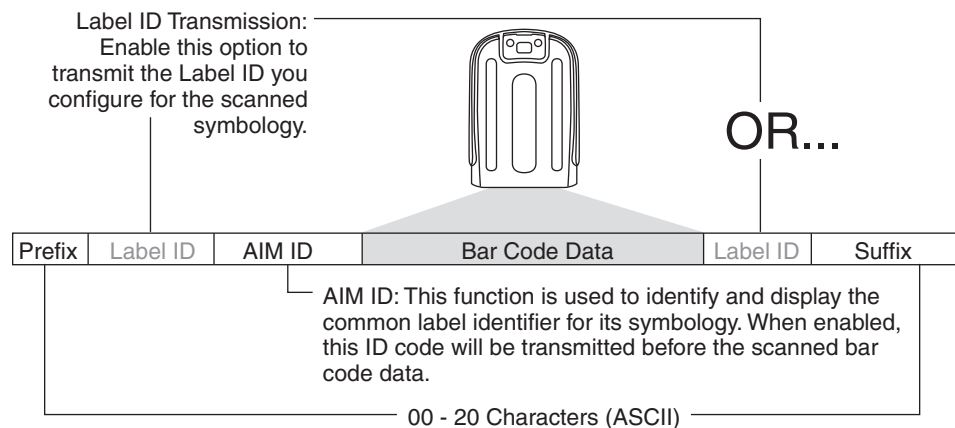

NOTE

Additional advanced editing is available. See the Advanced Formatting features in the Datalogic Aladdin Configuration Application or contact [Technical Support on page 3](#) for more information.

Please Keep In Mind...

- Modifying a message string is not a mandatory requirement. Data editing is sophisticated feature allowing highly customizable output for advanced users. Factory default settings for data editing is typically set to NONE.
- A prefix or suffix may be applied (reference the [Symbologies](#) chapter for these settings) across all symbologies (set via the Global features in this chapter).
- You can add any character from the [ASCII Chart](#) (from 00-FF) on the inside back cover of this manual as a prefix, suffix or Label ID.
- Enter prefixes and suffixes in the order in which you want them to appear on the output.

Global Prefix/Suffix

Up to 20 ASCII characters may be added as a prefix (in a position before the barcode data) and/or as a suffix (in a position following the barcode data) as indicated in [Figure 5](#).

Figure 5. Prefix and Suffix Positions

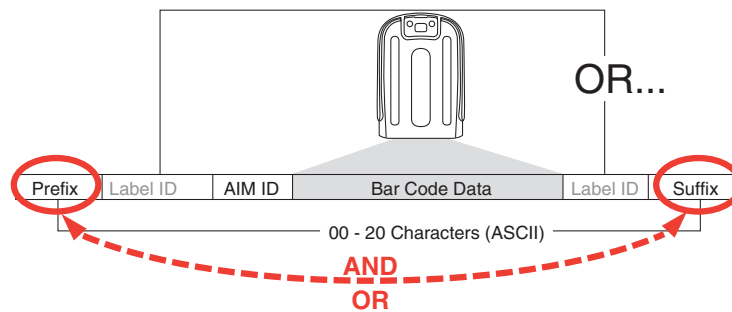

Example: Setting a Prefix

In this example, we'll set a prefix for all symbologies.

1. Determine which ASCII character(s) are to be added to scanned barcode data. In this example, we'll add a dollar sign ('\$') as a prefix.
2. Scan the ENTER/EXIT barcode.
3. Scan the SET GLOBAL PREFIX barcode.
4. Reference the ASCII Chart on the inside back cover of this manual, to find the hex value assigned to the desired character. The corresponding hex number for the '\$' character is 24. To enter this selection code, scan the '2' and '4' barcodes from [Appendix E, Keypad](#).



NOTE

If you make a mistake before the last character, scan the CANCEL barcode to abort and not save the entry string. You can then start again at the beginning.



5. If less than the expected string of 20 characters are selected, scan the ENTER/EXIT barcode to terminate the string.

6. Scan the ENTER/EXIT barcode once again to exit Programming Mode.
7. The resulting message string would appear as follows:

Scanned barcode data:12345

Resulting message string output: \$12345

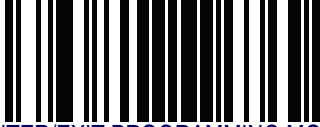
This option sets up to 20 characters each from the set of ASCII characters or any hex value from 00 to FF. To configure this feature, scan the ENTER/EXIT barcode to place the unit in Programming Mode, then the “Set Global Prefix” or “Set Global Suffix,” barcode followed by the digits (in hex) from the Alphanumeric characters in [Appendix E, Keypad](#) representing your desired character(s). If less than the expected string of 20 characters are selected, scan the ENTER/EXIT barcode to terminate the string. Reference the section, [Example: Setting a Prefix on page 104](#), for more information. Exit programming mode by scanning the ENTER/EXIT barcode once again.

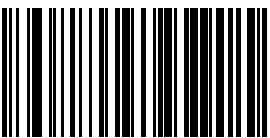
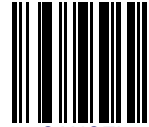
| | |
|---|---|
|  ENTER/EXIT PROGRAMMING MODE | |
| |  Set Global Prefix |
|  Set Global Suffix | |
| <p>Make a mistake? Scan the CANCEL barcode to abort and not save the entry string. You can then start again at the beginning.</p> | |
|  CANCEL | |

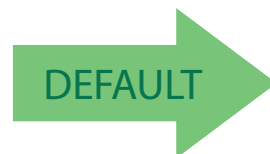

No Global Prefix
Global Suffix = 0x0D (CR)

Global AIM ID



This feature enables/disables addition of AIM IDs for all symbology types.

NOTE

AIM label identifiers (as opposed to custom characters you select yourself as with label identifiers) can be included with scanned barcode data. AIM label identifiers consist of three characters as follows:

- A close brace character (ASCII ‘}’), followed by...
- A code character (see the table below), followed by...
- A modifier character (the modifier character is symbol dependent).

| SYMBOLGY | CHAR | SYMBOLGY | CHAR |
|---------------------|----------------|---|----------------|
| UPC/EAN | E ^a | Code 128/GS1-128 | C |
| Code 39 and Code 32 | A | GS1 DataBar Omnidirectional, GS1 DataBar Expanded | e |
| Codabar | F | Standard 2 of 5 | S |
| Interleaved 2 of 5 | I | ISBN | X ^b |
| Code 93 | G | Code 11 | H |

^{a.} UPC-A and UPC-E labels are converted to EAN 13 when adding AIM IDs.

^{b.} ISBN (X with a 0 modifier character)

Figure 6. AIM ID

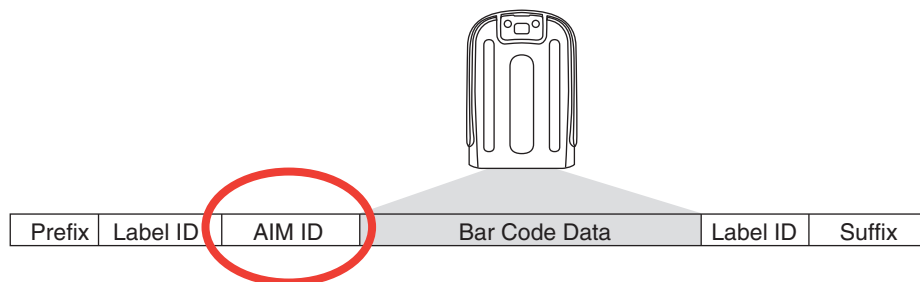

Global AIM ID – continued

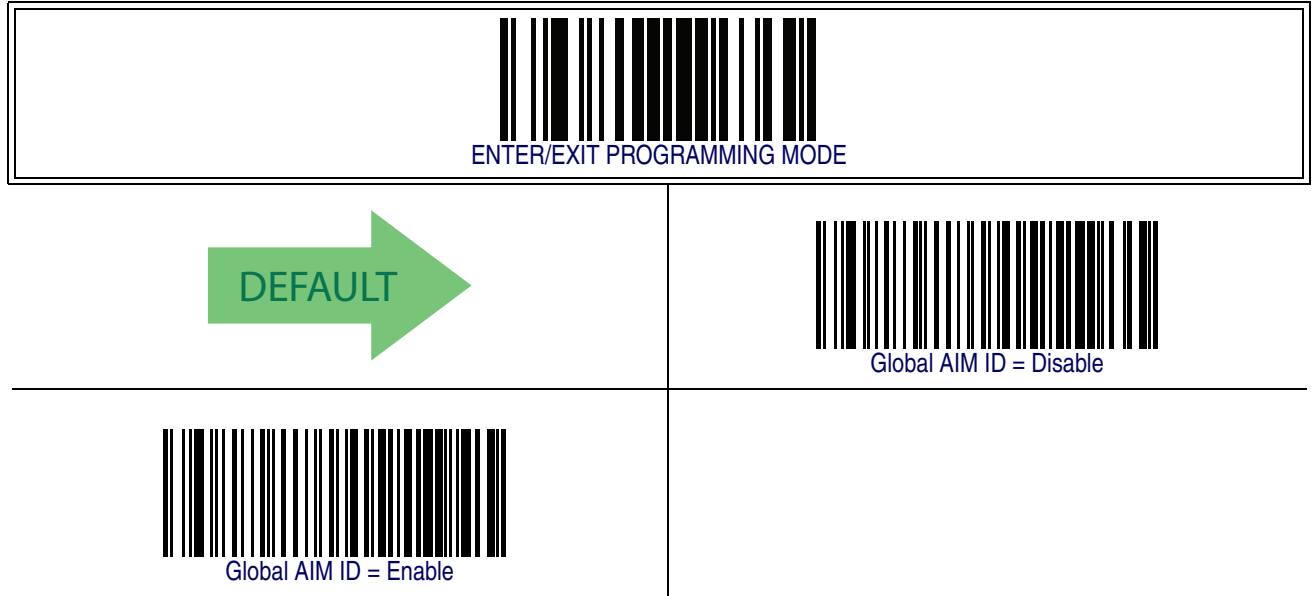

GS1-128 AIM ID

If Global AIM ID is disabled, the AIM ID for GS1-128 can be enabled/disabled independently. The AIM ID for GS1-128 is a]C1,]C2 or]C3. AIM IDs for other symbologies can be enabled/disabled independently as well. Contact Customer Support for assistance.



Label ID

A Label ID is a customizable code of up to three ASCII characters (each can be one of hex 0x01-0xFF), used to identify a barcode (symbology) type. It can be appended previous to or following the transmitted barcode data depending upon how this option is enabled. This feature provides options for configuring custom Label IDs as a pre-loaded set (see [Label ID Pre-loaded Sets on page 110](#)) or individually per symbology (see [Label ID: Set Individually Per Symbology on page 112](#)). If you wish to program the reader to always include an industry standard label identifier for ALL symbology types, see the previous feature [Global AIM ID on page 106](#).

Label ID: Pre-loaded Sets

The reader supports two pre-loaded sets of Label IDs. [Table 17](#) shows the USA set and the EU set.



CAUTION

When changing from one Label ID set to another, all other imager configuration settings, including the host interface type, will be erased and set to the factory defaults. Any custom configuration or custom defaults will be lost.

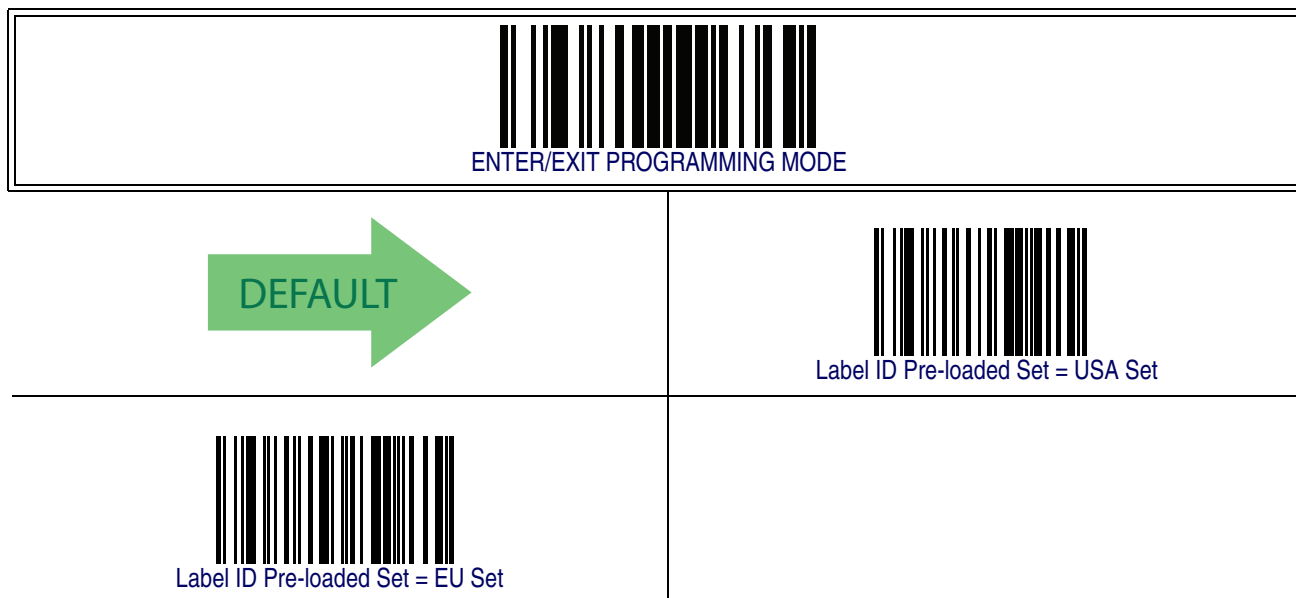

Table 17. Label ID Pre-loaded Sets

| Symbology | USA Label ID set | | EU Label ID set | |
|-----------------------------|------------------|-----------|-----------------|-------------------|
| | ASCII character | Hex value | ASCII character | Hexidecimal value |
| ABC Codabar | S | 530000 | S | 530000 |
| Anker Plessey | o | 6F0000 | o | 6F0000 |
| CODABAR | % | 250000 | R | 520000 |
| Codablock F | l | 6C0000 | m | 6D0000 |
| Code 39 CIP | Y | 590000 | Y | 590000 |
| Code 93 | & | 260000 | U | 550000 |
| CODE11 | CE | 434500 | b | 620000 |
| CODE128 | # | 230000 | T | 540000 |
| CODE32 | A | 410000 | X | 580000 |
| CODE39 | * | 2A0000 | V | 560000 |
| CODE4 | 4 | 340000 | 4 | 340000 |
| CODE5 | j | 6A0000 | j | 6A0000 |
| CODE93 | & | 260000 | U | 550000 |
| DATALOGIC 2OF5 | s | 730000 | s | 730000 |
| EAN13 | F | 460000 | B | 420000 |
| EAN13 P2 | F | 460000 | L | 4C0000 |
| EAN13 P5 | F | 460000 | M | 4D0000 |
| EAN13 P8 | F | 460000 | # | 230000 |
| EAN8 | FF | 464600 | A | 410000 |
| EAN8 P2 | FF | 464600 | J | 4A0000 |
| EAN8 P5 | FF | 464600 | K | 4B0000 |
| EAN8 P8 | FF | 464600 | * | 2A0000 |
| FOLLETT 2OF5 | O | 4F0000 | O | 4F0000 |
| GS1 DATABAR EXPANDED | RX | 525800 | t | 740000 |
| GS1 DATABAR LIMITED | RL | 524C00 | v | 760000 |
| GS1 DATABAR OMNIDIRECTIONAL | R4 | 523400 | u | 750000 |
| GS1-128 | | 000000 | k | 6B0000 |
| GTIN | G | 470000 | \$A | 244100 |
| GTIN2 | G2 | 473200 | \$B | 244200 |

| Symbology | USA Label ID set | | EU Label ID set | |
|---------------------------|------------------|--------|-----------------|--------|
| | | | | |
| GTIN5 | G5 | 473500 | \$C | 244300 |
| GTIN8 | G8 | 473800 | \$D | 244400 |
| I2OF5 | i | 690000 | N | 4E0000 |
| IATA | IA | 494100 | & | 260000 |
| Industrial 2 of 5 | W | 570000 | W | 570000 |
| Interleaved 2 of 5 CIP HR | e | 650000 | e | 650000 |
| ISBN | l | 490000 | @ | 400000 |
| ISBT128 | f | 660000 | f | 660000 |
| ISSN | n | 6E0000 | n | 6E0000 |
| MSI | @ | 400000 | Z | 5A0000 |
| Plessey | a | 610000 | a | 610000 |
| S25 | s | 730000 | P | 500000 |
| UPCA | A | 410000 | C | 430000 |
| UPCA P2 | A | 410000 | F | 460000 |
| UPCA P5 | A | 410000 | G | 470000 |
| UPCA P8 | A | 410000 | Q | 510000 |
| UPCE | E | 450000 | D | 440000 |
| UPCE P2 | E | 450000 | H | 480000 |
| UPCE P5 | E | 450000 | I | 490000 |
| UPCE P8 | E | 450000 | E | 450000 |

Label ID: Set Individually Per Symbology

To configure a Label ID individually for a single symbology:

1. Scan the ENTER/EXIT barcode.
2. Select Label ID position as either BEFORE (Enable as Prefix) or AFTER (Enable as suffix) by scanning the appropriate barcode in the section [Label ID Control on page 114](#). Reference [Figure 7](#) for Label ID positioning options if multiple identification features are enabled.
3. Scan a barcode to select the symbology for which you wish to configure a custom Label ID from the section [Label ID Symbology Selection, starting on page 115](#).
4. Determine the desired character(s) (you may choose up to three) which will represent the Label ID for the selected symbology.
5. Turn to the [ASCII Chart](#) on the inside back cover of this manual and find the equivalent hex digits associated with your choice of Label ID. For example, if you wish to select an equal sign (=) as a Label ID, the chart indicates its associated hex characters as 3D. Turn to [Keypad, starting on page 395](#) and scan the barcodes representing the hex characters determined. For the example given, the characters '3' and 'D' would be scanned. More examples of Label ID settings are provided in [Table 18](#).



If you make a mistake before the last character, scan the CANCEL barcode to abort and not save the entry string. You can then start again at the beginning.

NOTE

6. Scan the ENTER/EXIT barcode to exit Label ID entry.
7. Scan the ENTER/EXIT barcode once again to exit Programming Mode.

This completes the steps to configure a Label ID for a given symbology.

Figure 7. Label ID Position Options

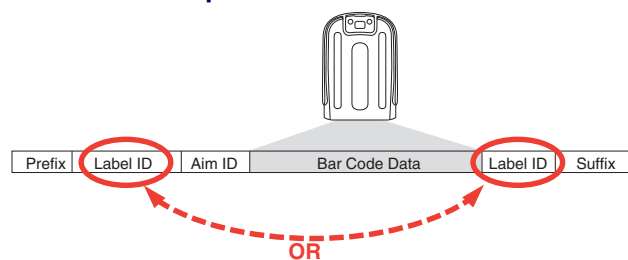

Label ID – continued

Table 18. Label ID Examples

| STEP | ACTION | EXAMPLES | | | |
|----------------|--|-----------------------------------|-------------------|--------------------|------------------|
| 1. | Scan the ENTER/EXIT barcode | (Scanner enters Programming Mode) | | | |
| 2. | Determine placement of the Label ID characters BEFORE or AFTER with regard to scanned data using Label ID Control on page 114 | Enable as Prefix | Enable as Suffix | Enable as Prefix | Enable as Suffix |
| 3. | Scan the barcode selecting the symbology type you wish to designate label ID characters for using Label ID Symbology Selection, starting on page 115. | GS1 DataBar Omnidirectional | Code 39 | Interleaved 2 of 5 | Code 32 |
| 4. | Custom Label ID example (desired characters): | D B * | = C 3 | + | P H |
| 5. | Find hex equivalents from the ASCII table (inside back cover), then scan in these digits/characters using the barcodes in the section: Keypad, starting on page 395. If you make a mistake before the last character, scan the CANCEL barcode to abort and not save the entry string. You can then start again at the beginning. | 44 42 2A | 3D 43 33 | 2B | 50 48 |
| 6. | Scan the ENTER/EXIT barcode | (Scanner exits Label ID entry) | | | |
| 7. | Scan the ENTER/EXIT barcode once again | (Scanner exits Programming Mode) | | | |
| Result: | | | | | |
| | | DB*[barcode data] | [barcode data]=C3 | +[barcode data] | [barcode data]PH |

Label ID – continued

Label ID Control

This option controls whether a Label ID is disabled, or sent as a prefix or suffix for a given symbology type.

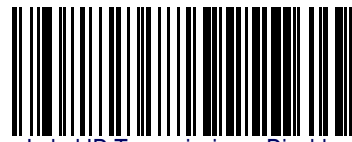
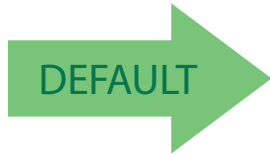
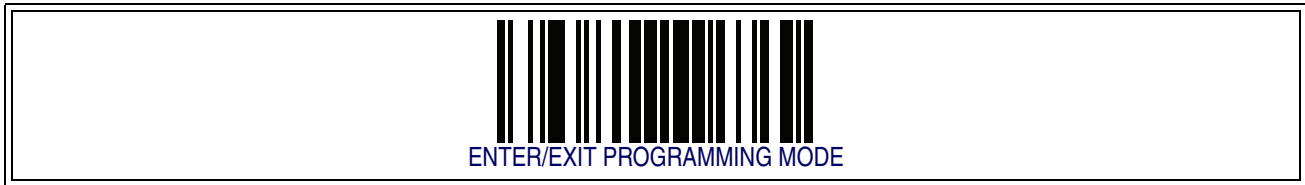

Label ID Transmission = Disable

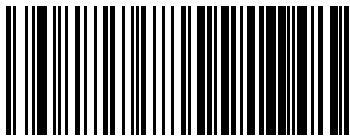

Label ID Transmission = Enable as Prefix

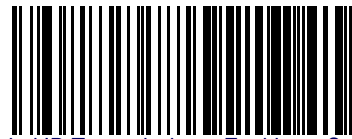

Label ID Transmission = Enable as Suffix

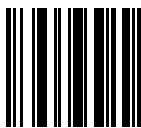

CANCEL

Make a mistake? Scan the CANCEL barcode to abort and not save the entry string. You can then start again at the beginning.

Label ID – continued

Label ID Symbology Selection

This option selects the symbology for which a Label ID is to be configured. See [Label ID on page 109](#) for full instructions.

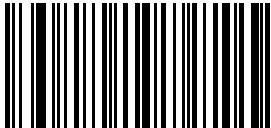
| | |
|--|---|
|  ENTER/EXIT PROGRAMMING MODE | |
| |  Set UPC-A Label ID Character(s) |
|  Set UPC-A/P2 Label ID Character(s) | |
| |  Set UPC-A/P5 Label ID Character(s) |
|  Set UPC-A/GS1-128 Label ID Character(s) | |
| |  Set UPC-E Label ID Character(s) |
|  Set UPC-E/P2 Label ID Character(s) | |

Label ID – continued

Label ID Symbology Selection – continued

This option selects the symbology for which a Label ID is to be configured. See [Label ID on page 109](#) for full instructions.

| | |
|---|---|
|  ENTER/EXIT PROGRAMMING MODE | |
| |  Set UPC-E/P5 Label ID Character(s) |
|  Set UPC-E/GS1-128 Label ID Character(s) | |
| |  Set EAN 13 Label ID Character(s) |
|  Set EAN 13/P2 Label ID Character(s) | |
| |  Set EAN 13/P5 Label ID Character(s) |
|  Set EAN 13/GS1-128 Label ID Character(s) | |

Label ID – continued

Label ID Symbology Selection – continued

This option selects the symbology for which a Label ID is to be configured. See [Label ID on page 109](#) for full instructions.

| | |
|--|---|
|  ENTER/EXIT PROGRAMMING MODE | |
| |  Set EAN 8 Label ID Character(s) |
|  Set EAN 8/P2 Label ID Character(s) | |
| |  Set EAN 8/P5 Label ID Character(s) |
|  Set EAN 8/GS1-128 Label ID Character(s) | |
| |  Set GTIN Label ID Character(s) |
|  Set GTIN/P2 Label ID Character(s) | |

Label ID – continued

Label ID Symbology Selection – continued

This option selects the symbology for which a Label ID is to be configured. See [Label ID](#) on page 109 for full instructions.

| | |
|---|--|
|  ENTER/EXIT PROGRAMMING MODE | |
| |  Set GTIN/P5 Label ID Character(s) |
|  Set GTIN/GS1-128 Label ID Character(s) | |
| |  Set GS1 DataBar Omnidirectional Label ID Character(s) |
|  Set GS1 DataBar Expanded Label ID Character(s) | |
| |  Set GS1 DataBar Limited Label ID Character(s) |
|  Set Code 39 Label ID Character(s) | |

Label ID – continued

Label ID Symbology Selection – continued

This option selects the symbology for which a Label ID is to be configured. See [Label ID on page 109](#) for full instructions.

| | |
|---|---|
|  ENTER/EXIT PROGRAMMING MODE | |
|  Set Code 32 Label ID Character(s) | |
| |  Set Code 39 CIP Label ID Character(s) |
|  Set Code 128 Label ID Character(s) | |
| |  Set GS1-128 Label ID Character(s) |
|  Set Interleaved 2 of 5 Label ID Character(s) | |
| |  Set Interleaved 2 of 5 CIP HR Label ID Character(s) |
|  Set Datalogic 2 of 5 Label ID Character(s) | |

Label ID — continued

Label ID Symbology Selection — continued

This option selects the symbology for which a Label ID is to be configured. See [Label ID on page 109](#) for full instructions.

| | |
|--|---|
|  ENTER/EXIT PROGRAMMING MODE | |
| |  Set Codabar Label ID Character(s) |
|  Set ABC Codabar Label ID Character(s) | |
| |  Set Code 11 Label ID Character(s) |
|  Set Standard 2 of 5 Label ID Character(s) | |
| |  Set Industrial 2 of 5 Label ID Character(s) |
|  Set ISSN Label ID Character(s) | |

Label ID – continued

Label ID Symbology Selection – continued

This option selects the symbology for which a Label ID is to be configured. See [Label ID on page 109](#) for full instructions.

| | |
|--|--|
|  ENTER/EXIT PROGRAMMING MODE | |
|  Set IATA Label ID Character(s) | |
| |  Set Concatinated ISBT 128 Label ID Character(s) |
|  Set MSI Label ID Character(s) | |
| |  Set Plessey Label ID Character(s) |
|  Set Anker Plessey Label ID Character(s) | |
| |  Set Code 93 Label ID Character(s) |

Label ID – continued

Label ID Symbology Selection – continued

This option selects the symbology for which a Label ID is to be configured. See [Label ID on page 109](#) for full instructions.

| | |
|--|--|
|  ENTER/EXIT PROGRAMMING MODE | |
|  Set Codablock F Label ID Character(s) | |
| |  Set Code 4 Label ID Character(s) |
|  Set Code 5 Label ID Character(s) | |
| |  Set Follett 2 of 5 Label ID Character(s) |

Case Conversion

This feature allows conversion of the case of all alphabetic characters to upper or lower case.



Case conversion affects **ONLY** scanned barcode data, and does not affect Label ID, Prefix, Suffix, or other appended data.

NOTE

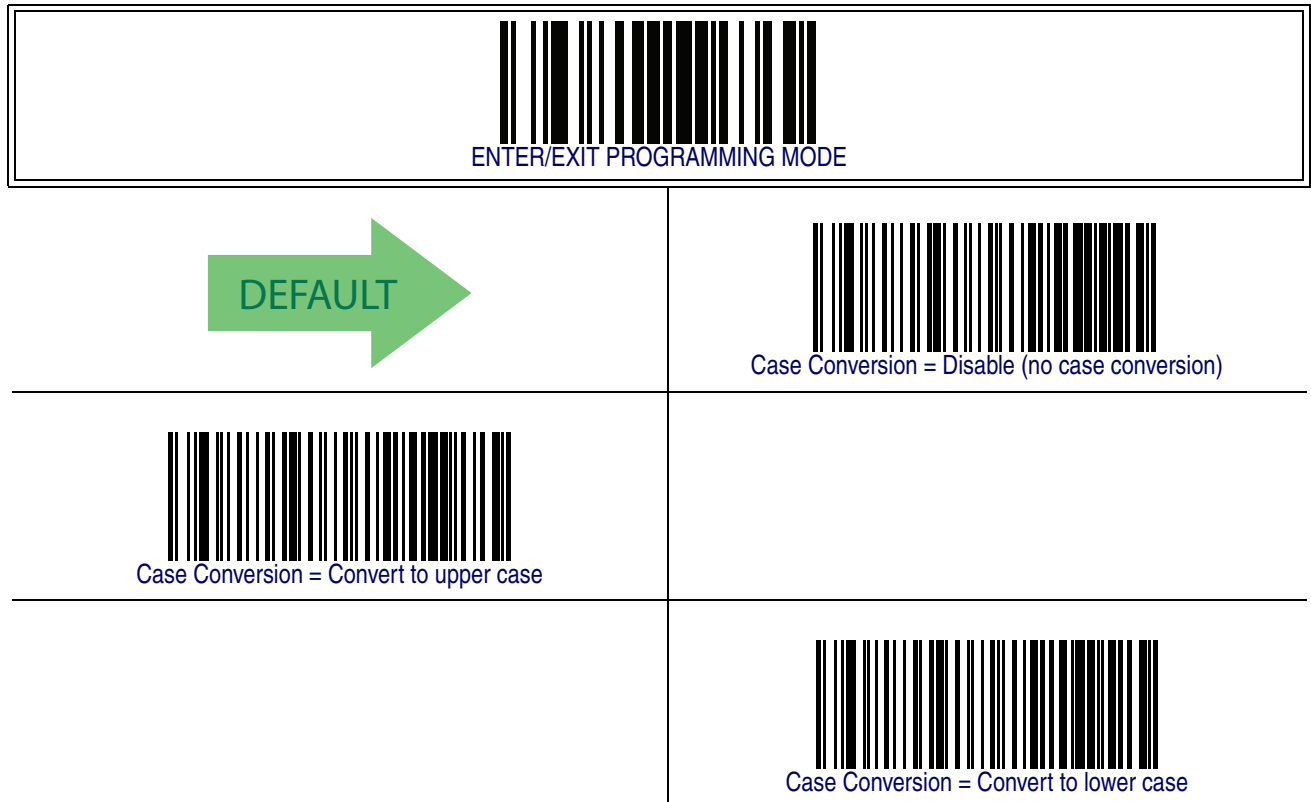

Character Conversion

Character conversion is an eight byte configuration item. The eight bytes are 4 character pairs represented in hexadecimal ASCII values. The first character in the pair is the character that will be converted. The second character in the pair is the character to convert to. If the character to convert in a pair is FF, then no conversion is done.

For example, if you have the character conversion configuration item set to the following: 41423132FFFFFF

The first pair is 4142 or AB (41 hex is an ASCII capital A, 42 hex is an ASCII capital B) and the second pair is 3132 or 12 (31 hex is an ASCII 1, 32 is an ASCII 2). The other two pairs are FFFF and FFFF.

With the label, AB12BA21, it would look as follows after the character conversion: BB22BB22.

The A characters were converted to B characters and the 1 characters were converted to 2 characters. Nothing is done with the last two character pairs, since they are all FF.

To set Character Conversion:

1. Scan the ENTER/EXIT barcode.
2. Scan the “Configure Character Conversion” barcode.
3. Determine the desired string. Sixteen positions must be determined as in the above example. Next, turn to the ASCII Chart on the inside back cover of this manual and find the equivalent hex digits needed to fulfill the string.
4. Turn to [Appendix E, Keypad](#) and scan the barcodes representing the hex characters determined in the previous step.
5. Scan the ENTER/EXIT barcode to exit Programming Mode.



NOTE

If less than the expected string of 16 characters are selected, scan the ENTER/EXIT barcode twice to accept the selections and exit Programming Mode.

Character Conversion – continued

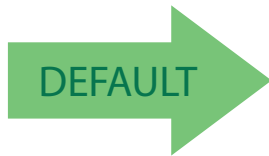
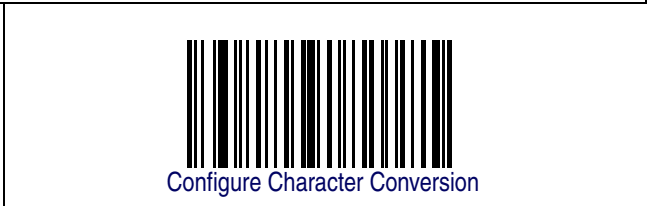
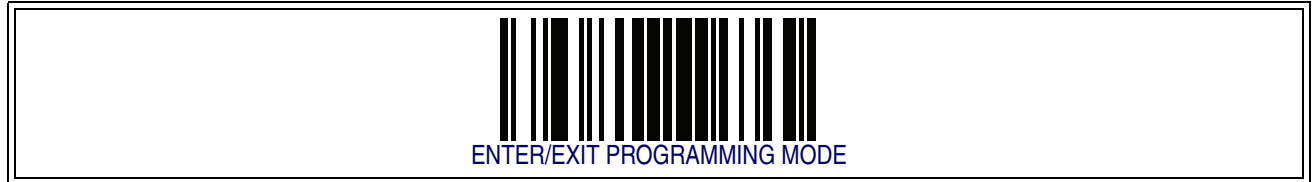

0xFFFFFFFFFFFFFFFF
(No character conversion)

NOTES

Chapter 12

Symbologies

Introduction

The reader supports the following symbologies (barcode types). Options for each symbology are included in this chapter.

Symbologies

- UPC-A
- UPC-E
- GTIN Formatting
- EAN 13 (JAN 13)
- EAN 8 (JAN 8)
- Add-Ons
- GS1 DataBar™ Omnidirectional
- GS1 DataBar™ Expanded
- GS1 DataBar™ Limited
- Code 39
- Code 32 (Italian Pharmaceutical)
- Code 39 CIP (French Pharmaceutical)
- Code 128
- GS1-128
- Interleaved 2 of 5 (I 2 of 5)
- Interleaved 2 of 5 CIP HR
- Datalogic 2 of 5
- Codabar
- ABC Codabar
- Code 11
- Standard 2 of 5
- Industrial 2 of 5
- IATA
- ISBT 128
- MSI
- Plessey
- Code 93
- Codablock F
- Code 4
- Code 5
- Follett 2 of 5

Standard Factory Settings for Symbologies

Default settings are indicated at each feature/option with a green arrow. Also reference [Appendix B, Standard Defaults](#) for a listing of the most widely used set of standard factory settings. That section also provides space to record any custom settings needed or implemented for your system.

Disable All Symbologies

Scan this label to disable all symbologies.

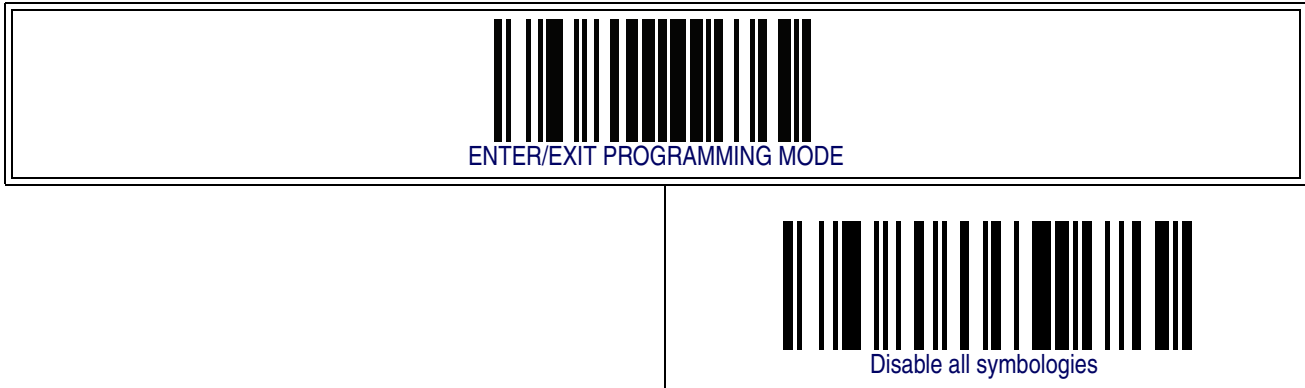

Coupon Control

This feature is used to control the method of processing coupon labels.

Options are:

- Allow all — allow all coupon barcodes to be decoded
- Enable only UPC/EAN — enables only UPC/EAN coupon decoding
- Enable only GS1 DataBar — enables only GS1 DataBar coupon decoding

To set this feature:

1. Scan the SWITCH bar code.
2. Scan either the enable or disable bar code below. You'll need to cover any unused barcodes on this and the facing page to ensure that the reader sees only the barcode you intend to scan.
3. Complete the programming sequence by scanning the SWITCH barcode.



| | |
|---|--|
|  ENTER/EXIT PROGRAMMING MODE | |
| |  Coupon Control = Allow all |
|  Coupon Control = Enable only UPC/EAN |  |
| |  Coupon Control = Enable only GS1 DataBar |

UPC-A

The following options apply to the UPC-A symbology.

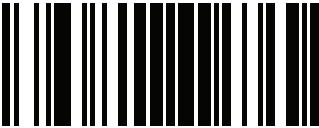

UPC-A Enable/Disable

When disabled, the reader will not read UPC-A barcodes.

| | |
|--|---|
|  ENTER/EXIT PROGRAMMING MODE | |
| |  UPC-A = Disable |
|  UPC-A = Enable |  DEFAULT |

UPC-A Check Character Transmission

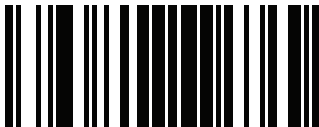
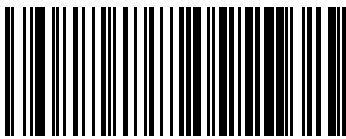
Enable this option to transmit the check character along with UPC-A barcode data.

| | |
|--|---|
|  ENTER/EXIT PROGRAMMING MODE | |
| |  UPC-A Check Character Transmission = Don't Send |
|  UPC-A Check Character Transmission = Send |  DEFAULT |

UPC-A – cont.

Expand UPC-A to EAN-13

Expands UPC-A data to the EAN-13 data format. Selecting this feature also changes the symbology ID to match those required for EAN-13.



UPC-A Number System Character Transmission

This feature enables/disables transmission of the UPC-A number system character.

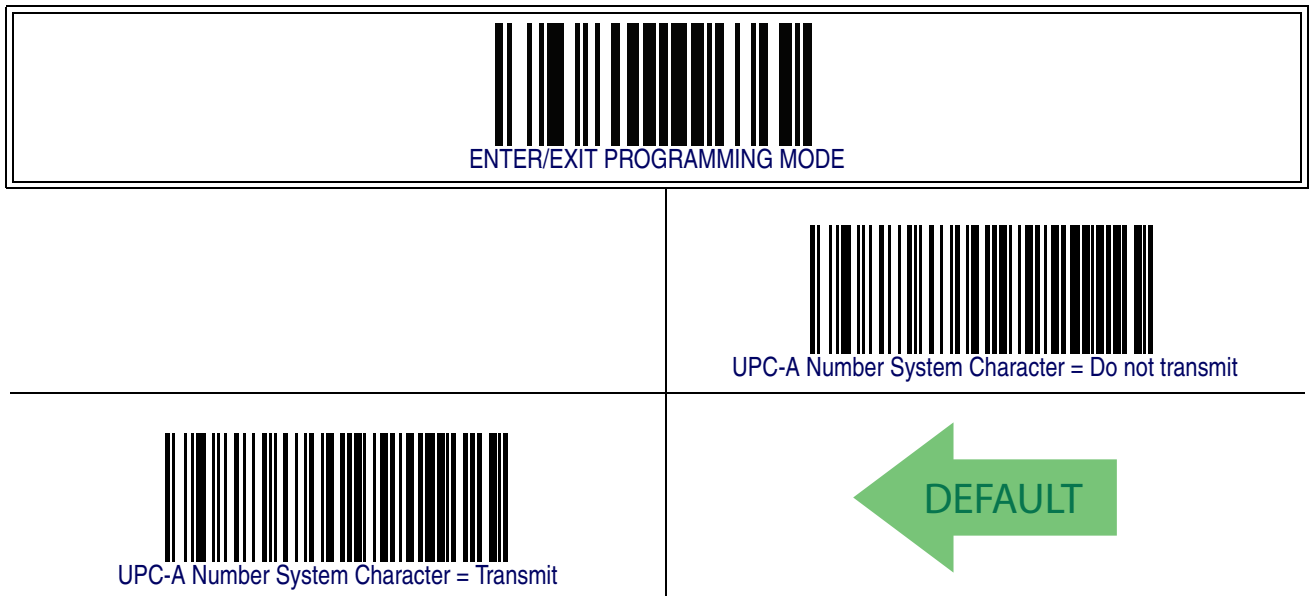

UPC-A – cont.

In-Store Minimum Reads

This feature specifies the minimum number of consecutive times an in-store label must be decoded before it is accepted as good read.

In-store labels are defined as UPC-A labels with a number-system character of 2 or 4 as well as EAN 8 and EAN 13 labels with a Flag1 character of 2 or an EAN 13 label starting with the three characters '980'.

| | |
|---|--|
|  ENTER/EXIT PROGRAMMING MODE | |
| |  In-Store Minimum Reads = 1 |
|  In-Store Minimum Reads = 2 |  |
| |  In-Store Minimum Reads = 3 |
|  In-Store Minimum Reads = 4 | |

UPC-E

The following options apply to the UPC-E symbology.

UPC-E Enable/Disable

When disabled, the reader will not read UPC-E barcodes.



UPC-E Check Character Transmission

Enable this option to transmit the check character along with UPC-E barcode data.

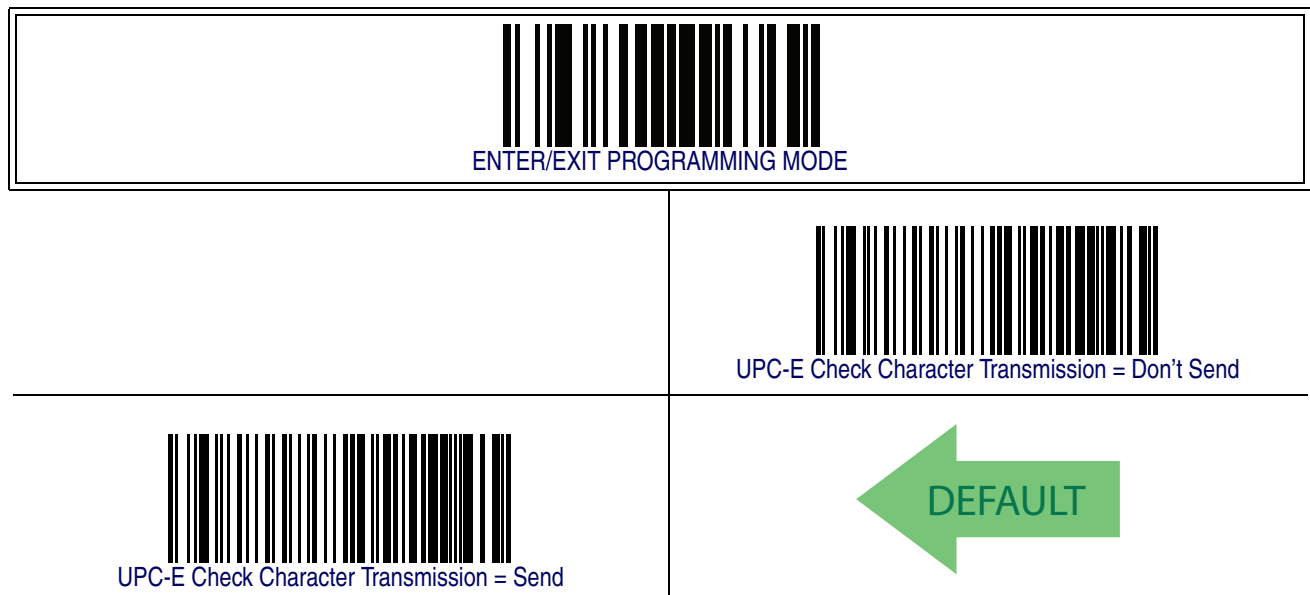

UPC-E — cont.

Expand UPC-E to EAN-13

Expands UPC-E data to the EAN-13 data format. Selecting this feature also changes the symbology ID to match those required for EAN-13.

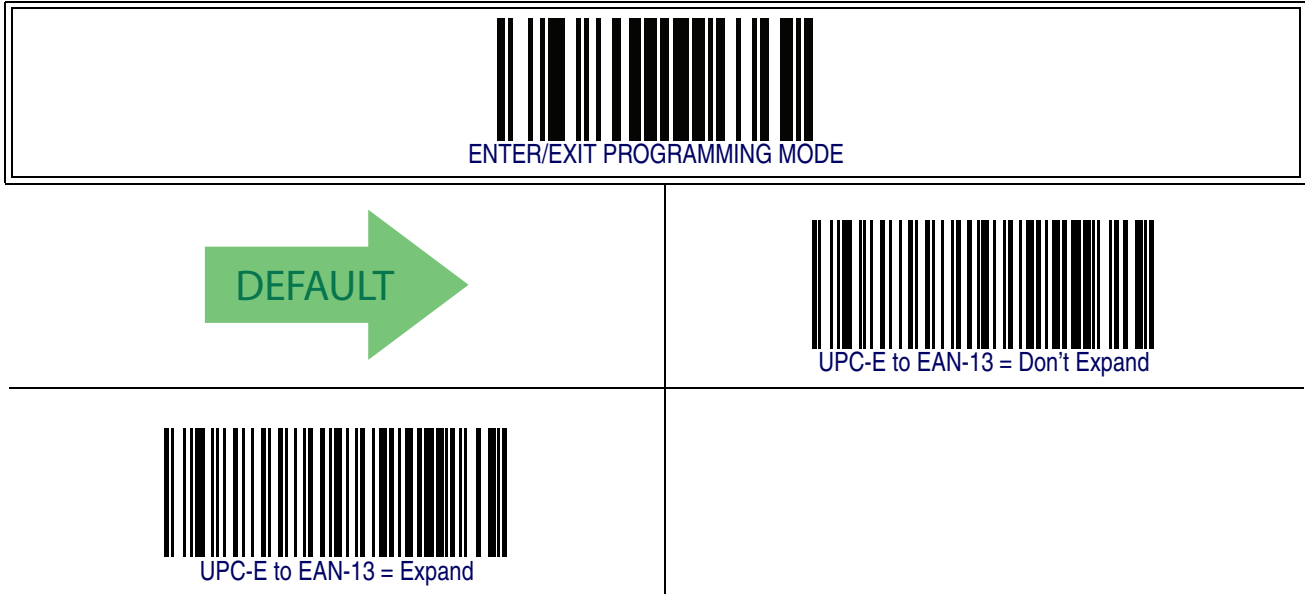

Expand UPC-E to UPC-A

Expands UPC-E data to the UPC-A data format.

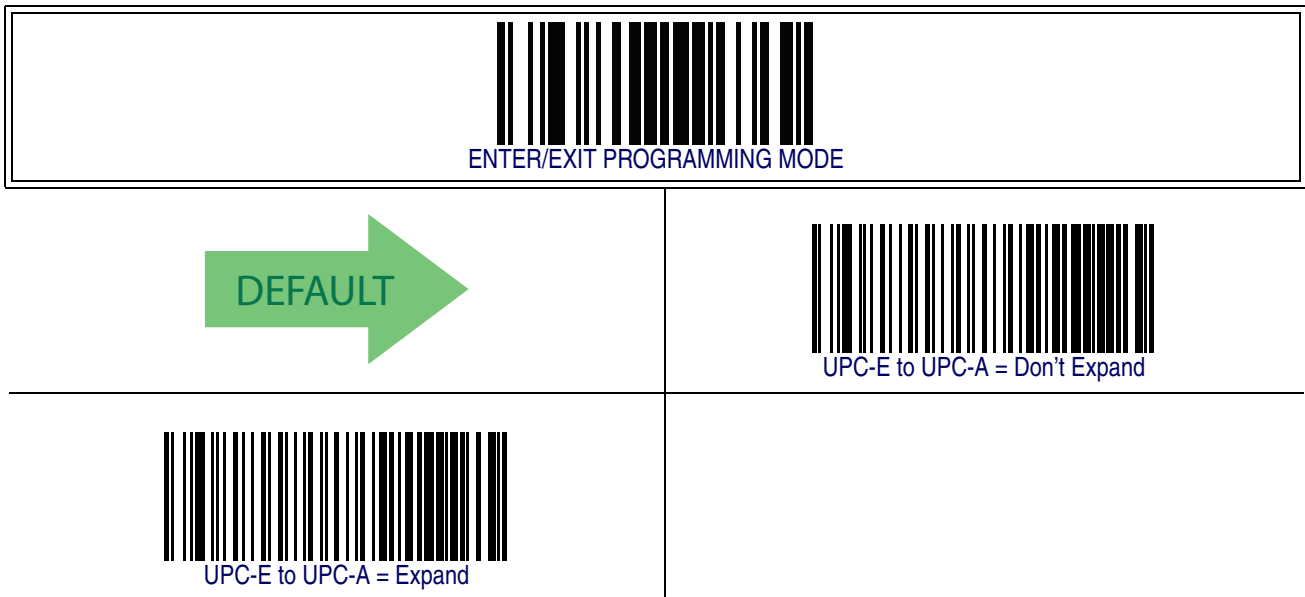

UPC-E – cont.

UPC-E Number System Character Transmission

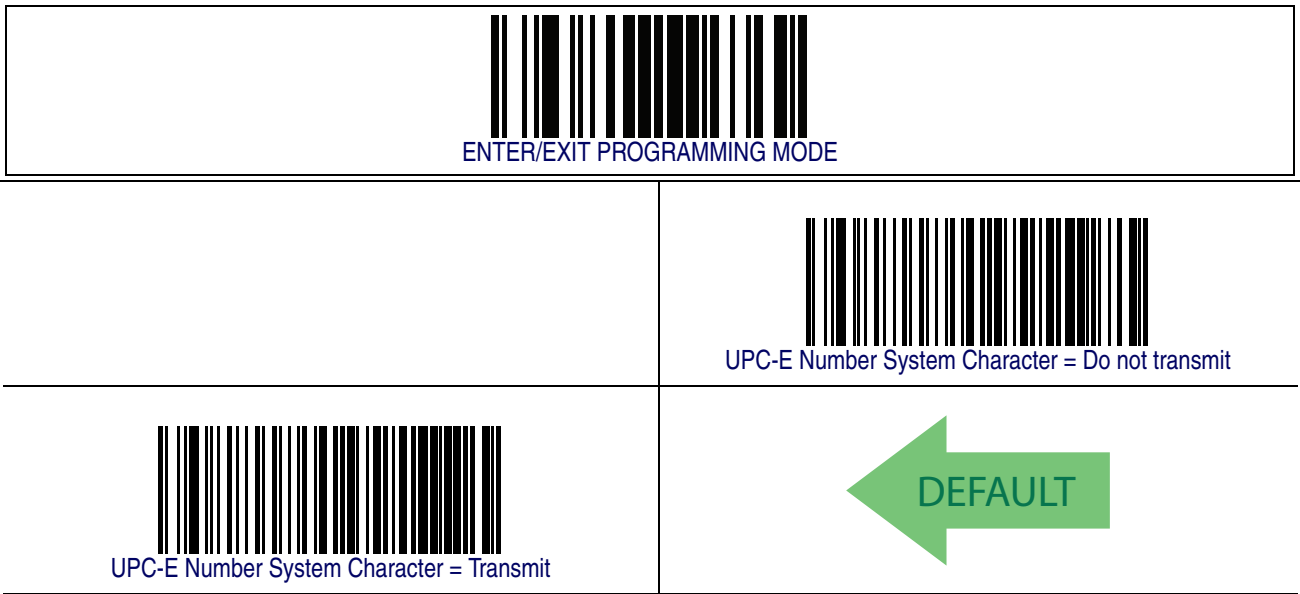

This feature enables/disables transmission of the UPC-E system number character.



UPC-E — cont.

UPC-E Minimum Reads

This feature specifies the minimum number of consecutive times a UPC-E label must be decoded before it is accepted as good read..

| | |
|--|---|
|  ENTER/EXIT PROGRAMMING MODE | |
| |  UPC-E Minimum Reads = 1 |
|  UPC-E Minimum Reads = 2 |  DEFAULT |
| |  UPC-E Minimum Reads = 3 |
|  UPC-E Minimum Reads = 4 | |

GTIN Formatting

This feature enables/disables the ability to convert UPC-E, UPC-A, EAN 8, and EAN 13 labels into the GTIN 14-character format.



NOTE

If add-on information is present on the base label prior to the conversion taking place, the add-on information will be appended to the converted GTIN label.

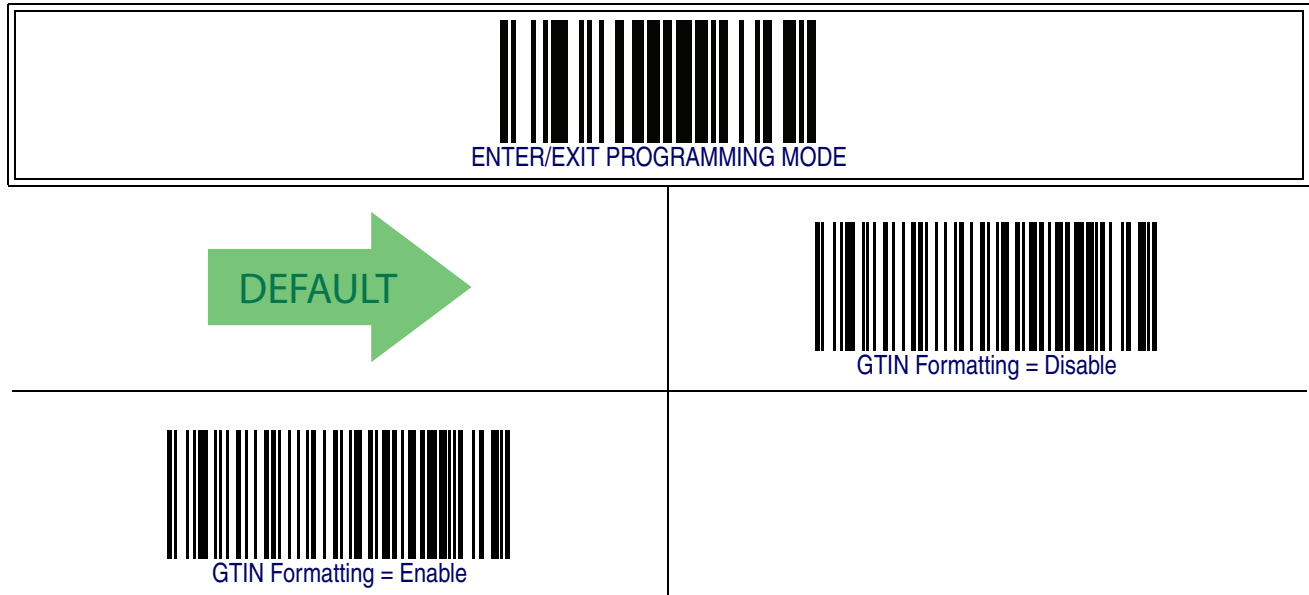

EAN 13

The following options apply to the EAN 13 (Jan 13) symbology.

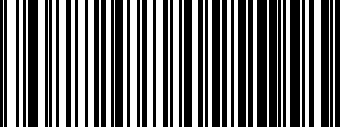
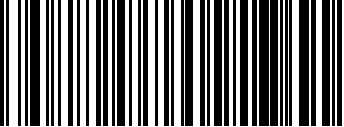

EAN 13 Enable/Disable

When disabled, the reader will not read EAN 13/JAN 13 barcodes.

| | |
|--|--|
|  ENTER/EXIT PROGRAMMING MODE | |
| |  EAN 13 = Disable |
|  EAN 13 = Enable |  DEFAULT |

EAN 13 Check Character Transmission

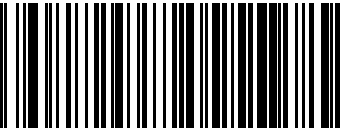
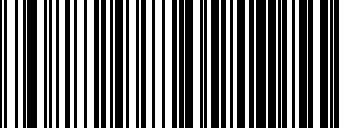

Enable this option to transmit the check character along with EAN 13 barcode data.

| | |
|---|--|
|  ENTER/EXIT PROGRAMMING MODE | |
| |  EAN 13 Check Character Transmission = Don't Send |
|  EAN 13 Check Character Transmission = Send |  DEFAULT |

EAN 13 — cont.

EAN-13 Flag 1 Character

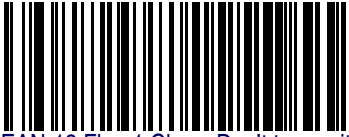
Enables/disables transmission of an EAN/JAN13 Flag1 character. The Flag 1 character is the first character of the label.

| | |
|---|--|
|  ENTER/EXIT PROGRAMMING MODE | |
| |  EAN-13 Flag 1 Char= Don't transmit |
|  EAN-13 Flag 1 Char= Transmit |  DEFAULT |

EAN-13 ISBN Conversion

This option enables/disables conversion of EAN 13/JAN 13 Bookland labels starting with 978 to ISBN labels.

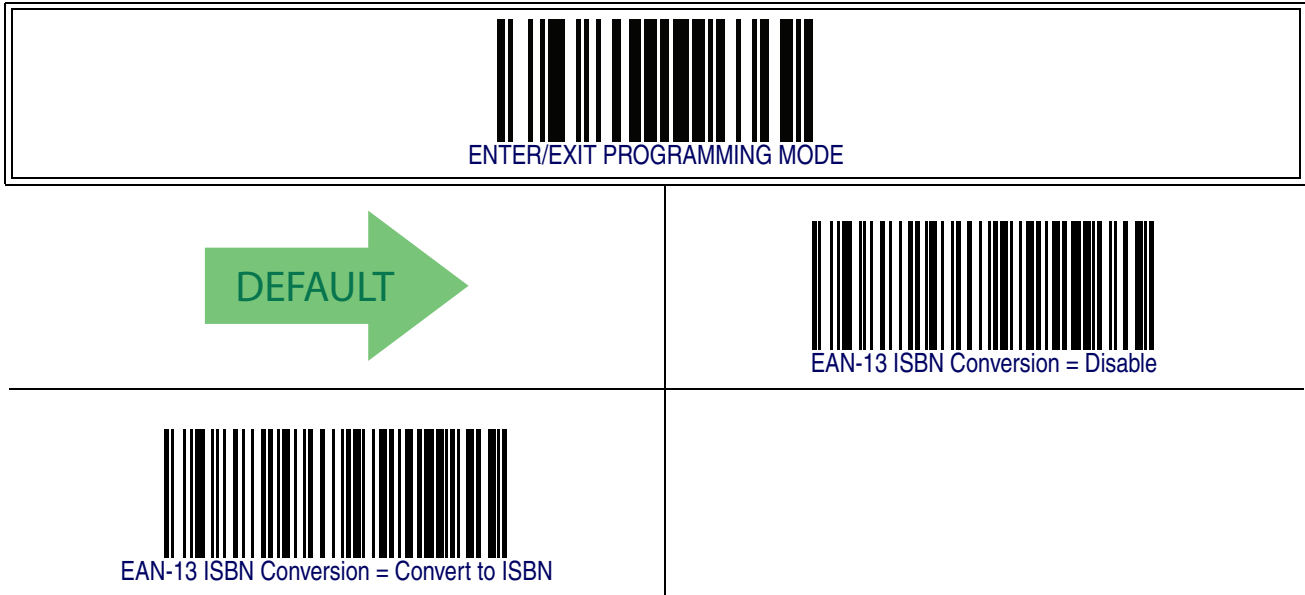

ISSN Enable/Disable

Enables/disables conversion of EAN/JAN13 Bookland labels starting with 977 to ISSN labels.



EAN 13 – cont.

EAN 13 Minimum Reads

This feature specifies the minimum number of consecutive times an EAN 13 label must be decoded before it is accepted as good read..





EAN 8

The following options apply to the EAN 8 (Jan 8) symbology.

EAN 8 Enable/Disable

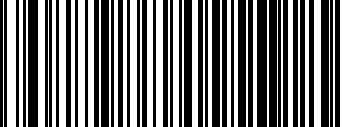
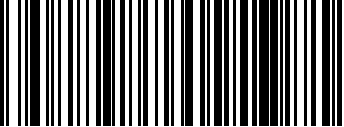
When disabled, the reader will not read EAN 8/JAN 8 barcodes.

| | |
|--|---|
|  ENTER/EXIT PROGRAMMING MODE | |
| |  EAN 8 = Disable |
|  EAN 8 = Enable |  DEFAULT |

EAN 8 Check Character Transmission

Enable this option to transmit the check character along with EAN 8 barcode data.

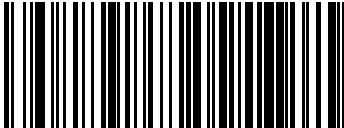
| | |
|--|---|
|  ENTER/EXIT PROGRAMMING MODE | |
| |  EAN 8 Check Character Transmission = Don't Send |
|  EAN 8 Check Character Transmission = Send |  DEFAULT |

EAN 8 – cont.

Expand EAN 8 to EAN 13

Enable this option to expand EAN 8/JAN 8 labels to EAN 13/JAN 13.



EAN 8 – cont.

EAN 8 Minimum Reads

This feature specifies the minimum number of consecutive times an EAN 8 (Jan 8) label must be decoded before it is accepted as good read..



UPC/EAN Global Settings

This section provides configuration settings for UPC-A, UPC-E, EAN 13 and EAN 8 symbologies, and affects all of these unless otherwise marked for each feature description.

UPC/EAN Decoding Level



Decoding Levels are used to configure a barcode symbology decoder to be very aggressive to very conservative depending on a particular customer's needs.

- Choosing Level 1 results in a very conservative decoder at the expense of not being able to read poorly printed or damaged labels.
- Choosing Level 5 results in a very aggressive decoder. This aggressive behavior allows decoding of poorly printed and damaged labels at the expense of increasing the likelihood of decoding errors.
- Choosing Level 3, which is the default setting, allows the majority of product labels to be decoded.

There are many factors that determine when to change the decoding level for a particular symbology. These factors include spots, voids, non-uniform bar/space widths, damaged labels, etc. that may be experienced in some barcode labels. If there are many hard to read or damaged labels that cannot be decoded using a conservative setting, increase the decoding level to be more aggressive. If the majority of labels are very good quality labels, or there is a need to decrease the possibility of a decoder error, lower the decoding level to a more conservative level.

UPC/EAN Global Settings – cont.

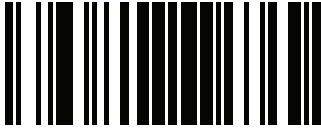
UPC/EAN Decoding Level – cont.

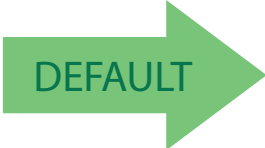
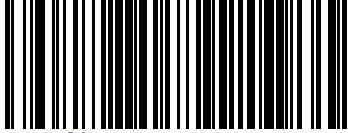
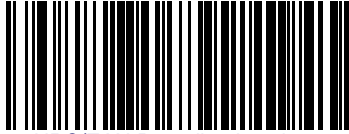
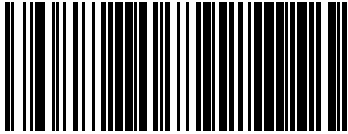
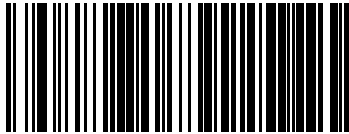
| | |
|---|--|
|  ENTER/EXIT PROGRAMMING MODE | |
|  UPC/EAN Decoding Level = 1 | |
|  DEFAULT |  UPC/EAN Decoding Level = 2 |
|  UPC/EAN Decoding Level = 3 | |
| |  UPC/EAN Decoding Level = 4 |
|  UPC/EAN Decoding Level = 5 | |

UPC/EAN Global Settings – cont.

UPC/EAN Correlation

When correlation is enabled, the barcode reader will combine label data from multiple scans when decoding. Enabling correlation will help the scanner read labels that have some spots and/or voids. It may also help read labels that have damaged areas. Enabling correlation will also increase the chances that a label will be read incorrectly.



UPC/EAN Reconstruction

This option enables/disables character reconstruction for UPC/EAN labels.

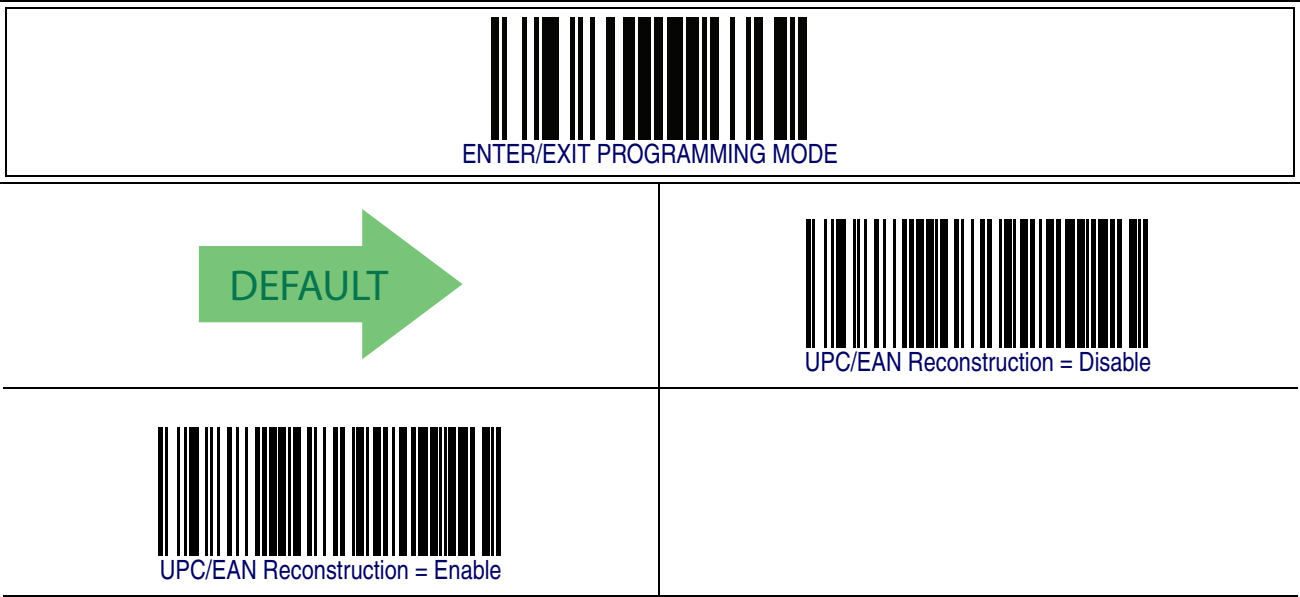

UPC/EAN Global Settings – cont.

UPC/EAN Price Weight Check

This feature enables/disables calculation and verification of price/weight check digits.
Options are

- Disabled
- Enable 4-digit price-weight check-digit calculation
- Enable 5-digit price-weight check-digit calculation
- Enable European 4-digit price-weight check-digit calculation
- Enable European 5-digit price-weight check-digit calculation

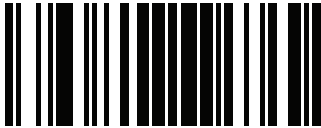
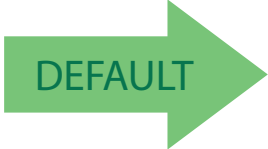
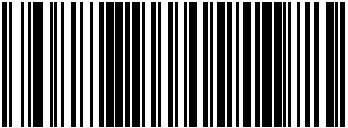
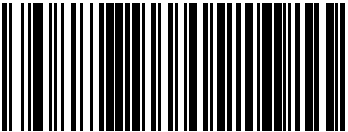
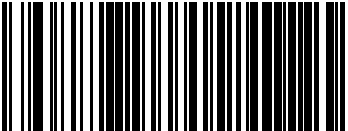
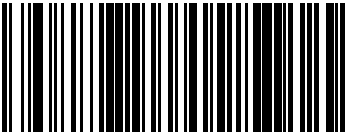
| | |
|---|--|
|  ENTER/EXIT PROGRAMMING MODE | |
|  |  Price Weight Check = Disabled |
|  Price Weight Check = 4-digit price-weight check | |
| |  Price Weight Check = 5-digit price-weight check |
|  Price Weight Check = European 4-digit price-weight check | |
| |  Price Weight Check = European 5-digit price-weight check |

UPC/EAN Global Settings – cont.

UPC-A Minimum Reads

This feature specifies the minimum number of consecutive times a UPC-A label must be decoded before it is accepted as good read..



Add-Ons

The following features apply to optional add-ons.



NOTE

Contact Customer Support for advanced programming of optional and conditional add-ons.

Optional Add-ons

The reader can be enabled to optionally read the following add-ons (supplementals):

- P2
- P5
- GS1-128



NOTE

If a UPC/EAN base label and a an add-on are both decoded, the reader will transmit the base label and add-on. If a UPC/EAN base label is decoded without an add-on, the base label will be transmitted without an add-on.

Conditional add-on settings (if enabled) are considered by the reader before optional add-on settings.



Add-Ons – cont.

Optional Add-ons – cont.

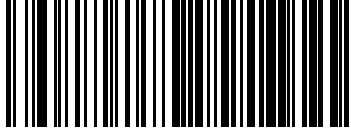
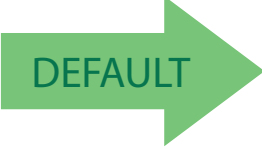
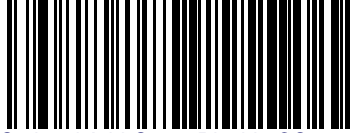
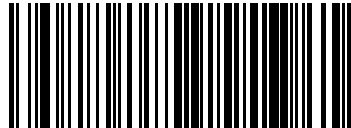
| | |
|---|--|
|  ENTER/EXIT PROGRAMMING MODE | |
|  Optional Add-Ons = Enable P5 | |
|  DEFAULT |  Optional Add-Ons = Disable GS1-128 |
|  Optional Add-Ons = Enable GS1-128 | |

Add-Ons — cont.

Optional Add-On Timer

This option sets the time the reader will look for an add-on when an add-on fragment has been seen and optional add-ons are enabled. (Also see [Optional GS1-128 Add-On Timer on page 155.](#))

| | |
|---|--|
|  ENTER/EXIT PROGRAMMING MODE | |
|  Optional Add-on Timer = 10ms | |
| |  Optional Add-on Timer = 20ms |
|  Optional Add-on Timer = 30ms | |
| |  Optional Add-on Timer = 40ms |
|  Optional Add-on Timer = 50ms | |

Add-Ons – cont.

Optional Add-On Timer – cont.

| | |
|--|---|
|  ENTER/EXIT PROGRAMMING MODE | |
| |  Optional Add-on Timer = 60ms |
|  Optional Add-on Timer = 70ms |  |
| |  Optional Add-on Timer = 100ms |
|  Optional Add-on Timer = 120ms | |
| |  Optional Add-on Timer = 140ms |
|  Optional Add-on Timer = 160ms | |

Add-Ons — cont.

Optional Add-On Timer — cont.

| | |
|--|---|
|  ENTER/EXIT PROGRAMMING MODE | |
| |  Optional Add-on Timer = 180ms |
|  Optional Add-on Timer = 200ms | |
| |  Optional Add-on Timer = 220ms |
|  Optional Add-on Timer = 240ms | |
| |  Optional Add-on Timer = 260ms |
|  Optional Add-on Timer = 280ms | |
| |  Optional Add-on Timer = 300ms |

Add-Ons – cont.

Optional GS1-128 Add-On Timer

This option sets the timer expiration value to read the added part after reading the linear EAN/UPC part. For UPC/EAN add-ons other than those of that type, see [Optional Add-On Timer on page 152](#).

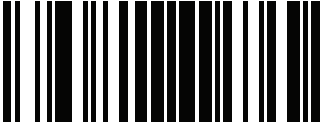
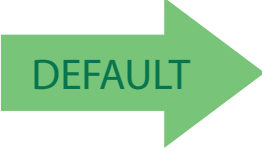
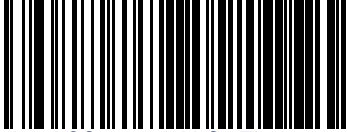
| | |
|---|---|
|  ENTER/EXIT PROGRAMMING MODE | |
|  DEFAULT |  Optional GS1-128 Add-On Timer = Disable |
|  Optional GS1-128 Add-On Timer = 10ms | |
| |  Optional GS1-128 Add-On Timer = 20ms |
|  Optional GS1-128 Add-On Timer = 30ms | |
| |  Optional GS1-128 Add-On Timer = 40ms |
|  Optional GS1-128 Add-On Timer = 50ms | |





Add-Ons — cont.

Optional GS1-128 Add-On Timer — cont.

| | |
|--|---|
|  ENTER/EXIT PROGRAMMING MODE | |
| |  Optional GS1-128 Add-On Timer = 60ms |
|  Optional GS1-128 Add-On Timer = 70ms | |
| |  Optional GS1-128 Add-On Timer = 100ms |
|  Optional GS1-128 Add-On Timer = 120ms | |
| |  Optional GS1-128 Add-On Timer = 140ms |
|  Optional GS1-128 Add-On Timer = 160ms | |

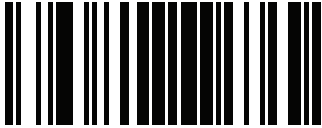
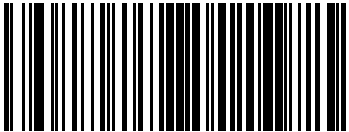
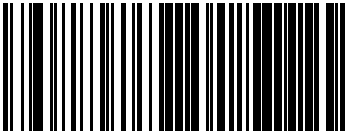
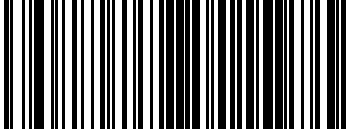
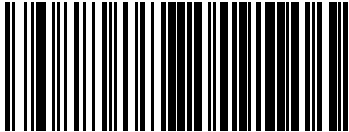
Add-Ons – cont.

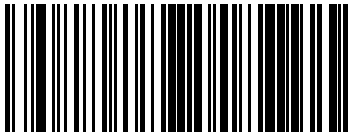
Optional GS1-128 Add-On Timer – cont.

| | |
|--|---|
|  ENTER/EXIT PROGRAMMING MODE | |
| |  Optional GS1-128 Add-On Timer = 180ms |
|  Optional GS1-128 Add-On Timer = 200ms | |
| |  Optional GS1-128 Add-On Timer = 220ms |
|  Optional GS1-128 Add-On Timer = 240ms | |
| |  Optional GS1-128 Add-On Timer = 260ms |
|  Optional GS1-128 Add-On Timer = 280ms | |
| |  Optional GS1-128 Add-On Timer = 300ms |

Add-Ons — cont.

P2 Add-Ons Minimum Reads

This feature specifies the minimum number of times a P2 add-on must be read before it is marked as valid and then combined with a base label.

| | |
|---|---|
|  ENTER/EXIT PROGRAMMING MODE | |
| |  P2 Add-Ons Minimum Reads = 1 |
|  P2 Add-Ons Minimum Reads = 2 |  DEFAULT |
| |  P2 Add-Ons Minimum Reads = 3 |
|  P2 Add-Ons Minimum Reads = 4 | |

Add-Ons — cont.

P5 Add-Ons Minimum Reads

This feature specifies the minimum number of times a P5 add-on must be read before it is marked as valid and then combined with a base label.

| | |
|---|--|
|  ENTER/EXIT PROGRAMMING MODE | |
|  DEFAULT |  P5 Add-Ons Minimum Reads = 1 |
|  P5 Add-Ons Minimum Reads = 2 | |
| |  P5 Add-Ons Minimum Reads = 3 |
|  P5 Add-Ons Minimum Reads = 4 | |

Add-Ons — cont.

GS1-128 Add-Ons Minimum Reads

This feature specifies the minimum number of times an GS1-128 add-on must be read before it is marked as valid and then combined with a base label.



GS1 DataBar™ Omnidirectional

The following options apply to the GS1 DataBar Omnidirectional (formerly RSS-14) symbology.

GS1 DataBar Omnidirectional Enable/Disable

When disabled, the reader will not read GS1 DataBar Omnidirectional barcodes.



GS1 DataBar Omnidirectional GS1-128 Emulation

When enabled, GS1 DataBar Omnidirectional barcodes will be translated to the GS1-128 label data format.



GS1 DataBar™ Omnidirectional – cont.

GS1 DataBar Omnidirectional Minimum Reads

This feature specifies the minimum number of consecutive times a GS1 DataBar Omnidirectional label must be decoded before it is accepted as good read.



GS1 DataBar™ Expanded

The following options apply to the GS1 DataBar Expanded (formerly RSS Expanded) symbology.

GS1 DataBar Expanded Enable/Disable

When disabled, the reader will not read GS1 DataBar Expanded barcodes.



GS1 DataBar Expanded GS1-128 Emulation

When enabled, GS1 DataBar Expanded barcodes will be translated to the GS1-128 label data format.

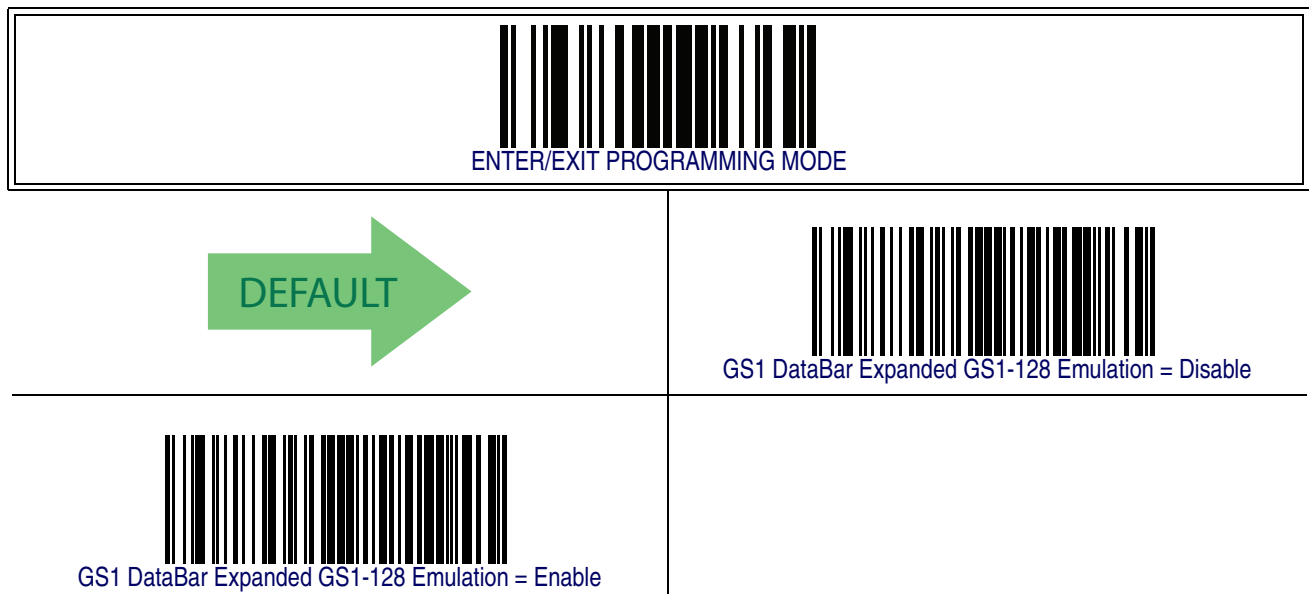

GS1 DataBar™ Expanded — cont.

GS1 DataBar Expanded Minimum Reads

This feature specifies the minimum number of consecutive times a GS1 DataBar Expanded label must be decoded before it is accepted as good read.



GS1 DataBar™ Expanded – cont.

GS1 DataBar Expanded Length Control

This feature specifies either variable length decoding or fixed length decoding for the GS1 DataBar Expanded symbology.

Variable Length – For variable-length decoding, a minimum length may be set.

Fixed Length – For fixed-length decoding, two different lengths may be set.

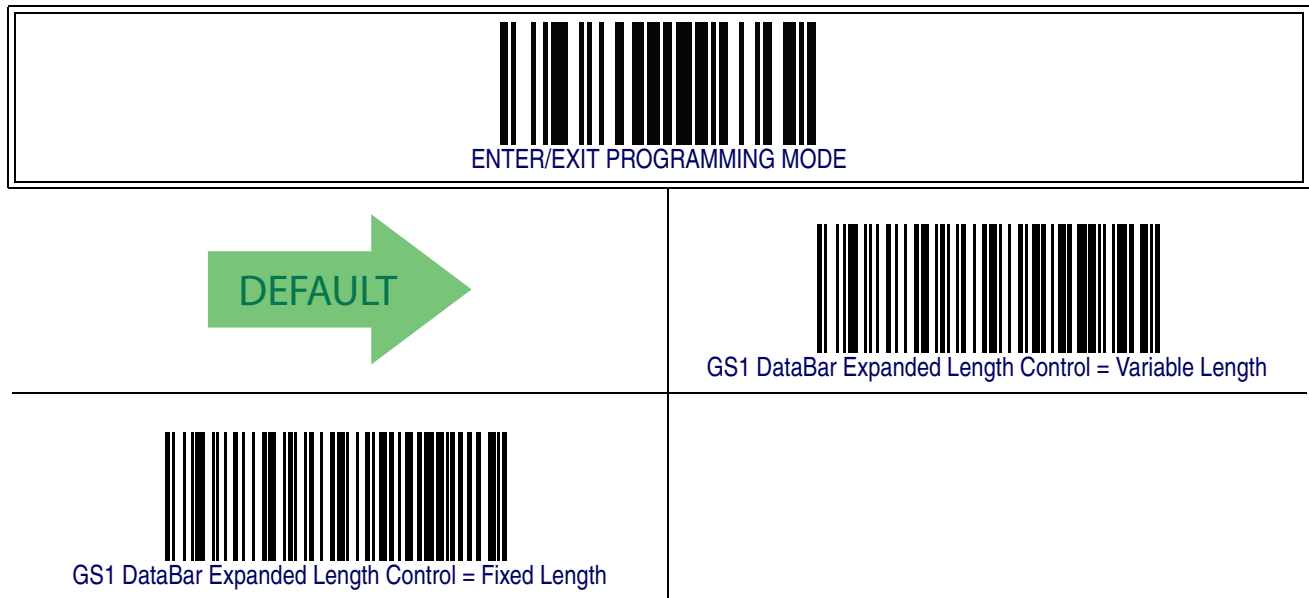

GS1 DataBar™ Expanded – cont.

GS1 DataBar Expanded Set Length 1

This feature specifies one of the barcode lengths for [GS1 DataBar Expanded Length Control](#). Length 1 is the minimum label length if in [Variable Length Mode](#), or the first fixed length if in [Fixed Length Mode](#). Length includes the barcode’s data characters only.

The length can be set from 1 to 74 characters.

Follow these instructions to set this feature:

1. Determine the desired character length (from 1 to 74). Pad the number with leading zeroes to yield two digits. For example: 0 = 00, 5 = 05, 20 = 20, etc.
2. Scan the ENTER/EXIT PROGRAMMING MODE barcode to enter Programming Mode.
3. Scan the barcode: SELECT GS1 DATABAR EXPANDED LENGTH 1 SETTING.
4. Scan the appropriate two digits from the keypad in [Appendix E, Keypad](#), that represent the length setting which was determined in the steps above. You will hear a two-beep indication after the last character.



If you make a mistake before the last character, scan the CANCEL barcode to abort and not save the entry string. You can then start again at the beginning.

NOTE

5. Scan the ENTER/EXIT PROGRAMMING MODE barcode to exit Programming Mode.

This completes the procedure. See [Table 19](#) for some examples of how to set this feature.

Table 19. GS1 DataBar Expanded Length 1 Setting Examples

| STEP | ACTION | EXAMPLES | | | |
|------|---|--------------|---------------|---------------|---------------|
| 1 | Desired Setting | 01 Character | 07 Characters | 52 Characters | 74 Characters |
| 2 | Scan ENTER/EXIT PROGRAMMING MODE | | | | |
| 3 | Scan SELECT GS1 DATABAR EXPANDED LENGTH 1 SETTING | | | | |
| 4 | Scan Two Characters From Appendix E, Keypad | '0' and '1' | '0' and '7' | '5' and '2' | '7' AND '4' |
| 5 | Scan ENTER/EXIT PROGRAMMING MODE | | | | |

GS1 DataBar™ Expanded – cont.

GS1 DataBar Expanded Set Length 1 – cont.

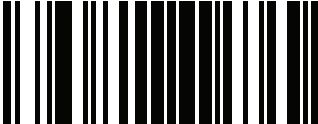
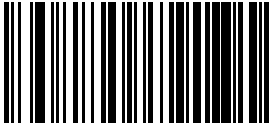
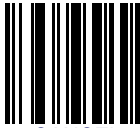
| | |
|---|---|
|  ENTER/EXIT PROGRAMMING MODE | |
|  Select GS1 DataBar Expanded Set Length 1 Setting | |
| Make a mistake? Scan the CANCEL barcode to abort and not save the entry string. You can then start again at the beginning. |  CANCEL |

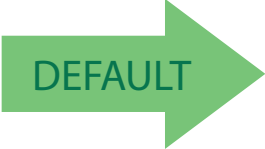
 01 = Length 1 is 1 Character

GS1 DataBar™ Expanded – cont.

GS1 DataBar Expanded Set Length 2

This feature specifies one of the barcode lengths for [GS1 DataBar Expanded Length Control](#). Length 2 is the maximum label length if in [Variable Length Mode](#), or the second fixed length if in [Fixed Length Mode](#). Length includes the barcode's data characters only.

The length can be set from 1 to 74 characters. A setting of 0 specifies to ignore this length (only one fixed length).

Follow these instructions to set this feature:

1. Determine the desired character length (from 1 to 74). Pad the number with leading zeroes to yield two digits. For example: 0 = 00, 5 = 05, 20 = 20, etc.
2. Scan the ENTER/EXIT PROGRAMMING MODE barcode to enter Programming Mode.
3. Scan the barcode: SELECT GS1 DATABAR EXPANDED LENGTH 2 SETTING.
4. Scan the appropriate two digits from the keypad in [Appendix E, Keypad](#), that represent the length setting which was determined in the steps above. You will hear a two-beep indication after the last character.



If you make a mistake before the last character, scan the CANCEL barcode to abort and not save the entry string. You can then start again at the beginning.

NOTE

5. Scan the ENTER/EXIT PROGRAMMING MODE barcode to exit Programming Mode.

This completes the procedure. See [Table 20](#) for some examples of how to set this feature.

Table 20. GS1 DataBar Expanded Length 2 Setting Examples

| STEP | ACTION | EXAMPLES | | | |
|------|---|---------------------------|---------------|---------------|---------------|
| 1 | Desired Setting | 00 (ignore second length) | 07 Characters | 52 Characters | 74 Characters |
| 2 | Scan ENTER/EXIT PROGRAMMING MODE | | | | |
| 3 | Scan SELECT GS1 DATABAR EXPANDED LENGTH 2 SETTING | | | | |
| 4 | Scan Two Characters From Appendix E, Keypad | '0' and '0' | '0' and '7' | '5' and '2' | '7' and '4' |
| 5 | Scan ENTER/EXIT PROGRAMMING MODE | | | | |

GS1 DataBar™ Expanded – cont.

GS1 DataBar Expanded Set Length 2 – cont.

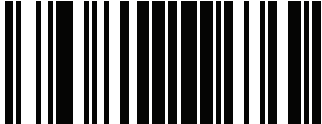
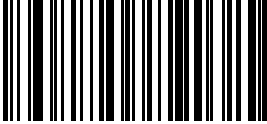
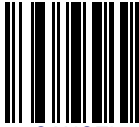
| | |
|---|---|
|  ENTER/EXIT PROGRAMMING MODE | |
|  Select GS1 DataBar Expanded Set Length 2 Setting | |
| Make a mistake? Scan the CANCEL barcode to abort and not save the entry string. You can then start again at the beginning. |  CANCEL |

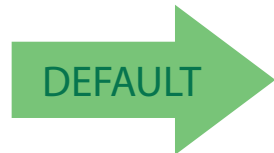

74 = Length 2 is 74 Characters

GS1 DataBar™ Limited

The following options apply to the GS1 DataBar Limited (formerly RSS Limited) symbology.

GS1 DataBar Limited Enable/Disable

When disabled, the reader will not read GS1 DataBar Limited barcodes.



GS1 DataBar Limited GS1-128 Emulation

When enabled, GS1 DataBar Limited barcodes will be translated to the GS1-128 label data format.



GS1 DataBar™ Limited – cont.

GS1 DataBar Limited Minimum Reads

This feature specifies the minimum number of consecutive times a GS1 DataBar Limited label must be decoded before it is accepted as good read.



Code 39

The following options apply to the Code 39 symbology.

Code 39 Enable/Disable

When disabled, the reader will not read Code 39 barcodes.

| | |
|--|---|
|  ENTER/EXIT PROGRAMMING MODE | |
| |  Code 39 = Disable |
|  Code 39 = Enable |  DEFAULT |

Code 39 — cont.

Code 39 Check Character Calculation

Enable this option to enables/disables calculation and verification of an optional Code 39 check character. When disabled, any check character in the label is treated as a data character

| | |
|--|--|
|  ENTER/EXIT PROGRAMMING MODE | |
| |  Code 39 Check Character Calculation = Don't Calculate |
|  Code 39 Check Character Calculation = Calculate Std Check |  |
| |  Code 39 Check Character Calculation = Calculate Mod 7 Check |
|  Code 39 Check Character Calculation = Enable Italian Post Check | |
| |  Code 39 Check Character Calculation = Enable Daimler Chrysler Check |

Code 39 – cont.

Code 39 Check Character Transmission

Enable this option to transmit the check character along with Code 39 barcode data.

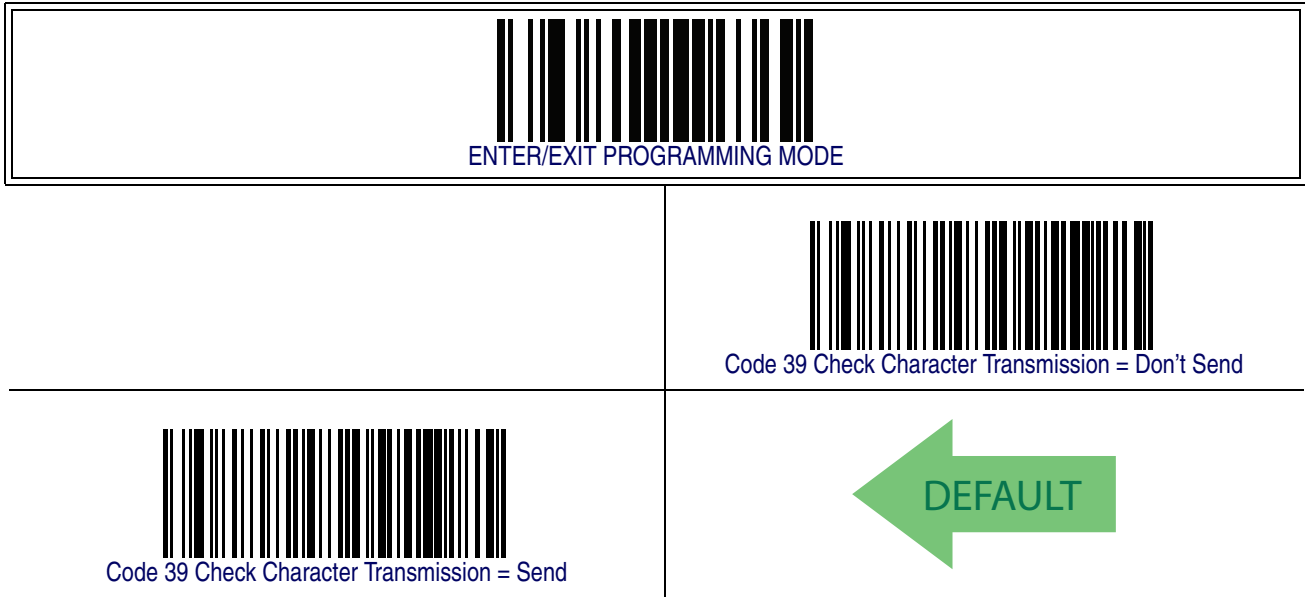

Code 39 Start/Stop Character Transmission

Enable this option to enable/disable transmission of Code 39 start and stop characters.

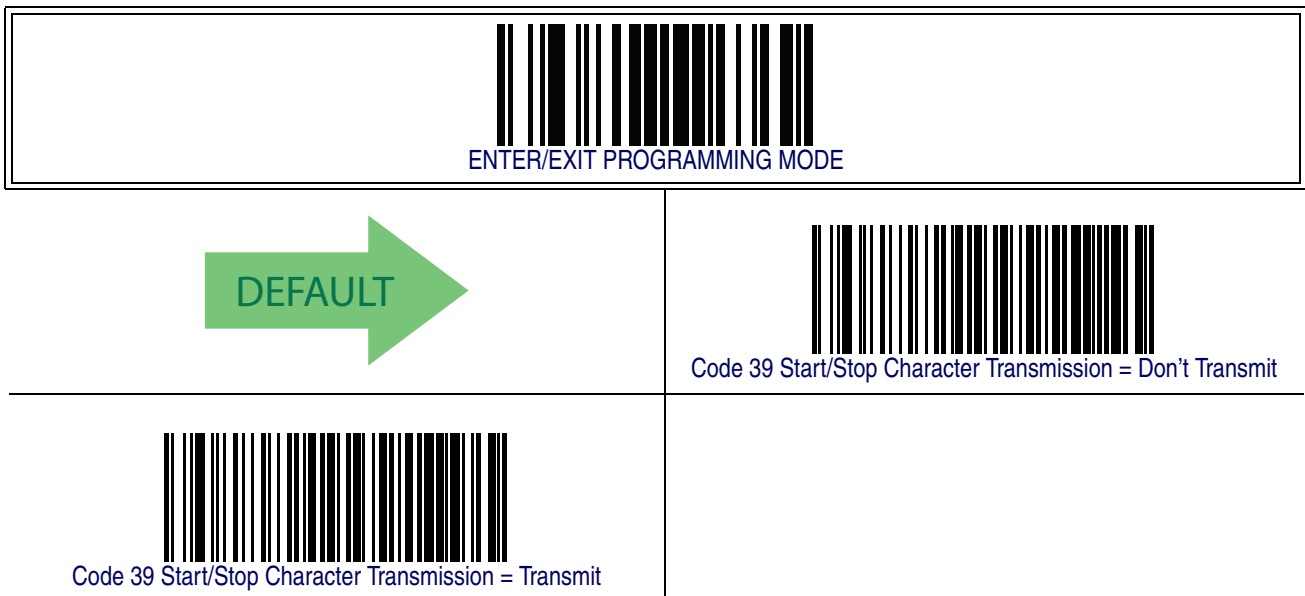

Code 39 — cont.

Code 39 Full ASCII

In Code 39 decoding, this enables/disables the translation of Code 39 characters to Code 39 full-ASCII characters.



Code 39 – cont.

Code 39 Quiet Zones

This feature specifies the number of quiet zones for Code 39 labels. Quiet zones are blank areas at the ends of a barcode and are typically 10 times the width of the narrowest bar or space in the label.

| | |
|---|--|
|  ENTER/EXIT PROGRAMMING MODE | |
|  Code 39 Quiet Zones = Quiet Zone on one side | |
| |  Code 39 Quiet Zones = Quiet Zones on two sides |
|  Code 39 Quiet Zones = Auto |  DEFAULT |
| |  Code 39 Quiet Zones = Virtual Quiet Zones on two sides |
|  Code 39 Quiet Zones = Small Quiet Zones on two sides | |

Code 39 — cont.

Code 39 Minimum Reads

This feature specifies the minimum number of consecutive times a Code 39 label must be decoded before it is accepted as good read..



Code 39 – cont.

Code 39 Decoding Level

Decoding Levels are used to configure a barcode symbology decoder to be very aggressive to very conservative depending on a particular customer's needs.

- Choosing Level 1 results in a very conservative decoder at the expense of not being able to read poorly printed or damaged labels.
- Choosing Level 5 results in a very aggressive decoder. This aggressive behavior allows decoding of poorly printed and damaged labels at the expense of increasing the likelihood of decoding errors.
- Choosing Level 3, which is the default setting, allows the majority of product labels to be decoded.

There are many factors that determine when to change the decoding level for a particular symbology. These factors include spots, voids, non-uniform bar/space widths, damaged labels, etc. that may be experienced in some barcode labels. If there are many hard to read or damaged labels that cannot be decoded using a conservative setting, increase the decoding level to be more aggressive. If the majority of labels are very good quality labels, or there is a need to decrease the possibility of a decoder error, lower the decoding level to a more conservative level.



This configuration item applies to Code 39 and Code 32.

NOTE

Code 39 — cont.

Code 39 Decoding Level — cont.

| | |
|---|--|
|  ENTER/EXIT PROGRAMMING MODE | |
|  Code 39 Decoding Level = 1 | |
| |  Code 39 Decoding Level = 2 |
|  Code 39 Decoding Level = 3 |  DEFAULT |
| |  Code 39 Decoding Level = 4 |
|  Code 39 Decoding Level = 5 | |

Code 39 – cont.

Code 39 Length Control

This feature specifies either variable length decoding or fixed length decoding for the Code 39 symbology.

Variable Length – For variable length decoding, a minimum and maximum length may be set.

Fixed Length – For fixed length decoding, two different lengths may be set.



Code 39 – cont.

Code 39 Set Length 1

This feature specifies one of the barcode lengths for [Code 39 Length Control](#). Length 1 is the minimum label length if in [Variable Length Mode](#), or the first fixed length if in [Fixed Length Mode](#). Length includes the barcode's data characters only.

The length can be set from 0 to 50 characters.

Follow these instructions to set this feature:

1. Determine the desired character length (from 0 to 50). Pad the number with leading zeroes to yield two digits. For example: 0 = 00, 5 = 05, 20 = 20, etc.
2. Scan the ENTER/EXIT PROGRAMMING MODE barcode to enter Programming Mode.
3. Scan the barcode: SELECT CODE 39 LENGTH 1 SETTING.
4. Scan the appropriate two digits from the keypad in [Appendix E, Keypad](#), that represent the length setting which was determined in the steps above. You will hear a two-beep indication after the last character.



If you make a mistake before the last character, scan the CANCEL barcode to abort and not save the entry string. You can then start again at the beginning.

NOTE

5. Scan the ENTER/EXIT PROGRAMMING MODE barcode to exit Programming Mode.

This completes the procedure. See [Table 21](#) for some examples of how to set this feature.

Table 21. Code 39 Length 1 Setting Examples

| STEP | ACTION | EXAMPLES | | | |
|------|---|---------------|---------------|---------------|---------------|
| 1 | Desired Setting | 00 Characters | 07 Characters | 15 Characters | 50 Characters |
| 2 | Scan ENTER/EXIT PROGRAMMING MODE | | | | |
| 3 | Scan SELECT CODE 39 LENGTH 1 SETTING | | | | |
| 4 | Scan Two Characters From Appendix E, Keypad | '0' and '0' | '0' and '7' | '1' and '5' | '5' AND '0' |
| 5 | Scan ENTER/EXIT PROGRAMMING MODE | | | | |

Code 39 – cont.

Code 39 Set Length 1 – cont.

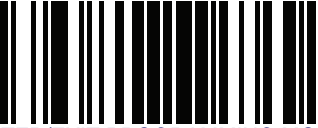
| |
|--|
|  ENTER/EXIT PROGRAMMING MODE |
|--|

| |
|--|
|  Select Code 39 Set Length 1 Setting |
|--|

Make a mistake? Scan the CANCEL barcode to abort and not save the entry string. You can then start again at the beginning.

| |
|---|
|  CANCEL |
|---|



Code 39 — cont.

Code 39 Set Length 2

This feature specifies one of the barcode lengths for [Code 39 Length Control](#). Length 2 is the maximum label length if in [Variable Length Mode](#), or the second fixed length if in [Fixed Length Mode](#). Length includes the barcode's check, data, and full-ASCII shift characters. The length does not include start/stop characters.

The length can be set from 1 to 50 characters. A setting of 0 specifies to ignore this length (only one fixed length).

Follow these instructions to set this feature:

1. Determine the desired character length (from 1 to 50 — or 0 to ignore this length). Pad the number with leading zeroes to yield two digits. For example: 0 = 00, 5 = 05, 20 = 20, etc.
2. Scan the ENTER/EXIT PROGRAMMING MODE barcode to enter Programming Mode.
3. Scan the barcode: SELECT CODE 39 LENGTH 2 SETTING.
4. Scan the appropriate two digits from the keypad in [Appendix E, Keypad](#), that represent the length setting which was determined in the steps above. You will hear a two-beep indication after the last character.



If you make a mistake, before the last character scan the CANCEL barcode to abort and not save the entry string. You can then start again at the beginning.

NOTE

5. Scan the ENTER/EXIT PROGRAMMING MODE barcode to exit Programming Mode.

This completes the procedure. See [Table 22](#) for some examples of how to set this feature.

Table 22. Code 39 Length 2 Setting Examples

| STEP | ACTION | EXAMPLES | | | |
|------|---|-------------------------|---------------|---------------|---------------|
| 1 | Desired Setting | 00 (Ignore This Length) | 07 Characters | 15 Characters | 50 Characters |
| 2 | Scan ENTER/EXIT PROGRAMMING MODE | | | | |
| 3 | Scan SELECT CODE 39 LENGTH 2 SETTING | | | | |
| 4 | Scan Two Characters From Appendix E, Keypad | '0' and '0' | '0' and '7' | '1' and '5' | '5' AND '0' |
| 5 | Scan ENTER/EXIT PROGRAMMING MODE | | | | |

Code 39 – cont.

Code 39 Set Length 2 – cont.

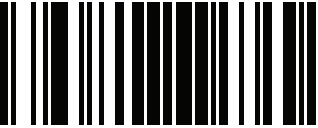
| |
|--|
|  ENTER/EXIT PROGRAMMING MODE |
|--|

| |
|--|
|  Select Code 39 Length 2 Setting |
|--|

Make a mistake? Scan the CANCEL barcode to abort and not save the entry string. You can then start again at the beginning.





| |
|---|
|  CANCEL |
|---|



Code 39 — cont.

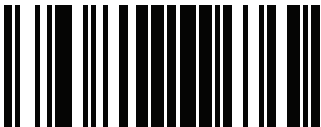
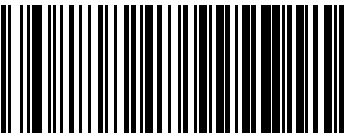

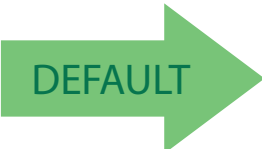
Code 39 Interdigit Ratio

This feature specifies the ratio between an intercharacter space and module for Code 39 labels.

| | |
|---|--|
|  ENTER/EXIT PROGRAMMING MODE | |
| |  Code 39 Interdigit Ratio = Disable |
|  Code 39 Interdigit Ratio = 1 | |
| |  Code 39 Interdigit Ratio = 2 |
|  Code 39 Interdigit Ratio = 3 | |
|  DEFAULT |  Code 39 Interdigit Ratio = 4 |
|  Code 39 Interdigit Ratio = 5 | |

Code 39 – cont.

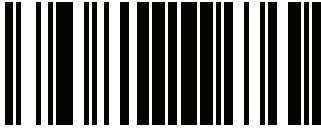
Code 39 Interdigit Ratio – cont.

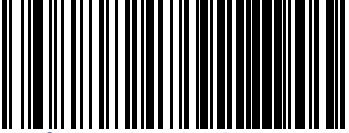
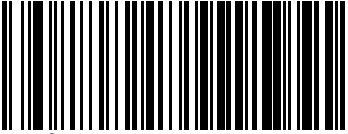
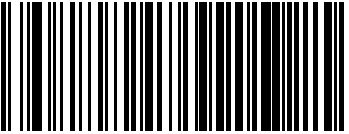
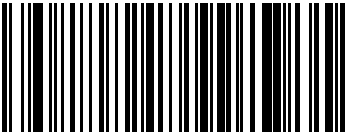
| | |
|---|---|
|  ENTER/EXIT PROGRAMMING MODE | |
| |  Code 39 Interdigit Ratio = 6 |
|  Code 39 Interdigit Ratio = 7 | |
| |  Code 39 Interdigit Ratio = 8 |
|  Code 39 Interdigit Ratio = 9 | |
| |  Code 39 Interdigit Ratio = 10 |

Code 39 — cont.

Code 39 Character Correlation

When correlation is enabled, the barcode reader will combine label data from multiple scans when decoding. Enabling correlation will help the scanner read labels that have some spots and/or voids. It may also help read labels that have damaged areas. Enabling correlation will also increase the chances that a label will be read incorrectly.

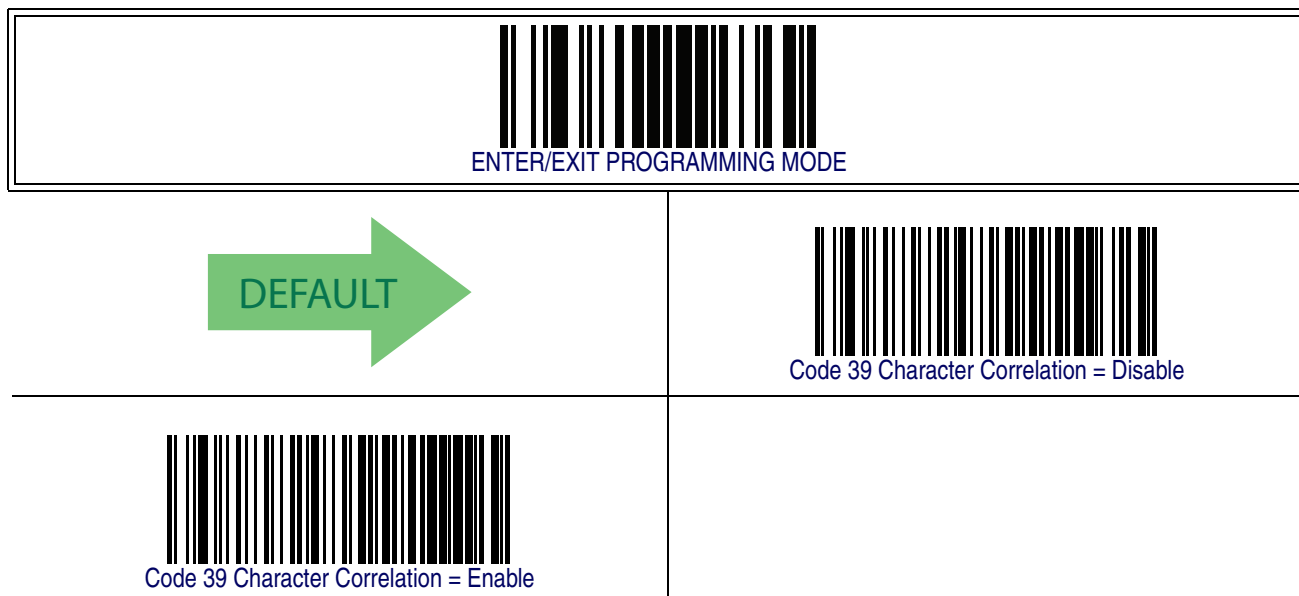

Code 39 Stitching

This option enables/disables stitching for Code 39 labels. When parts of a Code 39 barcode are presented to the reader with this feature enabled, the barcode parts will be assembled by the reader's software, and the data will be decoded if all barcode proofing requirements are met.



Code 32 (Italian Pharmaceutical)

The following options apply to the Code 32 (Italian Pharmaceutical Code) symbology.

Code 32 Enable/Disable

When disabled, the reader will not read Code 32 barcodes.

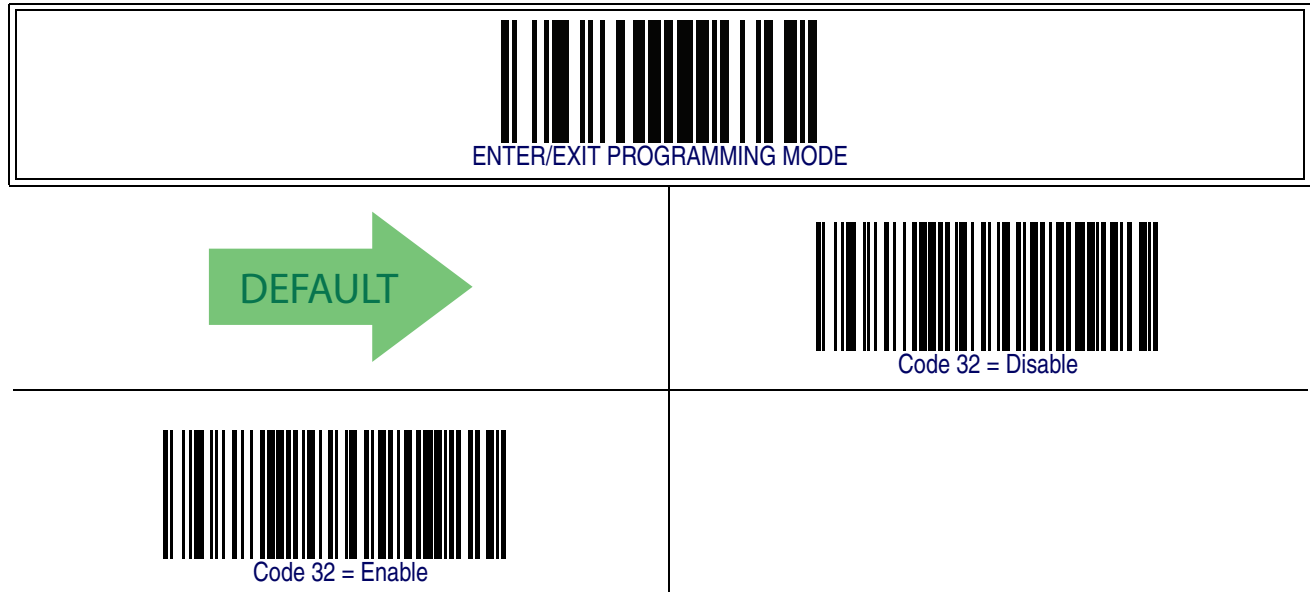

Code 32 Feature Setting Exceptions



NOTE

The following features are set for Code 32 by using these Code 39 settings:

- Code 39 Quiet Zones on page 176
- Code 39 Minimum Reads on page 177
- Code 39 Decoding Level on page 178
- Code 39 Interdigit Ratio on page 185
- Code 39 Character Correlation on page 187
- Code 39 Stitching on page 188

Code 32 (Italian Pharmaceutical) – cont.

Code 32 Check Character Transmission

Enable this option to transmit the check character along with Code 32 barcode data.

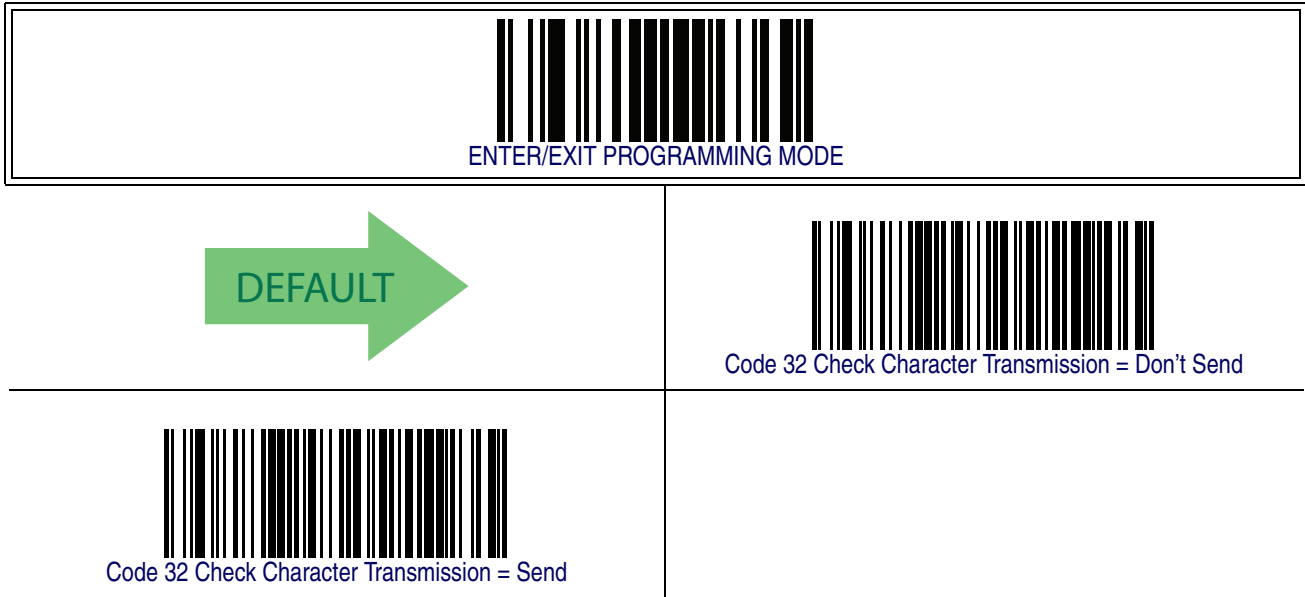

Code 32 Start/Stop Character Transmission

This option enables/disables transmission of Code 32 start and stop characters.

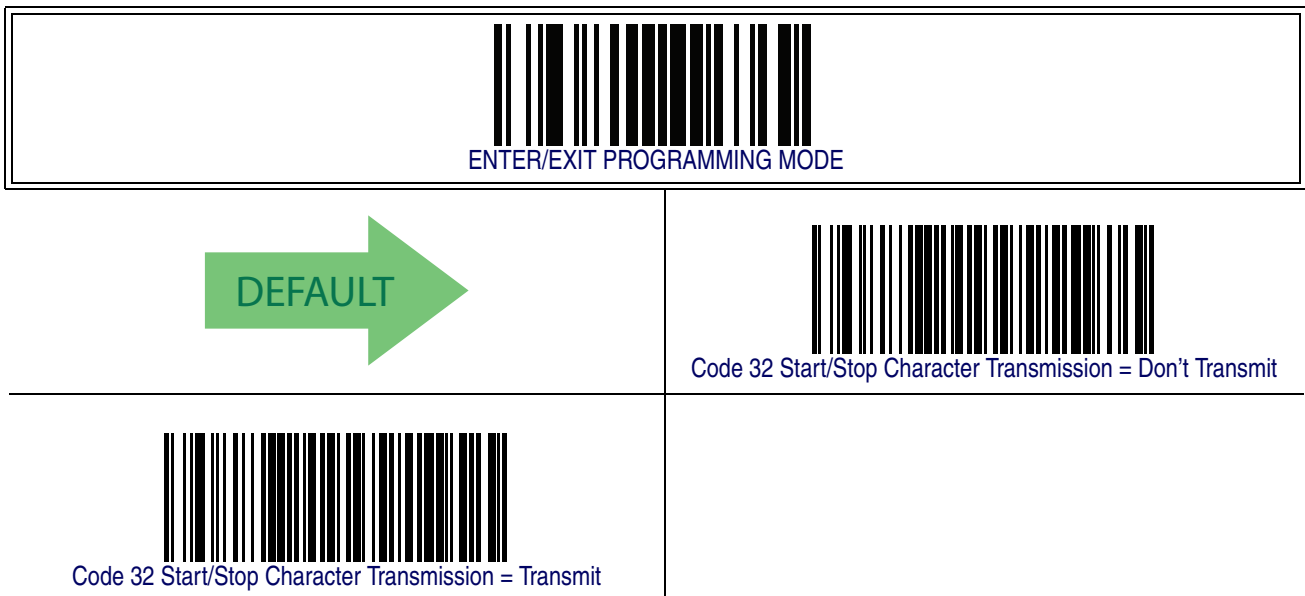

Code 39 CIP (French Pharmaceutical)

The following options apply to the Code 39 CIP symbology.

Code 39 CIP Enable/Disable

Enables/Disables ability of the reader to decode Code 39 CIP labels.

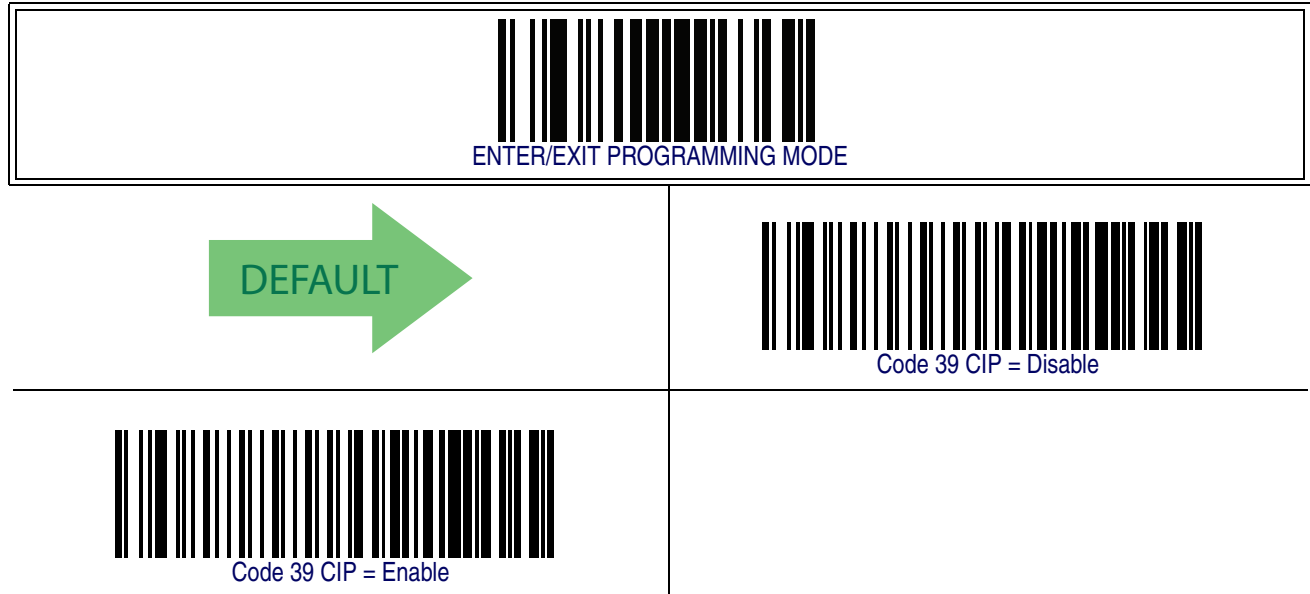

Code 128

The following options apply to the Code 128 symbology.

Code 128 Enable/Disable

When disabled, the reader will not read Code 128 barcodes.



Code 128 – cont.

Expand Code 128 to Code 39

This feature enables/disables expansion of Code 128 labels to Code 39 labels.

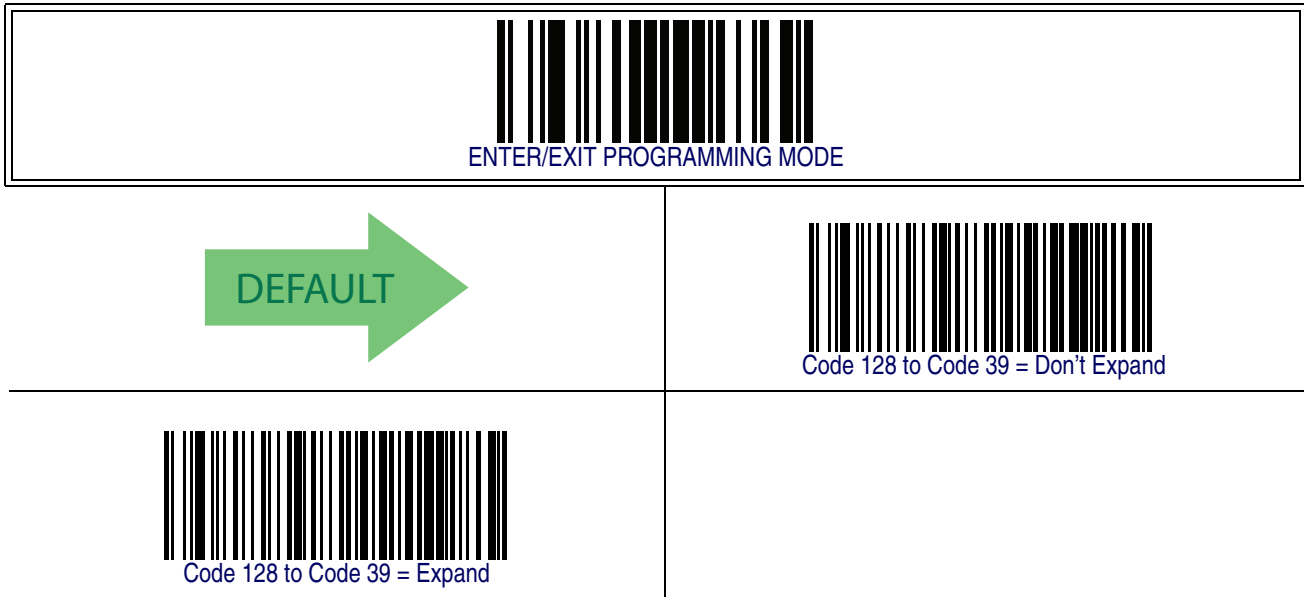

Code 128 Check Character Transmission

Enable this option to transmit the check character along with Code 128 barcode data.

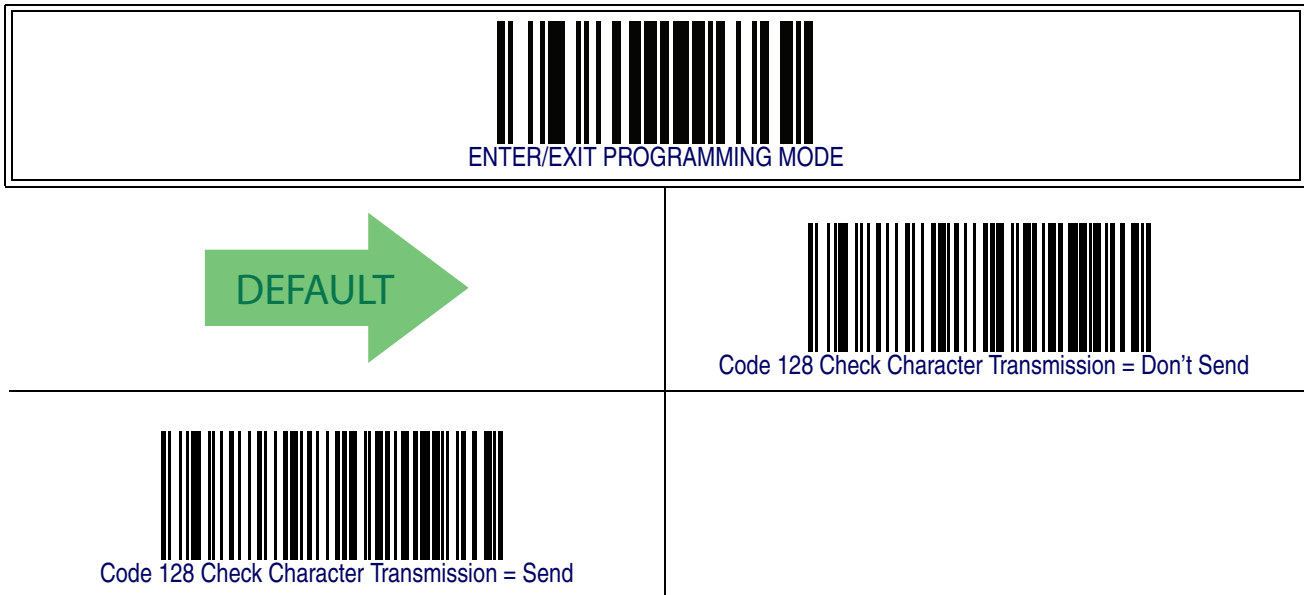

Code 128 – cont.

Code 128 Function Character Transmission

Enables/disables transmission of Code128 function characters 1, 2, 3, and 4.

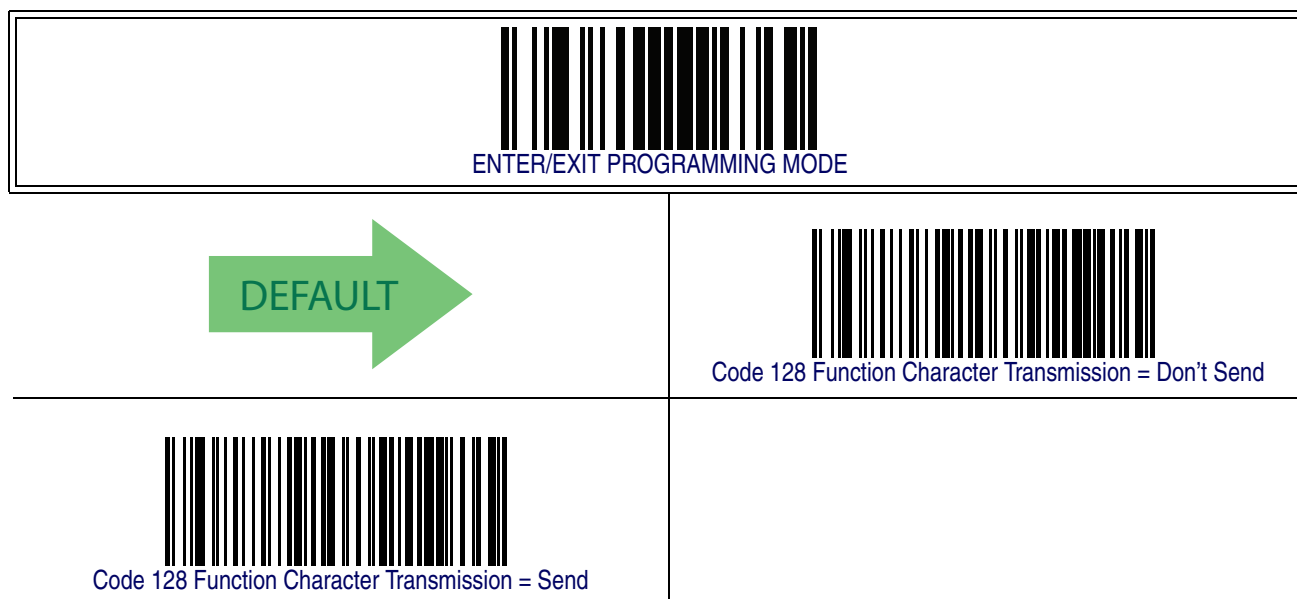

Code 128 – cont.

Code 128 Sub-Code Change Transmission

Enables/disables the transmission of “Sub-Code exchange” characters (NOT transmitted by standard decoding).

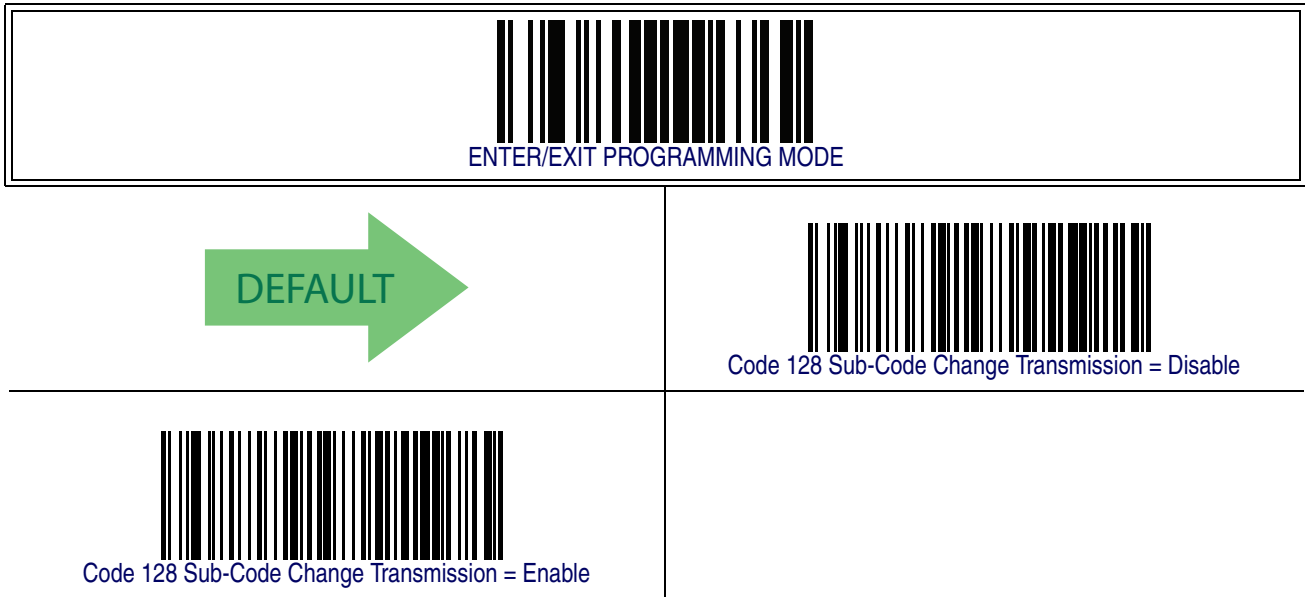

Code 128 – cont.

Code 128 Quiet Zones

This feature specifies the number of quiet zones for Code 128 labels. Quiet zones are blank areas at the ends of a barcode and are typically 10 times the width of the narrowest bar or space in the label.

| | |
|--|---|
|  ENTER/EXIT PROGRAMMING MODE | |
| |  Code 128 Quiet Zones = No Quiet Zones |
|  Code 128 Quiet Zones = Quiet Zone on one side | |
| |  Code 128 Quiet Zones = Quiet Zones on two sides |
|  Code 128 Quiet Zones = Auto |  |
| |  Code 128 Quiet Zones = Virtual Quiet Zones on two sides |

Code 128 – cont.

Code 128 Minimum Reads

This feature specifies the minimum number of consecutive times a Code 128 label must be decoded before it is accepted as good read..



Code 128 – cont.

Code 128 Decoding Level





Decoding Levels are used to configure a barcode symbology decoder to be very aggressive to very conservative depending on a particular customer's needs.

- Choosing Level 1 results in a very conservative decoder at the expense of not being able to read poorly printed or damaged labels.
- Choosing Level 5 results in a very aggressive decoder. This aggressive behavior allows decoding of poorly printed and damaged labels at the expense of increasing the likelihood of decoding errors.
- Choosing Level 3, which is the default setting, allows the majority of product labels to be decoded.

There are many factors that determine when to change the decoding level for a particular symbology. These factors include spots, voids, non-uniform bar/space widths, damaged labels, etc. that may be experienced in some barcode labels. If there are many hard to read or damaged labels that cannot be decoded using a conservative setting, increase the decoding level to be more aggressive. If the majority of labels are very good quality labels, or there is a need to decrease the possibility of a decoder error, lower the decoding level to a more conservative level.

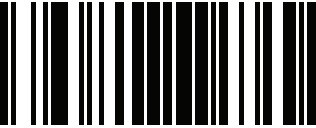
Code 128 – cont.

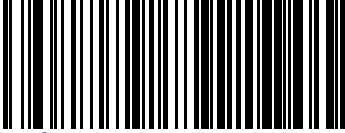
Code 128 Decoding Level – cont.

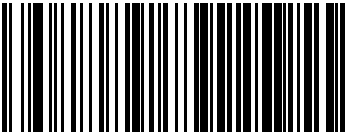
| | |
|--|---|
|  ENTER/EXIT PROGRAMMING MODE | |
|  Code 128 Decoding Level = 1 | |
| |  Code 128 Decoding Level = 2 |
|  Code 128 Decoding Level = 3 |  DEFAULT |
| |  Code 128 Decoding Level = 4 |
|  Code 128 Decoding Level = 5 | |

Code 128 – cont.

Code 128 Length Control

This feature specifies either variable length decoding or fixed length decoding for the Code 128 symbology.

Variable Length – For variable length decoding, a minimum and maximum length may be set.

Fixed Length – For fixed length decoding, two different lengths may be set.

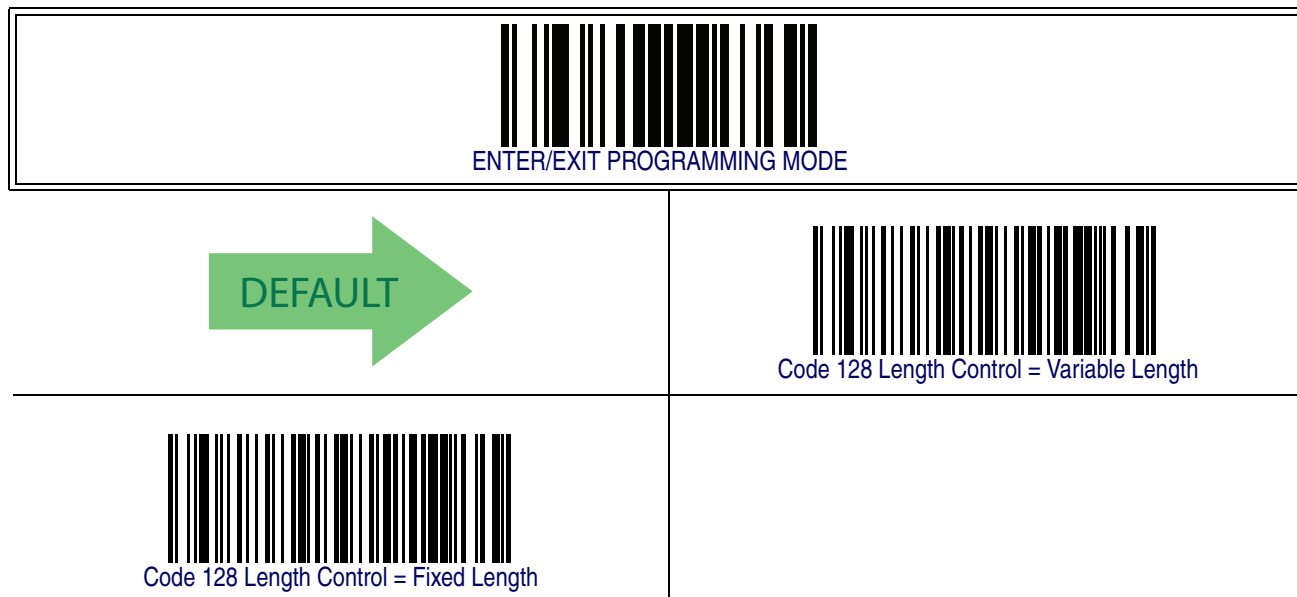

Code 128 – cont.

Code 128 Set Length 1

This feature specifies one of the barcode lengths for [Code 128 Length Control](#). Length 1 is the minimum label length if in [Variable Length](#) Mode, or the first fixed length if in [Fixed Length](#) Mode. Length includes the barcode’s data characters only. The length can be set from 1 to 80 characters.

Follow these instructions to set this feature:

1. Determine the desired character length (from 1 to 80). Pad the number with leading zeroes to yield two digits. For example: 0 = 00, 5 = 05, 20 = 20, etc.
2. Scan the ENTER/EXIT PROGRAMMING MODE barcode to enter Programming Mode.
3. Scan the barcode: SELECT CODE 128 LENGTH 1 SETTING.
4. Scan the appropriate two digits from the keypad in [Appendix E, Keypad](#), that represent the length setting which was determined in the steps above. You will hear a two-beep indication after the last character.



If you make a mistake before the last character, scan the CANCEL barcode to abort and not save the entry string. You can then start again at the beginning.

NOTE

5. Scan the ENTER/EXIT PROGRAMMING MODE barcode to exit Programming Mode.

This completes the procedure. See [Table 23](#) for some examples of how to set this feature.

Table 23. Code 128 Length 1 Setting Examples

| STEP | ACTION | EXAMPLES | | | |
|------|---|--------------|---------------|---------------|---------------|
| 1 | Desired Setting | 01 Character | 07 Characters | 15 Characters | 80 Characters |
| 2 | Scan ENTER/EXIT PROGRAMMING MODE | | | | |
| 3 | Scan SELECT CODE 128 LENGTH 1 SETTING | | | | |
| 4 | Scan Two Characters From Appendix E, Keypad | '0' and '1' | '0' and '7' | '1' and '5' | '8' AND '0' |
| 5 | Scan ENTER/EXIT PROGRAMMING MODE | | | | |

Code 128 – cont.

Code 128 Set Length 1 – cont.

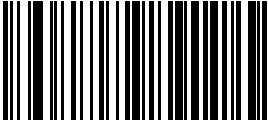
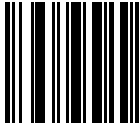
| | |
|--|---|
|  ENTER/EXIT PROGRAMMING MODE | |
|  Select Code 128 Set Length 1 Setting | |
| Make a mistake? Scan the CANCEL barcode to abort and not save the entry string. You can then start again at the beginning. |  CANCEL |

 01 = Length 1 is 1 Character

Code 128 – cont.

Code 128 Set Length 2

This feature specifies one of the barcode lengths for [Code 128 Length Control](#). Length 2 is the maximum label length if in [Variable Length Mode](#), or the second fixed length if in [Fixed Length Mode](#). Length includes the barcode’s data characters only.

The length can be set from 1 to 80 characters. A setting of 0 specifies to ignore this length (only one fixed length).

Follow these instructions to set this feature:

1. Determine the desired character length (from 1 to 80 — or 0 to ignore this length). Pad the number with leading zeroes to yield two digits. For example: 0 = 00, 5 = 05, 20 = 20, etc.
2. Scan the ENTER/EXIT PROGRAMMING MODE barcode to enter Programming Mode.
3. Scan the barcode: SELECT CODE 128 LENGTH 2 SETTING.
4. Scan the appropriate two digits from the keypad in [Appendix E, Keypad](#), that represent the length setting which was determined in the steps above. You will hear a two-beep indication after the last character.



If you make a mistake before the last character, scan the CANCEL barcode to abort and not save the entry string. You can then start again at the beginning.

NOTE

5. Scan the ENTER/EXIT PROGRAMMING MODE barcode to exit Programming Mode.

This completes the procedure. See [Table 24](#) for some examples of how to set this feature.

Table 24. Code 128 Length 2 Setting Examples

| STEP | ACTION | EXAMPLES | | | |
|------|---|-------------------------|---------------|---------------|---------------|
| 1 | Desired Setting | 00 (Ignore This Length) | 07 Characters | 15 Characters | 80 Characters |
| 2 | Scan ENTER/EXIT PROGRAMMING MODE | | | | |
| 3 | Scan SELECT CODE 128 LENGTH 2 SETTING | | | | |
| 4 | Scan Two Characters From Appendix E, Keypad | '0' and '0' | '0' and '7' | '0' and 'F' | '5' AND '0' |
| 5 | Scan ENTER/EXIT PROGRAMMING MODE | | | | |

Code 128 – cont.

Code 128 Set Length 2 – cont.

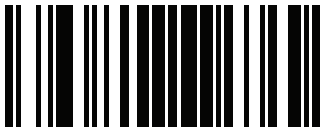
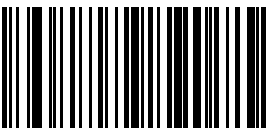
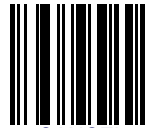
| | |
|--|---|
|  ENTER/EXIT PROGRAMMING MODE | |
|  Select Code 128 Length 2 Setting | |
| Make a mistake? Scan the CANCEL barcode to abort and not save the entry string. You can then start again at the beginning. |  CANCEL |

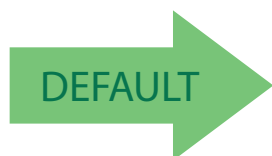

80 = Length 2 is 80 Characters

Code 128 – cont.

Code 128 Character Correlation

When correlation is enabled, the barcode reader will combine label data from multiple scans when decoding. Enabling correlation will help the scanner read labels that have some spots and/or voids. It may also help read labels that have damaged areas. Enabling correlation will also increase the chances that a label will be read incorrectly.

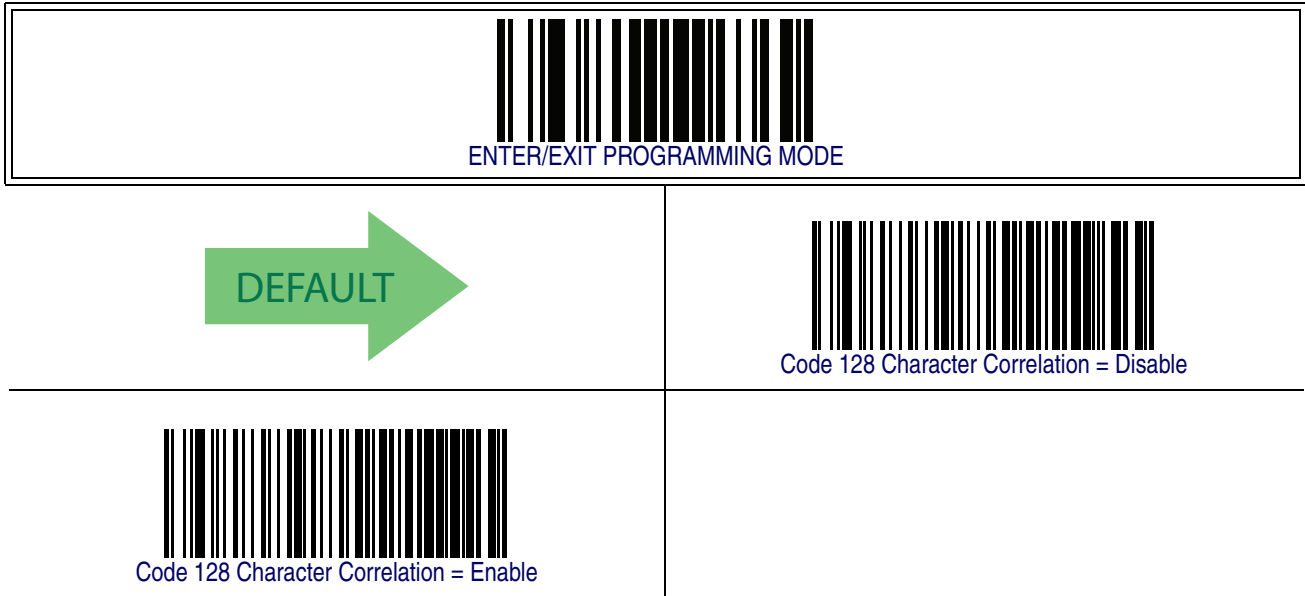

Code 128 – cont.

Code 128 Stitching

This option enables/disables stitching for Code 128 labels. When parts of a Code 128 barcode are presented to the reader with this feature enabled, the barcode parts will be assembled by the reader's software, and the data will be decoded if all barcode proofing requirements are met.



GS1-128

The following options apply to the GS1-128 symbology. (Also known as USS-128, GTIN-128, UCC-128, EAN 128.)

GS1-128 Enable

This option enables/disables the ability of the reader to translate GS1-128 labels to the GS1-128 data format. Options are:

- Transmit GS1-128 labels in Code 128 data format.
- Transmit GS1-128 labels in GS1-128 data format.
- Do not transmit GS1-128 labels.

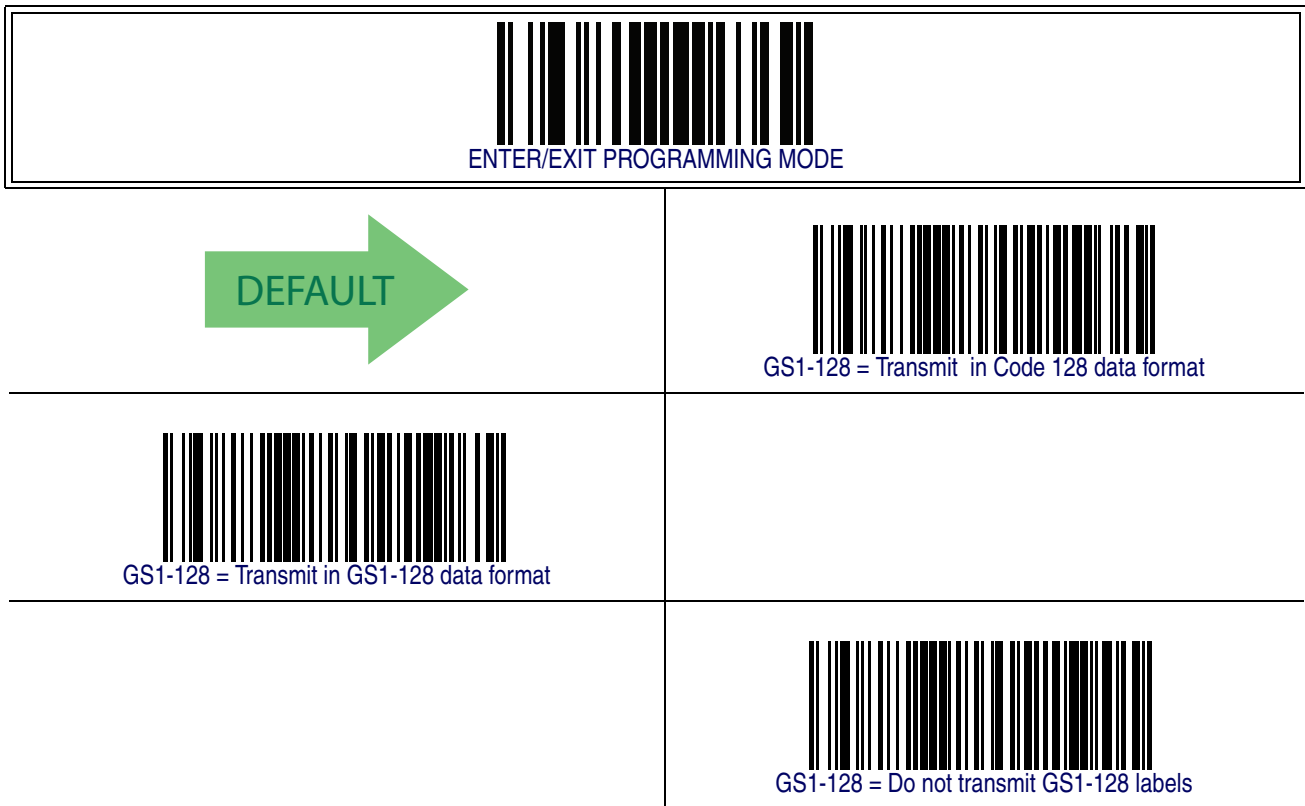

Interleaved 2 of 5 (I 2 of 5)

The following options apply to the I 2 of 5 symbology.

I 2 of 5 Enable/Disable

When disabled, the reader will not read I 2 of 5 barcodes.

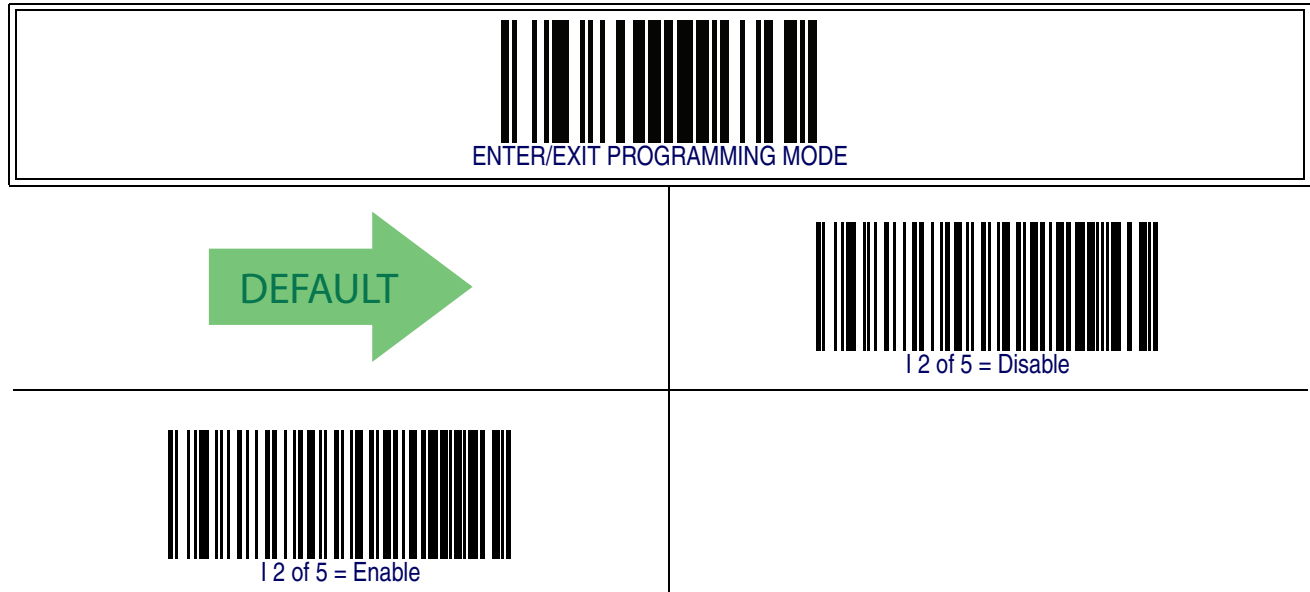

Interleaved 2 of 5 (I 2 of 5) – cont.

I 2 of 5 Check Character Calculation

This option enables/disables calculation and verification of an optional I 2 of 5 check character. When disabled, any check character in label is treated as a data character.

| | |
|---|---|
|  ENTER/EXIT PROGRAMMING MODE | |
|  |  I 2 of 5 Check Character Calculation = Disable |
|  I 2 of 5 Check Character Calculation = Check Standard (Modulo 10) | |
| |  I 2 of 5 Check Character Calculation = Check German Parcel |
|  I 2 of 5 Check Character Calculation = Check DHL | |
| |  I 2 of 5 Check Character Calculation = Check Daimler Chrysler |
|  I 2 of 5 Check Character Calculation = Check Bosch | |

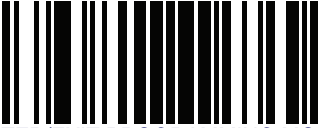
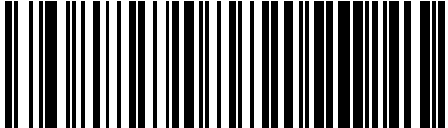

Interleaved 2 of 5 (I 2 of 5) – cont.

I 2 of 5 Check Character Calculation – cont.

| | |
|--|---|
|  ENTER/EXIT PROGRAMMING MODE | |
| |  I 2 of 5 Check Character Calculation = Check Italian Post |

I 2 of 5 Check Character Transmission

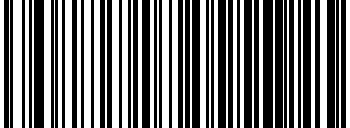
Enable this option to transmit the check character along with I 2 of 5 barcode data.

| | |
|---|--|
|  ENTER/EXIT PROGRAMMING MODE | |
| |  I 2 of 5 Check Character Transmission = Don't Send |
|  I 2 of 5 Check Character Transmission = Send |  DEFAULT |

Interleaved 2 of 5 (I 2 of 5) – cont.

I 2 of 5 Minimum Reads

This feature specifies the minimum number of consecutive times an I 2 of 5 label must be decoded before it is accepted as good read..



Interleaved 2 of 5 (I 2 of 5) – cont.

I 2 of 5 Decoding Level



This configuration item applies to Interleaved 2 of 5, Datalogic 2 of 5 and Standard 2 of 5.

NOTE





Decoding Levels are used to configure a barcode symbology decoder to be very aggressive to very conservative depending on a particular customer's needs.

- Choosing Level 1 results in a very conservative decoder at the expense of not being able to read poorly printed or damaged labels.
- Choosing Level 5 results in a very aggressive decoder. This aggressive behavior allows decoding of poorly printed and damaged labels at the expense of increasing the likelihood of decoding errors.
- Choosing Level 3, which is the default setting, allows the majority of product labels to be decoded.

There are many factors that determine when to change the decoding level for a particular symbology. These factors include spots, voids, non-uniform bar/space widths, damaged labels, etc. that may be experienced in some barcode labels. If there are many hard to read or damaged labels that cannot be decoded using a conservative setting, increase the decoding level to be more aggressive. If the majority of labels are very good quality labels, or there is a need to decrease the possibility of a decoder error, lower the decoding level to a more conservative level.

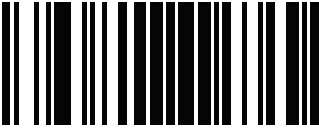
Interleaved 2 of 5 (I 2 of 5) – cont.

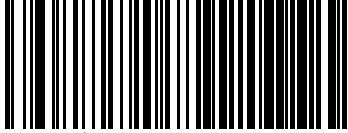
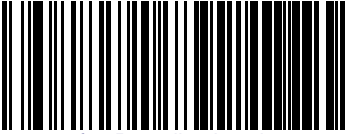
I 2 of 5 Decoding Level – cont.

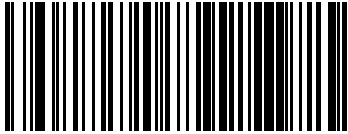
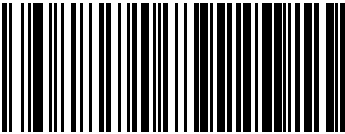
| | |
|--|---|
|  ENTER/EXIT PROGRAMMING MODE | |
|  2 of 5 Decoding Level = 1 | |
| |  2 of 5 Decoding Level = 2 |
|  2 of 5 Decoding Level = 3 |  DEFAULT |
| |  2 of 5 Decoding Level = 4 |
|  2 of 5 Decoding Level = 5 | |

Interleaved 2 of 5 (I 2 of 5) – cont.

I 2 of 5 Length Control

This feature specifies either variable length decoding or fixed length decoding for the I 2 of 5 symbology.

Variable Length – For variable length decoding, a minimum and maximum length may be set.

Fixed Length – For fixed length decoding, two different lengths may be set.



Interleaved 2 of 5 (I 2 of 5) – cont.

I 2 of 5 Set Length 1

This feature specifies one of the barcode lengths for **I 2 of 5 Length Control**. Length 1 is the minimum label length if in **Variable Length Mode**, or the first fixed length if in **Fixed Length Mode**. The length includes the barcode's check and data characters. The length can be set from 2 to 50 characters in increments of two.

Follow these instructions to set this feature:

1. Determine the desired character length (from 2 to 50). The length must be an even number.
2. Pad the result with leading zeroes to yield two digits. For example: 0 = 00, 5 = 05, 20 = 20, etc.
3. Scan the ENTER/EXIT PROGRAMMING MODE barcode to enter Programming Mode.
4. Scan the barcode: SELECT I 2 of 5 LENGTH 1 SETTING.
5. Scan the appropriate two digits from the keypad in [Appendix E, Keypad](#), that represent the length setting which was determined in the steps above. You will hear a two-beep indication after the last character.



If you make a mistake before the last character scan the CANCEL barcode to abort and not save the entry string. You can then start again at the beginning.

NOTE

6. Scan the ENTER/EXIT PROGRAMMING MODE barcode to exit Programming Mode.



This completes the procedure. See [Table 27](#) for some examples of how to set this feature.

Table 25. I 2 of 5 Length 1 Setting Examples

| STEP | ACTION | EXAMPLES | | | |
|------|---|--------------|--------------|---------------|---------------|
| 1 | Desired Setting | 2 Characters | 6 Characters | 14 Characters | 50 Characters |
| 2 | Pad with leading zeroes to yield two digits | 02 | 06 | 14 | 50 |
| 3 | Scan ENTER/EXIT PROGRAMMING MODE | | | | |
| 4 | Scan SELECT I 2 of 5 LENGTH 1 SETTING | | | | |
| 5 | Scan Two Characters From Appendix E, Keypad | '0' and '2' | '0' and '6' | '1' and '4' | '5' AND '0' |
| 6 | Scan ENTER/EXIT PROGRAMMING MODE | | | | |

Interleaved 2 of 5 (I 2 of 5) – cont.

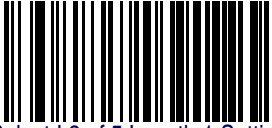
Datalogic 2 of 5 Set Length 1 – cont.

| | |
|--|---|
|  ENTER/EXIT PROGRAMMING MODE | |
|  Select I 2 of 5 Length 1 Setting | |
| Make a mistake? Scan the CANCEL barcode to abort and not save the entry string. You can then start again at the beginning. |  CANCEL |

 06 = Length 1 is 6 Characters

Interleaved 2 of 5 (I 2 of 5) – cont.

I 2 of 5 Set Length 2

This feature specifies one of the barcode lengths for **I 2 of 5 Length Control**. Length 2 is the maximum label length if in **Variable Length Mode**, or the second fixed length if in **Fixed Length Mode**. The length includes the barcode’s check and data characters. The length can be set from 2 to 50 characters. A setting of 0 specifies to ignore this length (only one fixed length).

Follow these instructions to set this feature:

1. Determine the desired character length (from 2 to 50, or 0 to ignore this length). The length must be an even number.
2. Pad the number with leading zeroes to yield two digits. For example: 0 = 00, 5 = 05, 20 = 20, etc.
3. Scan the ENTER/EXIT PROGRAMMING MODE barcode to enter Programming Mode.
4. Scan the barcode: SELECT I 2 of 5 LENGTH 2 SETTING.
5. Scan the appropriate two digits from the keypad in **Appendix E, Keypad**, that represent the length setting which was determined in the steps above. You will hear a two-beep indication after the last character.



NOTE

If you make a mistake before the last character, scan the **CANCEL** barcode to abort and not save the entry string. You can then start again at the beginning.

6. Scan the ENTER/EXIT PROGRAMMING MODE barcode to exit Programming Mode.

This completes the procedure. See **Table 28** for some examples of how to set this feature.

Table 26. I 2 of 5 Length 2 Setting Examples

| STEP | ACTION | EXAMPLES | | | |
|------|--|--------------------|--------------|---------------|---------------|
| | | Ignore This Length | 4 Characters | 14 Characters | 50 Characters |
| 1 | Desired Setting | | | | |
| 2 | Pad with leading zeroes to yield two digits | 00 | 04 | 14 | 50 |
| 3 | Scan ENTER/EXIT PROGRAMMING MODE | | | | |
| 4 | Scan SELECT I 2 OF 5 LENGTH 2 SETTING | | | | |
| 5 | Scan Two Characters From Appendix E, Keypad | '0' and '0' | '0' and '4' | '1' and '4' | '5' AND '0' |
| 6 | Scan ENTER/EXIT PROGRAMMING MODE | | | | |

Interleaved 2 of 5 (I 2 of 5) – cont.

I 2 of 5 Set Length 2 – cont.

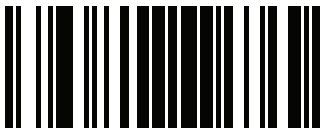
| |
|--|
|  ENTER/EXIT PROGRAMMING MODE |
|--|

| | |
|---|--|
|  Select I 2 of 5 Length 2 Setting | |
|---|--|

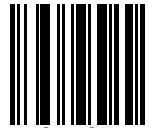
| | |
|--|---|
| Make a mistake? Scan the CANCEL barcode to abort and not save the entry string. You can then start again at the beginning. |  CANCEL |
|--|---|

 50 = Length 2 is 50 Characters

Interleaved 2 of 5 (I 2 of 5) – cont.

I 2 of 5 Character Correlation

When correlation is enabled, the barcode reader will combine label data from multiple scans when decoding. Enabling correlation will help the scanner read labels that have some spots and/or voids. It may also help read labels that have damaged areas. Enabling correlation will also increase the chances that a label will be read incorrectly.

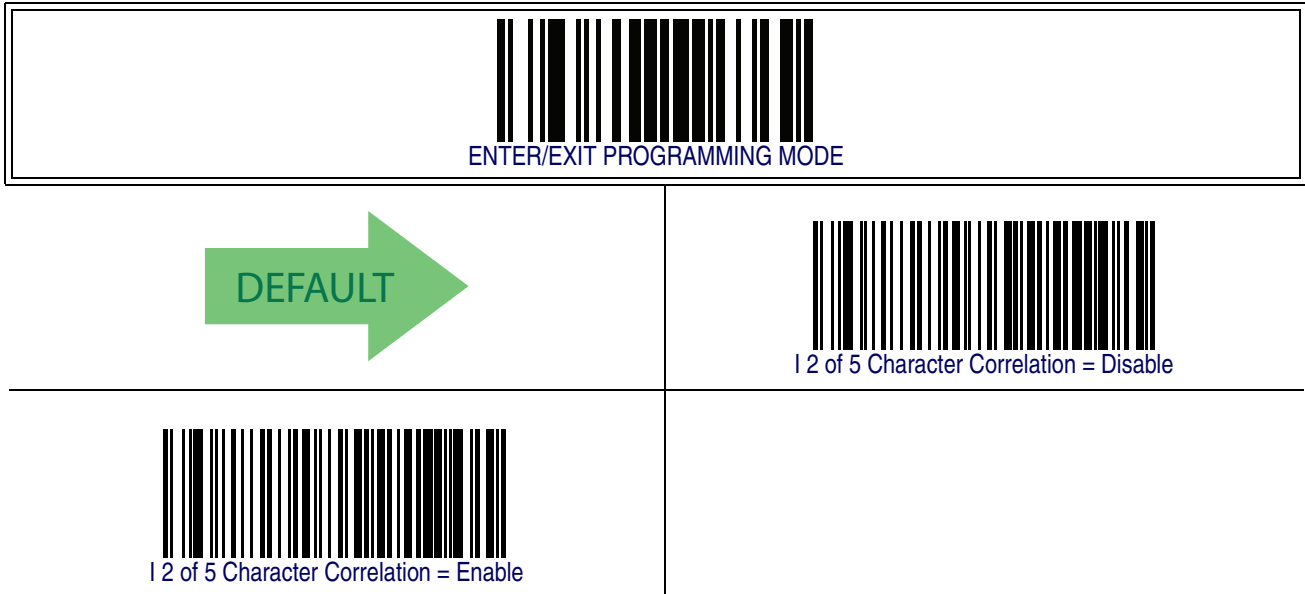

Interleaved 2 of 5 (I 2 of 5) – cont.

I 2 of 5 Stitching

This option enables/disables stitching for I 2 of 5 labels. When parts of a I 2 of 5 barcode are presented to the reader with this feature enabled, the barcode parts will be assembled by the reader's software, and the data will be decoded if all barcode proofing requirements are met.



Interleaved 2 of 5 CIP HR

The following options apply to the Interleaved 2 of 5 CIP HR symbology.

Interleaved 2 of 5 CIP HR Enable/Disable

Enables/Disables ability of reader to decode Interleaved 2 of 5 CIP HR labels.

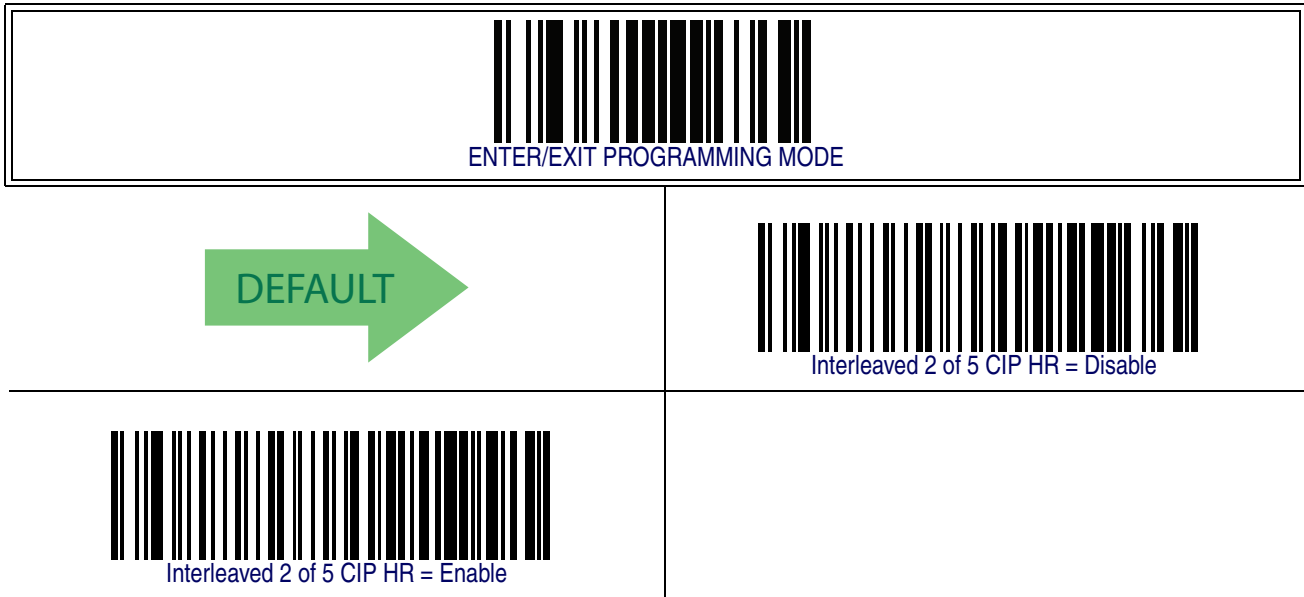

Datalogic 2 of 5

The following options apply to the Datalogic 2 of 5 symbology.

Datalogic 2 of 5 Enable/Disable

When disabled, the reader will not read Datalogic 2 of 5 barcodes.



Datalogic 2 of 5 – cont.

Datalogic 2 of 5 Check Character Calculation

This option enables/disables calculation and verification of an optional Datalogic 2 of 5 check character.

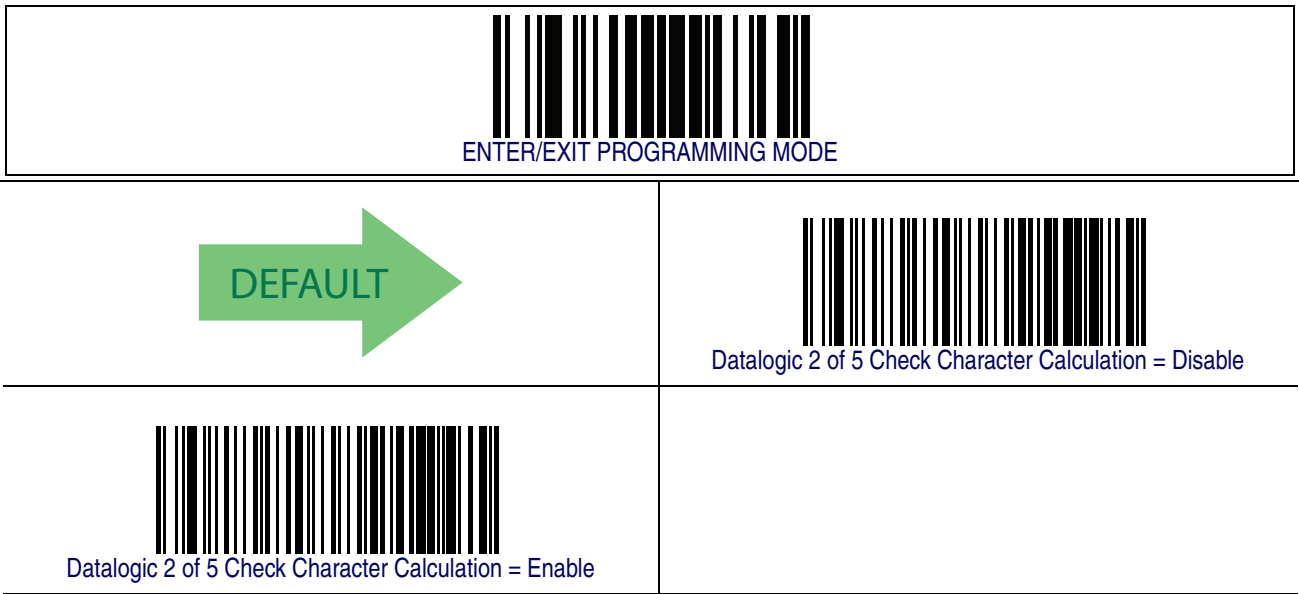

Datalogic 2 of 5 – cont.

Datalogic 2 of 5 Minimum Reads

This feature specifies the minimum number of consecutive times an Datalogic 2 of 5 label must be decoded before it is accepted as good read.

| | |
|--|--|
|  ENTER/EXIT PROGRAMMING MODE | |
|  |  1 of 5 Minimum Reads = 1 |
|  1 of 5 Minimum Reads = 2 | |
| |  1 of 5 Minimum Reads = 3 |
|  1 of 5 Minimum Reads = 4 | |

Datalogic 2 of 5 Decoding Level



The Datalogic 2 of 5 Decoding Level feature is set using 1 of 5 Decoding Level on page 211.

NOTE

Datalogic 2 of 5 – cont.

Datalogic 2 of 5 Length Control

This feature specifies either variable length decoding or fixed length decoding for the Datalogic 2 of 5 symbology.

Variable Length – For variable length decoding, a minimum and maximum length may be set.

Fixed Length – For fixed length decoding, two different lengths may be set.



Datalogic 2 of 5 – cont.

Datalogic 2 of 5 Set Length 1

This feature specifies one of the barcode lengths for [Datalogic 2 of 5 Length Control](#). Length 1 is the minimum label length if in [Variable Length](#) Mode, or the first fixed length if in [Fixed Length](#) Mode. The length includes the barcode’s check and data characters.

The length can be set from 2 to 50 characters in increments of two.

Follow these instructions to set this feature:

1. Determine the desired character length (from 2 to 50). The length must be an even number.
2. Pad the result with leading zeroes to yield two digits. For example: 0 = 00, 5 = 05, 20 = 20, etc.
3. Scan the ENTER/EXIT PROGRAMMING MODE barcode to enter Programming Mode.
4. Scan the barcode: SELECT I 2 of 5 LENGTH 1 SETTING.
5. Scan the appropriate two digits from the keypad in [Appendix E, Keypad](#), that represent the length setting which was determined in the steps above. You will hear a two-beep indication after the last character.



If you make a mistake before the last character scan the CANCEL barcode to abort and not save the entry string. You can then start again at the beginning.

NOTE

6. Scan the ENTER/EXIT PROGRAMMING MODE barcode to exit Programming Mode.

This completes the procedure. See [Table 27](#) for some examples of how to set this feature.

Table 27. Datalogic 2 of 5 Length 1 Setting Examples

| STEP | ACTION | EXAMPLES | | | |
|------|---|--------------|--------------|---------------|---------------|
| 1 | Desired Setting | 2 Characters | 6 Characters | 14 Characters | 50 Characters |
| 2 | Pad with leading zeroes to yield two digits | 02 | 06 | 14 | 50 |
| 3 | Scan ENTER/EXIT PROGRAMMING MODE | | | | |
| 4 | Scan SELECT Datalogic 2 of 5 LENGTH 1 SETTING | | | | |
| 5 | Scan Two Characters From Appendix E, Keypad | '0' and '2' | '0' and '6' | '1' and '4' | '5' AND '0' |
| 6 | Scan ENTER/EXIT PROGRAMMING MODE | | | | |

Datalogic 2 of 5 – cont.

Datalogic 2 of 5 Set Length 1 – cont.

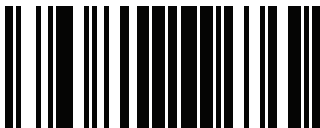
| |
|--|
|  ENTER/EXIT PROGRAMMING MODE |
|--|

| |
|---|
|  Select Datalogic 2 of 5 Length 1 Setting |
|---|

Make a mistake? Scan the CANCEL barcode to abort and not save the entry string. You can then start again at the beginning.

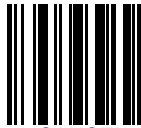
| |
|---|
|  CANCEL |
|---|

 06 = Length 1 is 6 Characters

Datalogic 2 of 5 – cont.

Datalogic 2 of 5 Set Length 2

This feature specifies one of the barcode lengths for [Datalogic 2 of 5 Length Control](#). Length 2 is the maximum label length if in [Variable Length](#) Mode, or the second fixed length if in [Fixed Length](#) Mode. The length includes the barcode's check and data characters.

The length can be set from 2 to 50 characters. A setting of 0 specifies to ignore this length (only one fixed length).

Follow these instructions to set this feature:

1. Determine the desired character length (from 2 to 50, or 0 to ignore this length). The length must be an even number.
2. Pad the number with leading zeroes to yield two digits. For example: 0 = 00, 5 = 05, 20 = 20, etc.
3. Scan the ENTER/EXIT PROGRAMMING MODE barcode to enter Programming Mode.
4. Scan the barcode: SELECT Datalogic 2 of 5 LENGTH 2 SETTING.
5. Scan the appropriate two digits from the keypad in [Appendix E, Keypad](#), that represent the length setting which was determined in the steps above. You will hear a two-beep indication after the last character.



If you make a mistake before the last character, scan the CANCEL barcode to abort and not save the entry string. You can then start again at the beginning.

NOTE

6. Scan the ENTER/EXIT PROGRAMMING MODE barcode to exit Programming Mode.

This completes the procedure. See [Table 28](#) for some examples of how to set this feature.

Table 28. Datalogic 2 of 5 Length 2 Setting Examples

| STEP | ACTION | EXAMPLES | | | |
|------|---|--------------------|--------------|---------------|---------------|
| 1 | Desired Setting | Ignore This Length | 4 Characters | 14 Characters | 50 Characters |
| 2 | Pad with leading zeroes to yield two digits | 00 | 04 | 14 | 50 |
| 3 | Scan ENTER/EXIT PROGRAMMING MODE | | | | |
| 4 | Scan SELECT DATALOGIC 2 OF 5 LENGTH 2 SETTING | | | | |
| 5 | Scan Two Characters From Appendix E, Keypad | '0' and '0' | '0' and '4' | '1' and '4' | '5' AND '0' |
| 6 | Scan ENTER/EXIT PROGRAMMING MODE | | | | |

Datalogic 2 of 5 – cont.

Datalogic 2 of 5 Set Length 2 – cont.

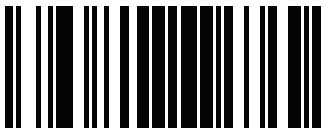
| |
|--|
|  ENTER/EXIT PROGRAMMING MODE |
|--|

| |
|---|
|  Select Datalogic 2 of 5 Length 2 Setting |
|---|

Make a mistake? Scan the CANCEL barcode to abort and not save the entry string. You can then start again at the beginning.

| |
|---|
|  CANCEL |
|---|

 50 = Length 2 is 50 Characters

Datalogic 2 of 5 – cont.

Datalogic 2 of 5 Interdigit Maximum Ratio

This feature specifies the maximum ratio between intercharacter space and module for Datalogic 2 of 5.

| | |
|--|---|
|  ENTER/EXIT PROGRAMMING MODE | |
| |  Datalogic 2 of 5 Interdigit Maximum Ratio = Disable |
|  Datalogic 2 of 5 Interdigit Maximum Ratio = 1 | |
| |  Datalogic 2 of 5 Interdigit Maximum Ratio = 2 |
|  Datalogic 2 of 5 Interdigit Maximum Ratio = 3 | |
|  DEFAULT |  Datalogic 2 of 5 Interdigit Maximum Ratio = 4 |
|  Datalogic 2 of 5 Interdigit Maximum Ratio = 5 | |

Datalogic 2 of 5 Interdigit Maximum Ratio – cont.

| | |
|---|--|
| |  <p>Datalogic 2 of 5 Interdigit Maximum Ratio = 6</p> |
|  <p>Datalogic 2 of 5 Interdigit Maximum Ratio = 7</p> | |
| |  <p>Datalogic 2 of 5 Interdigit Maximum Ratio = 8</p> |
|  <p>Datalogic 2 of 5 Interdigit Maximum Ratio = 9</p> | |
| |  <p>Datalogic 2 of 5 Interdigit Maximum Ratio = 10</p> |

Datalogic 2 of 5 – cont.

Datalogic 2 of 5 Character Correlation

When correlation is enabled, the barcode reader will combine label data from multiple scans when decoding. Enabling correlation will help the scanner read labels that have some spots and/or voids. It may also help read labels that have damaged areas. Enabling correlation will also increase the chances that a label will be read incorrectly.

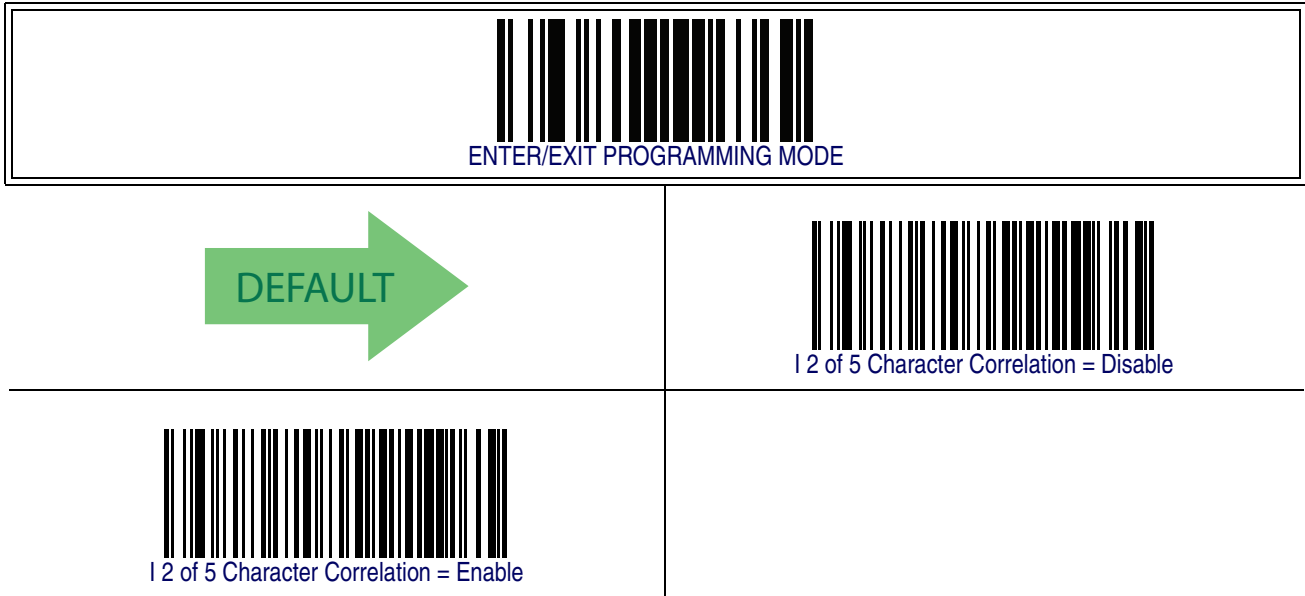

Datalogic 2 of 5 – cont.

Datalogic 2 of 5 Stitching

This option enables/disables stitching for Datalogic 2 of 5 labels. When parts of a Datalogic 2 of 5 barcode are presented to the reader with this feature enabled, the barcode parts will be assembled by the reader’s software, and the data will be decoded if all barcode proofing requirements are met.



Codabar

The following options apply to the Codabar symbology.

Codabar Enable/Disable

When disabled, the reader will not read Codabar barcodes.

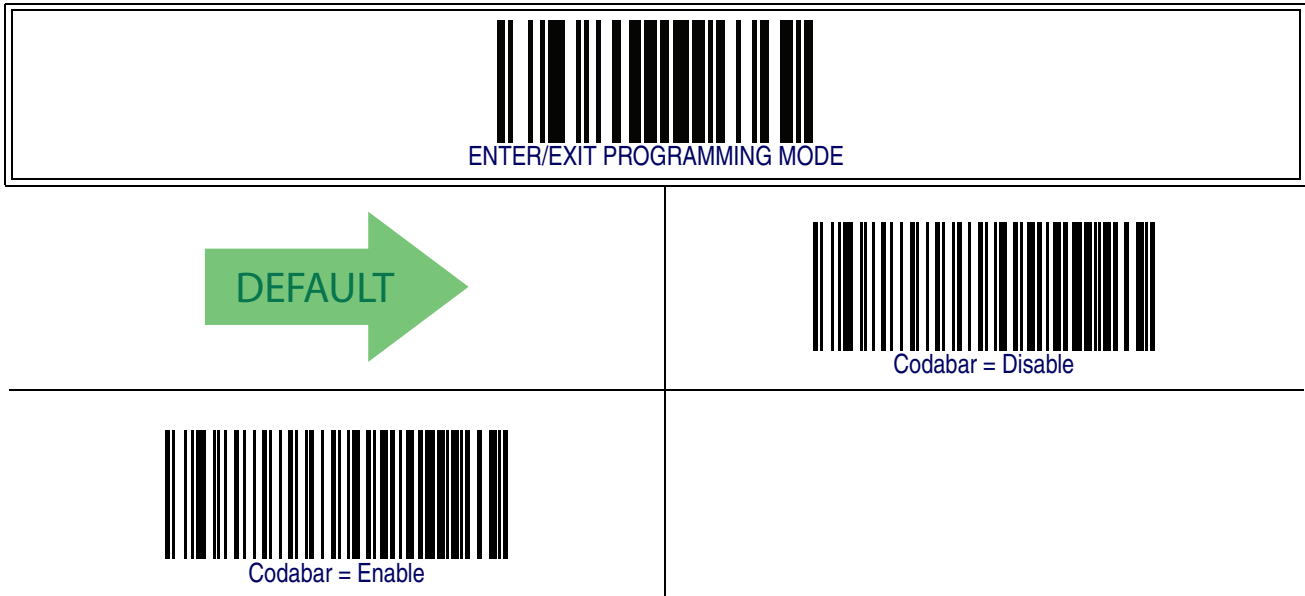

Codabar — cont.

Codabar Check Character Calculation

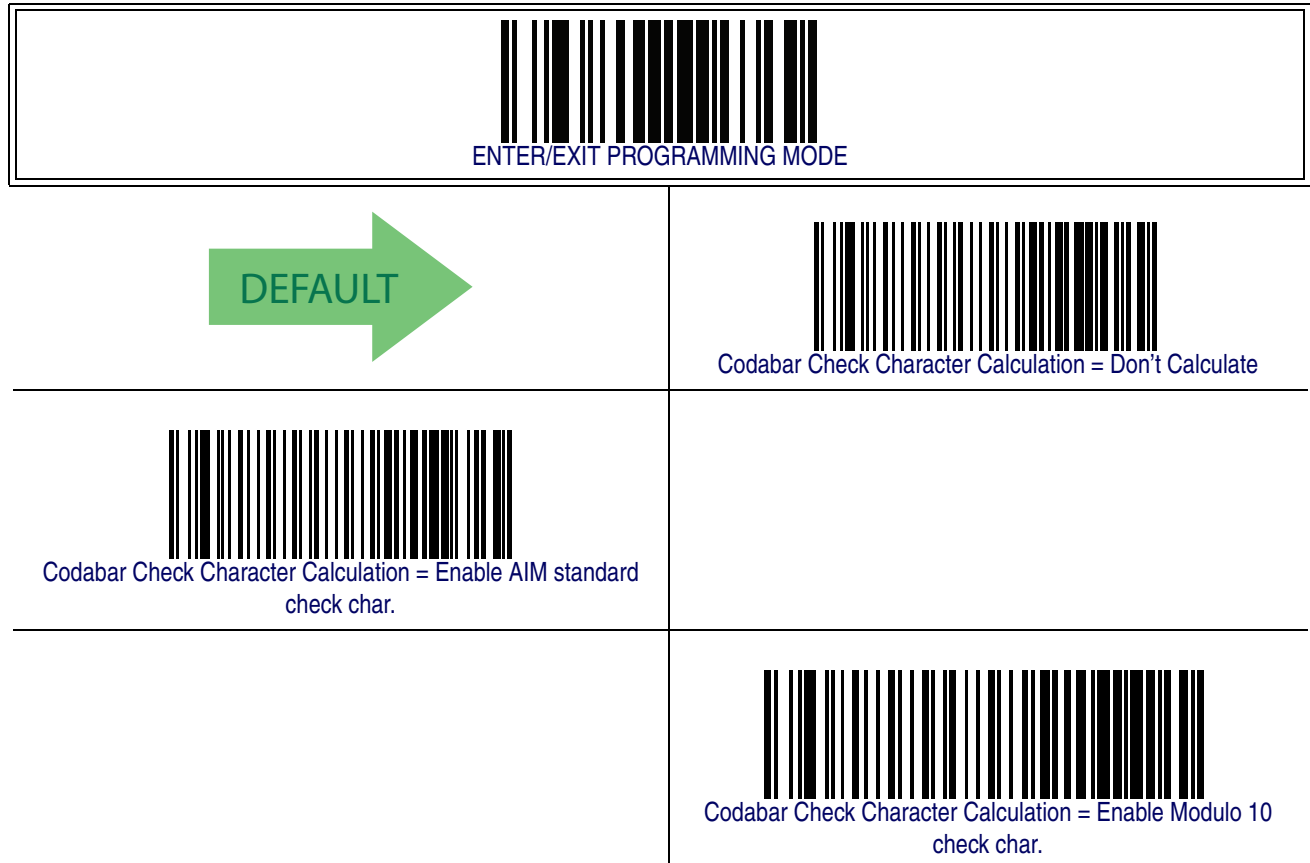

Enable this option to enables/disables calculation and verification of an optional Codabar check character. When disabled, any check character in the label is treated as a data character



Codabar – cont.

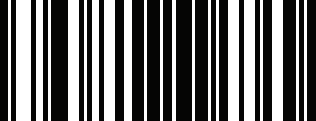
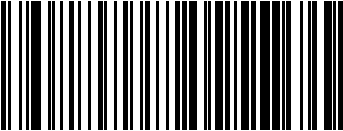
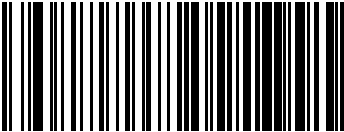

Codabar Check Character Transmission

Enable this option to transmit the check character along with Codabar barcode data.

| | |
|--|---|
|  ENTER/EXIT PROGRAMMING MODE | |
| |  Codabar Check Character Transmission = Don't Send |
|  Codabar Check Character Transmission = Send |  DEFAULT |

Codabar Start/Stop Character Transmission

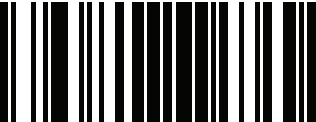
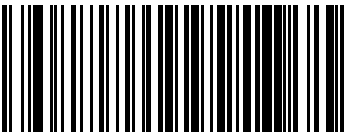
Enable this option to enable/disable transmission of Codabar start and stop characters.

| | |
|---|--|
|  ENTER/EXIT PROGRAMMING MODE | |
| |  Codabar Start/Stop Character Transmission = Don't Transmit |
|  Codabar Start/Stop Character Transmission = Transmit |  DEFAULT |

Codabar — cont.

Codabar Start/Stop Character Set

This option specifies the format of transmitted Codabar start/stop characters.

| | |
|--|--|
|  <p>ENTER/EXIT PROGRAMMING MODE</p> | |
| |  <p>Codabar Check Character Set = ABCD/TN*E</p> |
|  <p>Codabar Check Character Set = ABCD/ABCD</p> | |
| |  <p>Codabar Check Character Set = abcd/tn*e</p> |
|  <p>Codabar Check Character Set = abcd/abcd</p> |  <p>DEFAULT</p> |

Codabar – cont.

Codabar Start/Stop Character Match

When enabled, this option requires that start and stop characters match.

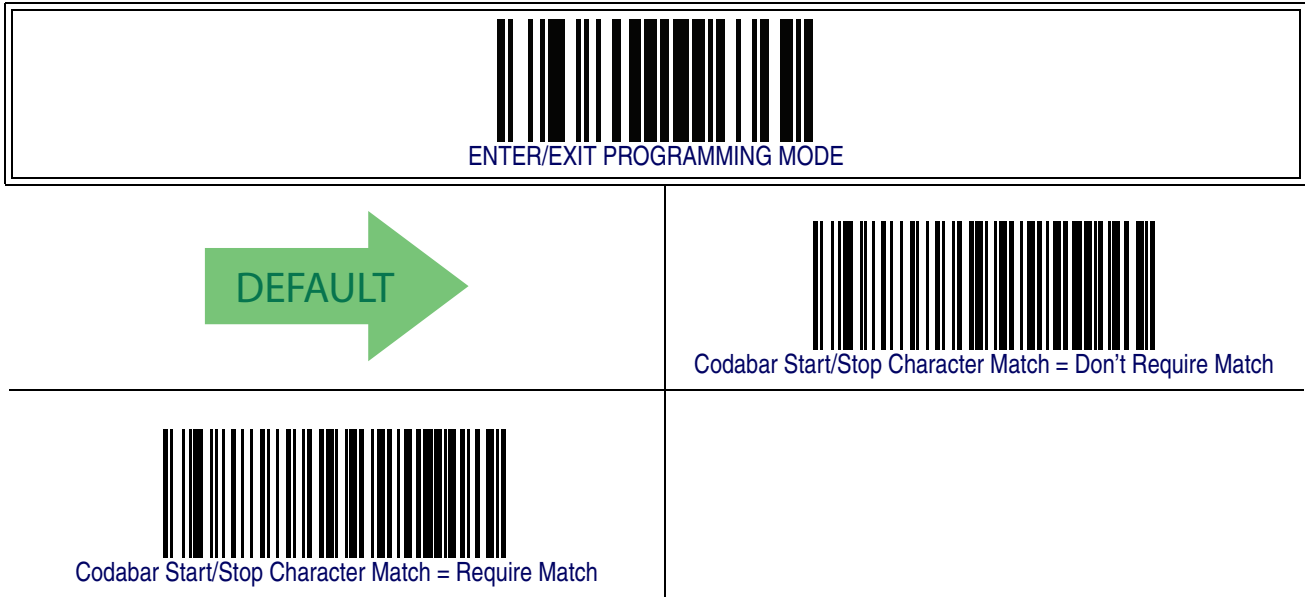

Codabar — cont.

Codabar Quiet Zones

This feature specifies the number of quiet zones for Codabar labels. Quiet zones are blank areas at the ends of a barcode and are typically 10 times the width of the narrowest bar or space in the label.

| | |
|---|--|
|  ENTER/EXIT PROGRAMMING MODE | |
|  Codabar Quiet Zones = Quiet Zone on one side | |
| |  Codabar Quiet Zones = Quiet Zones on two sides |
|  Codabar Quiet Zones = Auto |  DEFAULT |
| |  Codabar Quiet Zones = Virtual Quiet Zones on two sides |
|  Codabar Quiet Zones = Small Quiet Zones on two sides | |

Codabar – cont.

Codabar Minimum Reads

This feature specifies the minimum number of consecutive times a Codabar label must be decoded before it is accepted as good read..



Codabar — cont.

Codabar Decoding Level



Decoding Levels are used to configure a barcode symbology decoder to be very aggressive to very conservative depending on a particular customer's needs.

- Choosing Level 1 results in a very conservative decoder at the expense of not being able to read poorly printed or damaged labels.
- Choosing Level 5 results in a very aggressive decoder. This aggressive behavior allows decoding of poorly printed and damaged labels at the expense of increasing the likelihood of decoding errors.
- Choosing Level 3, which is the default setting, allows the majority of product labels to be decoded.

There are many factors that determine when to change the decoding level for a particular symbology. These factors include spots, voids, non-uniform bar/space widths, damaged labels, etc. that may be experienced in some barcode labels. If there are many hard to read or damaged labels that cannot be decoded using a conservative setting, increase the decoding level to be more aggressive. If the majority of labels are very good quality labels, or there is a need to decrease the possibility of a decoder error, lower the decoding level to a more conservative level.

Codabar – cont.

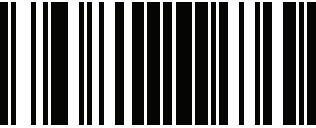
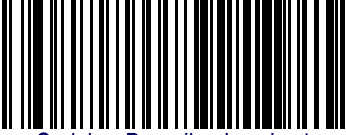
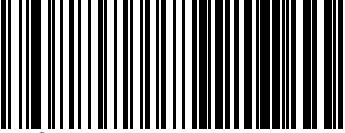
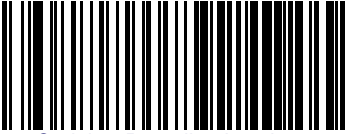
Codabar Decoding Level – cont.

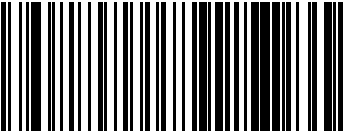
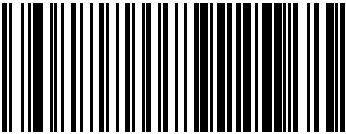
| | |
|---|--|
|  ENTER/EXIT PROGRAMMING MODE | |
|  Codabar Decoding Level = 1 | |
| |  Codabar Decoding Level = 2 |
|  Codabar Decoding Level = 3 |  DEFAULT |
| |  Codabar Decoding Level = 4 |
|  Codabar Decoding Level = 5 | |

Codabar — cont.

Codabar Length Control

This feature specifies either variable length decoding or fixed length decoding for the Codabar symbology.

Variable Length — For variable length decoding, a minimum and maximum length may be set.

Fixed Length — For fixed length decoding, two different lengths may be set.

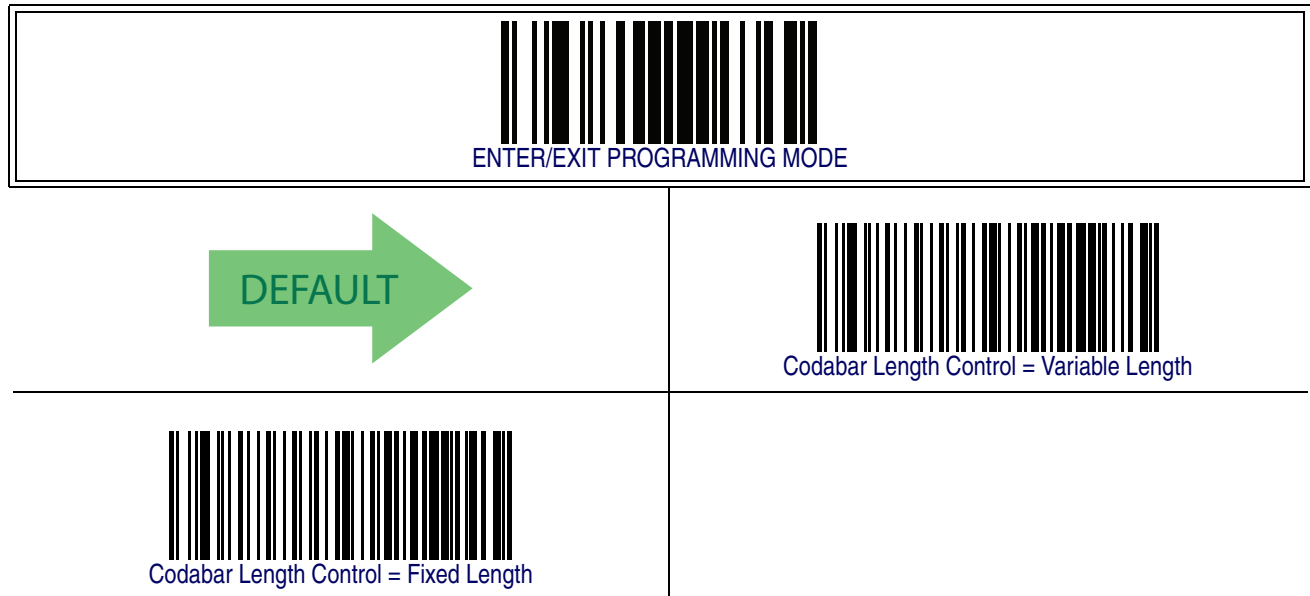

Codabar – cont.

Codabar Set Length 1

This feature specifies one of the barcode lengths for **Codabar Length Control**. Length 1 is the minimum label length if in **Variable Length Mode**, or the first fixed length if in **Fixed Length Mode**. Length includes the barcode’s start, stop, check and data characters. The length must include at least one data character.

The length can be set from 3 to 50 characters.

Follow these instructions to set this feature:

1. Determine the desired character length (from 3 to 50). Pad the number with leading zeroes to yield two digits. For example: 0 = 00, 5 = 05, 20 = 20, etc.
2. Scan the ENTER/EXIT PROGRAMMING MODE barcode to enter Programming Mode.
3. Scan the barcode: SELECT CODABAR LENGTH 1 SETTING.
4. Scan the appropriate two digits from the keypad in **Appendix E, Keypad**, that represent the length setting which was determined in the steps above. You will hear a two-beep indication after the last character.



If you make a mistake before the last character, scan the CANCEL barcode to abort and not save the entry string. You can then start again at the beginning.

NOTE

5. Scan the ENTER/EXIT PROGRAMMING MODE barcode to exit Programming Mode.

This completes the procedure. See **Table 29** for some examples of how to set this feature.

Table 29. Codabar Length 1 Setting Examples

| STEP | ACTION | EXAMPLES | | | |
|------|---|---------------|---------------|---------------|---------------|
| 1 | Desired Setting (and pad with leading zeroes) | 03 Characters | 09 Characters | 15 Characters | 50 Characters |
| 2 | Scan ENTER/EXIT PROGRAMMING MODE | | | | |
| 3 | Scan SELECT CODABAR LENGTH 1 SETTING | | | | |
| 4 | Scan Two Characters From Appendix E, Keypad | '0' and '3' | '0' and '9' | '1' and '5' | '5' AND '0' |
| 5 | Scan ENTER/EXIT PROGRAMMING MODE | | | | |

Codabar – cont.

Codabar Set Length 1 – cont.

| |
|--|
|  ENTER/EXIT PROGRAMMING MODE |
|--|

| |
|--|
|  Select Codabar Length 1 Setting |
|--|

| |
|--|
| |
|--|

Make a mistake? Scan the CANCEL barcode to abort and not save the entry string. You can then start again at the beginning.

| |
|---|
|  CANCEL |
|---|

 03 = Length 1 is 3 Characters

Codabar – cont.

Codabar Set Length 2

This feature specifies one of the barcode lengths for [Codabar Length Control](#). Length 2 is the maximum label length if in [Variable Length Mode](#), or the second fixed length if in [Fixed Length Mode](#). The length includes the barcode’s start, stop, check and data characters. The length must include at least one data character.

The length can be set from 3 to 50 characters. A setting of 0 specifies to ignore this length (only one fixed length).

Follow these instructions to set this feature:

1. Determine the desired character length (from 3 to 50 — or 0 to ignore this length). Pad the number with leading zeroes to yield two digits. For example: 0 = 00, 5 = 05, 20 = 20, etc.
2. Scan the ENTER/EXIT PROGRAMMING MODE barcode to enter Programming Mode.
3. Scan the barcode: SELECT CODABAR LENGTH 2 SETTING.
4. Scan the appropriate two digits from the keypad in [Appendix E, Keypad](#), that represent the length setting which was determined in the steps above. You will hear a two-beep indication after the last character.



If you make a mistake before the last character, scan the CANCEL barcode to abort and not save the entry string. You can then start again at the beginning.

NOTE

5. Scan the ENTER/EXIT PROGRAMMING MODE barcode to exit Programming Mode.

This completes the procedure. See [Table 30](#) for some examples of how to set this feature.

Table 30. Codabar Length 2 Setting Examples

| STEP | ACTION | EXAMPLES | | | |
|------|---|-----------------------|---------------|---------------|---------------|
| 1 | Desired Setting (and pad with leading zeroes) | 00 Ignore This Length | 07 Characters | 15 Characters | 50 Characters |
| 2 | Scan ENTER/EXIT PROGRAMMING MODE | | | | |
| 3 | Scan SELECT CODE 39 LENGTH 2 SETTING | | | | |
| 4 | Scan Two Characters From Appendix E, Keypad | '0' and '0' | '0' and '7' | '1' and '5' | '5' AND '0' |
| 5 | Scan ENTER/EXIT PROGRAMMING MODE | | | | |

Codabar – cont.

Codabar Set Length 2 – cont.

| |
|--|
|  ENTER/EXIT PROGRAMMING MODE |
|--|

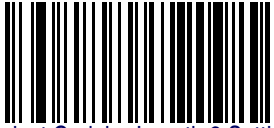
| | |
|---|--|
|  Select CodabarLength 2 Setting | |
|---|--|

| | |
|--|---|
| Make a mistake? Scan the CANCEL barcode to abort and not save the entry string. You can then start again at the beginning. |  CANCEL |
|--|---|

 50 = Length 2 is 50 Characters

Codabar — cont.

Codabar Interdigit Ratio

This feature specifies the ratio between an intercharacter space and module for Codabar labels.

| | |
|---|--|
|  ENTER/EXIT PROGRAMMING MODE | |
| |  Codabar Interdigit Ratio = Disable |
|  Codabar Interdigit Ratio = 1 | |
| |  Codabar Interdigit Ratio = 2 |
|  Codabar Interdigit Ratio = 3 | |
|  DEFAULT |  Codabar Interdigit Ratio = 4 |
|  Codabar Interdigit Ratio = 5 | |

Codabar — cont.

Codabar Interdigit Ratio — cont.

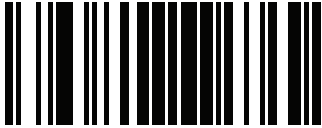
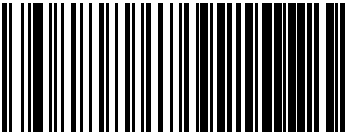
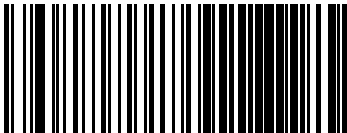
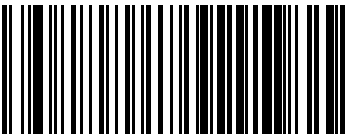
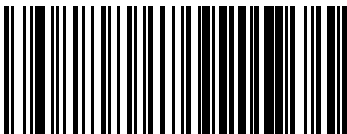
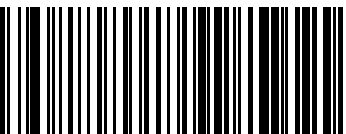
| | |
|---|---|
|  ENTER/EXIT PROGRAMMING MODE | |
| |  Codabar Interdigit Ratio = 6 |
|  Codabar Interdigit Ratio = 7 | |
| |  Codabar Interdigit Ratio = 8 |
|  Codabar Interdigit Ratio = 9 | |
| |  Codabar Interdigit Ratio = 10 |

Codabar – cont.

Codabar Character Correlation

When correlation is enabled, the barcode reader will combine label data from multiple scans when decoding. Enabling correlation will help the scanner read labels that have some spots and/or voids. It may also help read labels that have damaged areas. Enabling correlation will also increase the chances that a label will be read incorrectly.

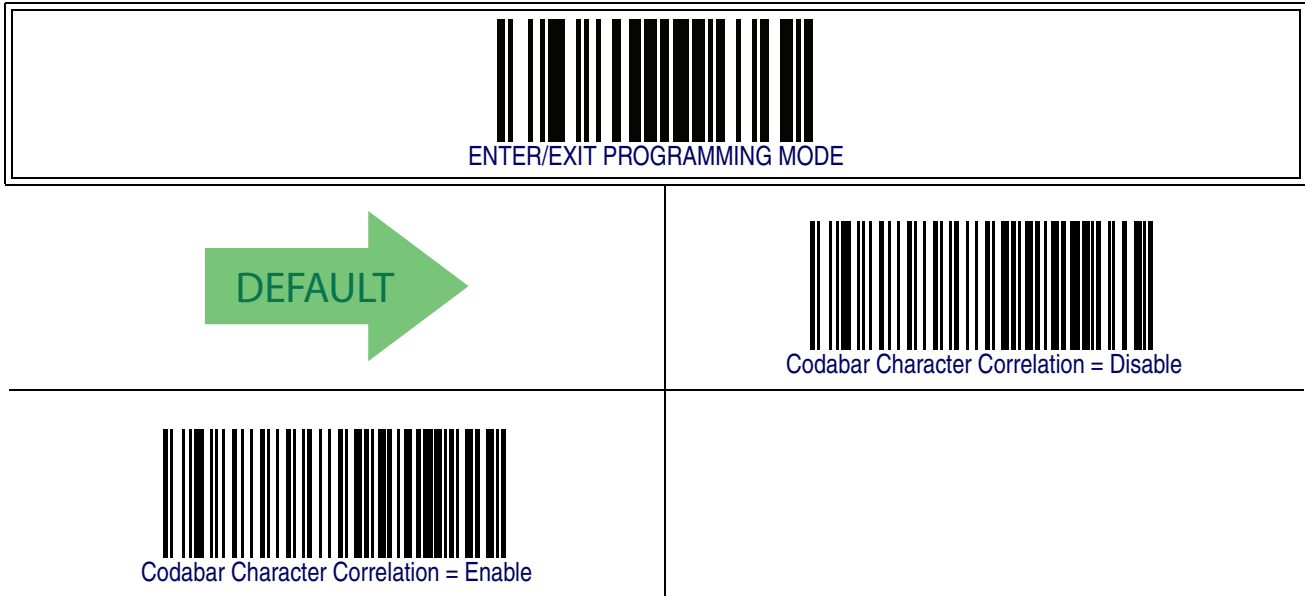

Codabar — cont.

Codabar Stitching

This option enables/disables stitching for Codabar labels. When parts of a Codabar barcode are presented to the reader with this feature enabled, the barcode parts will be assembled by the reader's software, and the data will be decoded if all barcode proofing requirements are met.

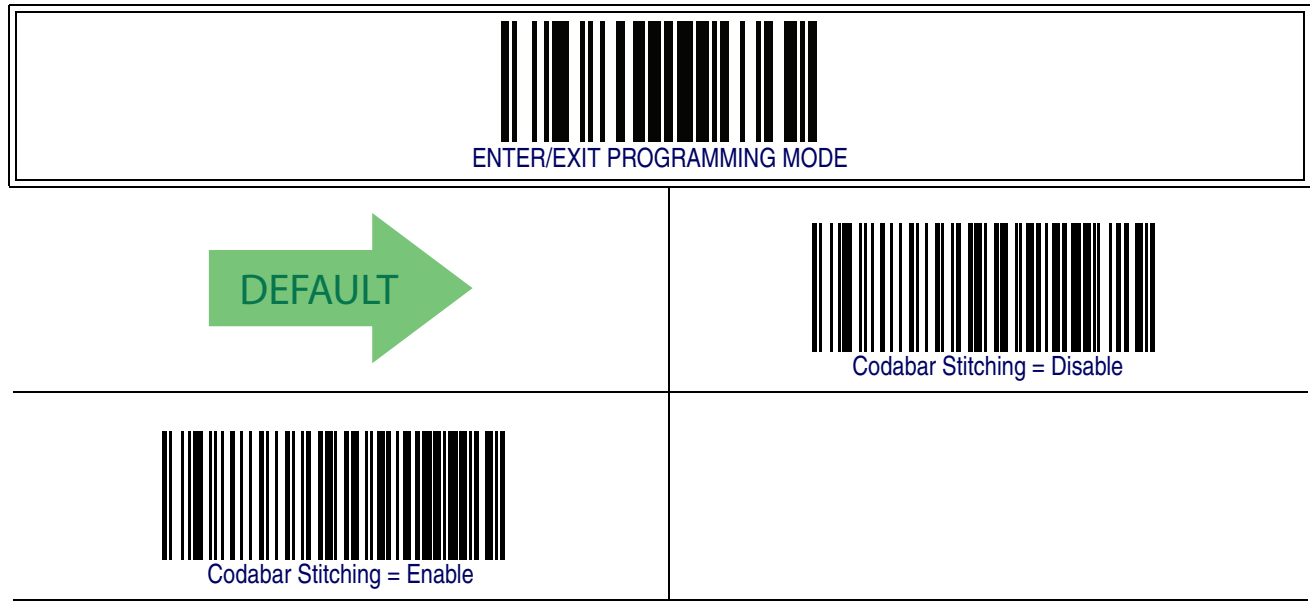

ABC Codabar

The following options apply to the ABC Codabar symbology.

ABC Codabar Enable/Disable

Enables/Disables ability of reader to decode ABC Codabar labels.



ABC Codabar Concatenation Mode

Specifies the concatenation mode between Static and Dynamic.

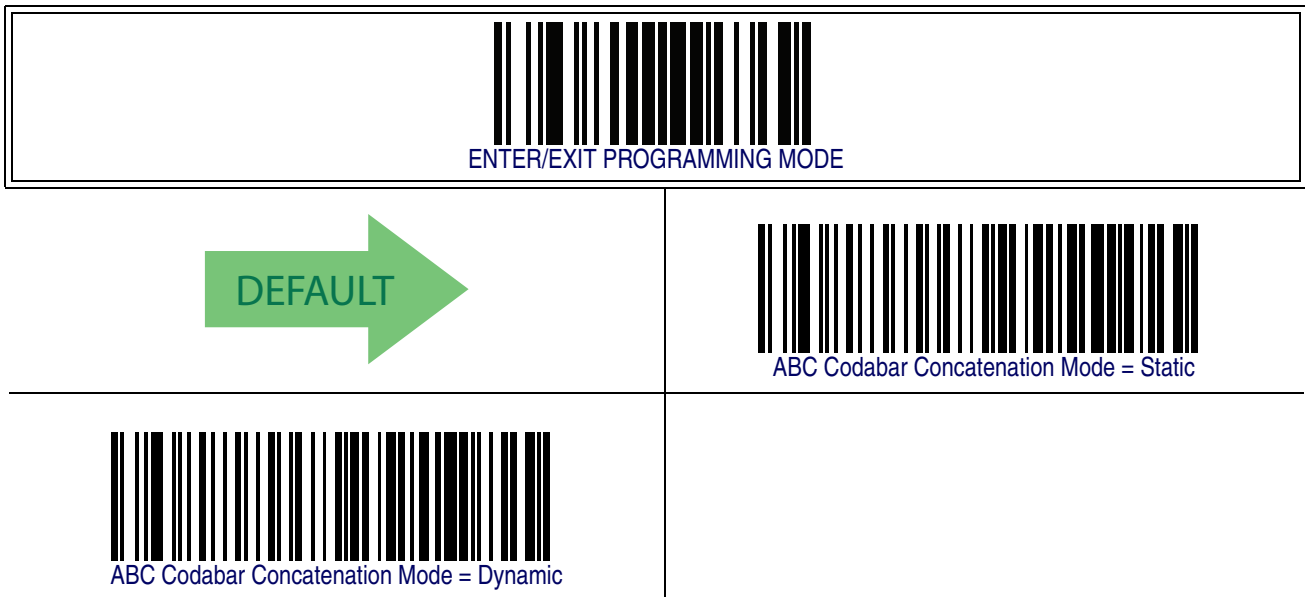

ABC Codabar – cont.

ABC Codabar Dynamic Concatenation Timeout

Specifies the timeout in 10-millisecond ticks used by the ABC Codabar Dynamic Concatenation Mode.

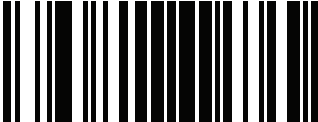
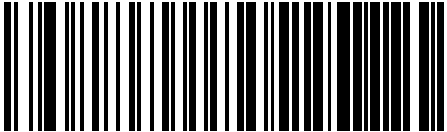
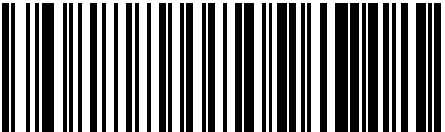
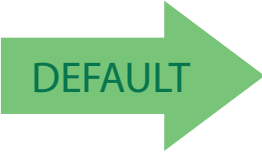
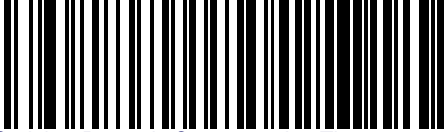
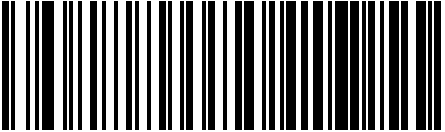
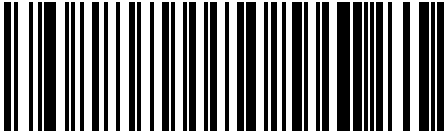
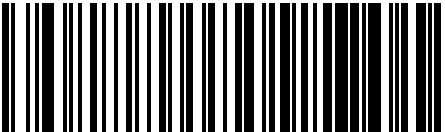
| | |
|---|--|
|  ENTER/EXIT PROGRAMMING MODE | |
| |  ABC Codabar Dynamic Concatenation Timeout = 50 msec |
|  ABC Codabar Dynamic Concatenation Timeout = 100 msec | |
|  |  ABC Codabar Dynamic Concatenation Timeout = 200 msec |
|  ABC Codabar Dynamic Concatenation Timeout = 500 msec | |
| |  ABC Codabar Dynamic Concatenation Timeout = 750 msec |
|  ABC Codabar Dynamic Concatenation Timeout = 1 Second | |

ABC Codabar — cont.

ABC Codabar Force Concatenation

Forces labels starting or ending with D to be concatenated.



Code 11

The following options apply to the Code 11 symbology.

Code 11 Enable/Disable

When disabled, the reader will not read Code 11 barcodes.

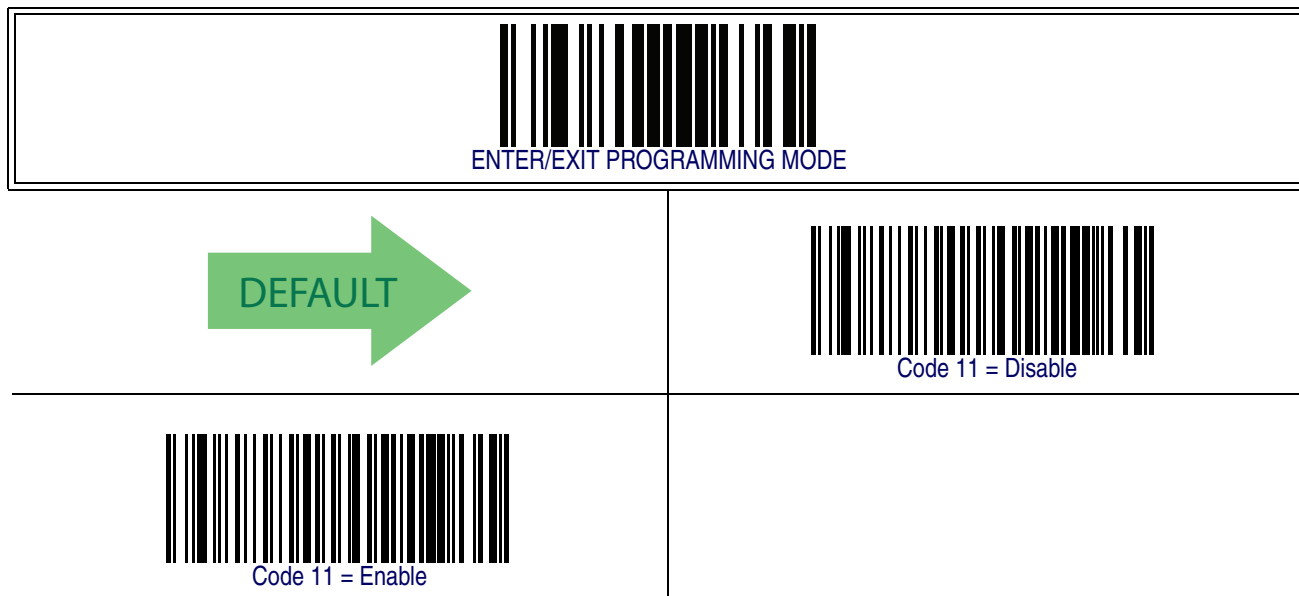

Code 11 – cont.

Code 11 Check Character Calculation

This option enables/disables calculation and verification of optional Code 11 check character.

| | |
|--|--|
|  ENTER/EXIT PROGRAMMING MODE | |
| |  Code 11 Check Character Calculation = Disable |
|  Code 11 Check Character Calculation = Check C | |
| |  Code 11 Check Character Calculation = Check K |
|  Code 11 Check Character Calculation = Check C and K |  |

Code 11 – cont.

Code 11 Check Character Transmission

This feature enables/disables transmission of an optional Code 11 check character.

| | |
|--|---|
|  ENTER/EXIT PROGRAMMING MODE | |
| |  Code 11 Check Character Transmission = Don't Send |
|  Code 11 Check Character Transmission = Send |  |

Code 11 – cont.

Code 11 Minimum Reads

This feature specifies the minimum number of consecutive times a Code 93 label must be decoded before it is accepted as good read..



Code 11 — cont.

Code 11 Length Control

This feature specifies either variable length decoding or fixed length decoding for the Code 11 symbology.

Variable Length — For variable length decoding, a minimum and maximum length may be set.

Fixed Length — For fixed length decoding, two different lengths may be set.

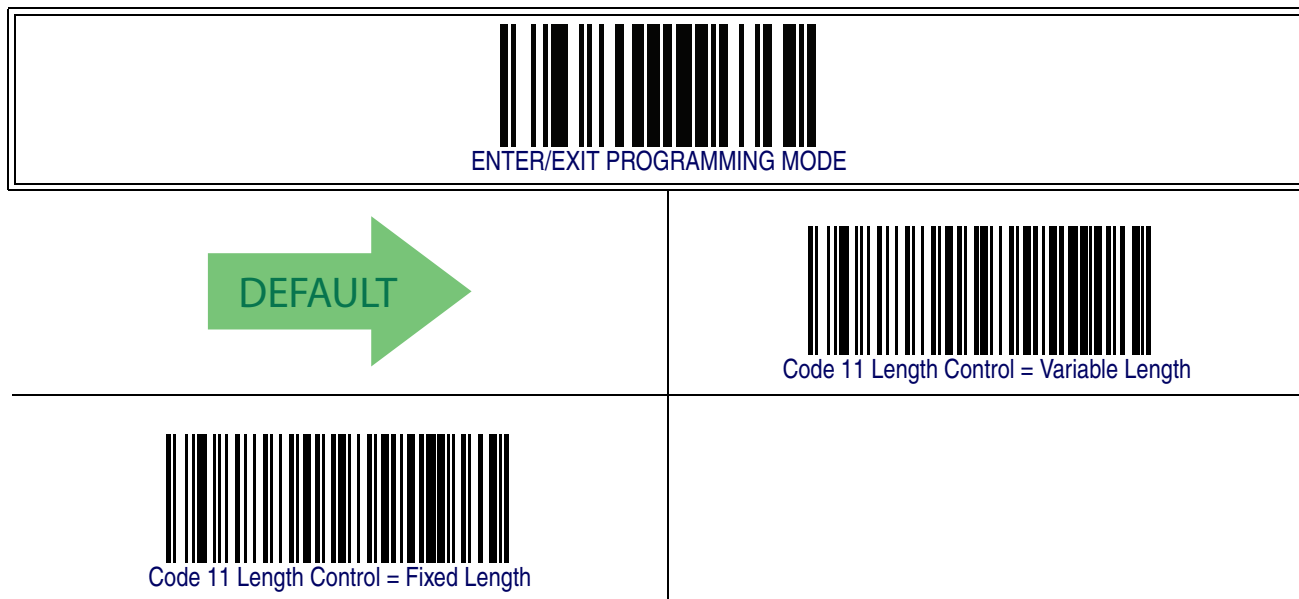

Code 11 – cont.

Code 11 Set Length 1

This feature specifies one of the barcode lengths for **Code 11 Length Control**. Length 1 is the minimum label length if in **Variable Length Mode**, or the first fixed length if in **Fixed Length Mode**. Length includes the barcode’s check and data characters. The length can be set from 2 to 50 characters.

Follow these instructions to set this feature:

1. Determine the desired character length (from 2 to 50). Pad the number with leading zeroes to yield two digits. For example: 0 = 00, 5 = 05, 20 = 20, etc.
2. Scan the ENTER/EXIT PROGRAMMING MODE barcode to enter Programming Mode.
3. Scan the barcode: SELECT CODE 11 LENGTH 1 SETTING.
4. Scan the appropriate two digits from the keypad in **Appendix E, Keypad**, that represent the length setting which was determined in the steps above. You will hear a two-beep indication after the last character.



If you make a mistake before the last character, scan the CANCEL barcode to abort and not save the entry string. You can then start again at the beginning.

NOTE

5. Scan the ENTER/EXIT PROGRAMMING MODE barcode to exit Programming Mode.

This completes the procedure. See **Table 31** for some examples of how to set this feature.

Table 31. Code 11 Length 1 Setting Examples

| STEP | ACTION | EXAMPLES | | | |
|------|---|---------------|---------------|---------------|---------------|
| 1 | Desired Setting (pad with leading zeroes) | 02 Characters | 07 Characters | 15 Characters | 50 Characters |
| 2 | Scan ENTER/EXIT PROGRAMMING MODE | | | | |
| 3 | Scan SELECT CODE 11 LENGTH 1 SETTING | | | | |
| 4 | Scan Two Characters From Appendix E, Keypad | '0' and '2' | '0' and '7' | '1' and '5' | '5' AND '0' |
| 5 | Scan ENTER/EXIT PROGRAMMING MODE | | | | |

Code 11 – cont.

Code 11 Set Length 1 – cont.

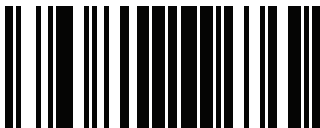
| |
|--|
|  ENTER/EXIT PROGRAMMING MODE |
|--|

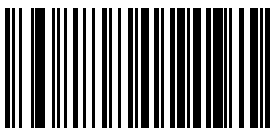
| | |
|--|--|
|  Select Code 11 Set Length 1 Setting | |
|--|--|

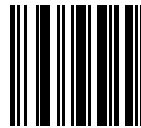
| | |
|--|---|
| Make a mistake? Scan the CANCEL barcode to abort and not save the entry string. You can then start again at the beginning. |  CANCEL |
|--|---|

 04 = Length 1 is 4 Characters

Code 11 – cont.

Code 11 Set Length 2

This feature specifies one of the barcode lengths for [Code 11 Length Control](#). Length 2 is the maximum label length if in [Variable Length Mode](#), or the second fixed length if in [Fixed Length Mode](#). Length includes the barcode's check and data characters.

The length can be set from 2 to 50 characters. A setting of 0 specifies to ignore this length (only one fixed length).

Follow these instructions to set this feature:

1. Determine the desired character length (from 2 to 50 — or 0 to ignore this length). Pad the number with leading zeroes to yield two digits. For example: 0 = 00, 5 = 05, 20 = 20, etc.
2. Scan the ENTER/EXIT PROGRAMMING MODE barcode to enter Programming Mode.
3. Scan the barcode: SELECT CODE 11 LENGTH 2 SETTING.
4. Scan the appropriate two digits from the keypad in [Appendix E, Keypad](#), that represent the length setting which was determined in the steps above. You will hear a two-beep indication after the last character.



If you make a mistake before the last character, scan the CANCEL barcode to abort and not save the entry string. You can then start again at the beginning.

NOTE

5. Scan the ENTER/EXIT PROGRAMMING MODE barcode to exit Programming Mode.

This completes the procedure. See [Table 32](#) for some examples of how to set this feature.

Table 32. Code 11 Length 2 Setting Examples

| STEP | ACTION | EXAMPLES | | | |
|------|---|-------------------------|---------------|---------------|---------------|
| 1 | Desired Setting (pad with leading zeroes) | 00 (Ignore This Length) | 07 Characters | 15 Characters | 50 Characters |
| 2 | Scan ENTER/EXIT PROGRAMMING MODE | | | | |
| 3 | Scan SELECT CODE 11 LENGTH 2 SETTING | | | | |
| 4 | Scan Two Characters From Appendix E, Keypad | '0' and '0' | '0' and '7' | '0' and 'F' | '3' AND 2' |
| 5 | Scan ENTER/EXIT PROGRAMMING MODE | | | | |

Code 11 – cont.

Code 11 Set Length 2 – cont.

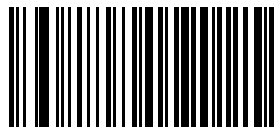
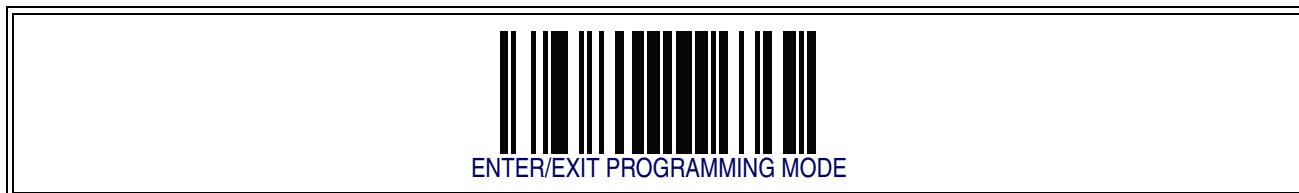

Select Code 11 Length 2 Setting

Make a mistake? Scan the CANCEL barcode to abort and not save the entry string. You can then start again at the beginning.

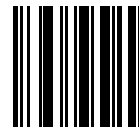

CANCEL

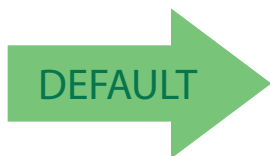

50 = Length 2 is 50 Characters

Code 11 – cont.



Code 11 Interdigit Ratio

This feature specifies the ratio between an intercharacter space and module for Code 11 labels.

| | |
|---|--|
|  ENTER/EXIT PROGRAMMING MODE | |
| |  Code 11 Interdigit Ratio = Disable |
|  Code 11 Interdigit Ratio = 1 | |
| |  Code 11 Interdigit Ratio = 2 |
|  Code 11 Interdigit Ratio = 3 | |
|  DEFAULT |  Code 11 Interdigit Ratio = 4 |
|  Code 11 Interdigit Ratio = 5 | |

Code 11 – cont.

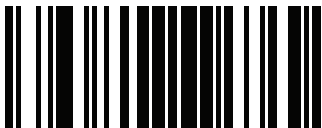
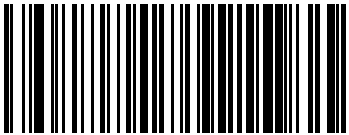
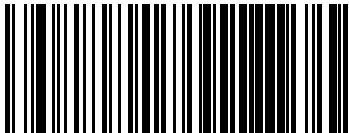
Code 11 Interdigit Ratio – cont.

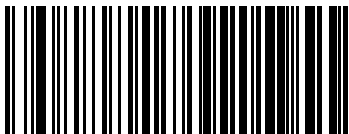
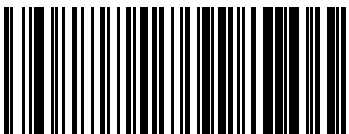
| | |
|---|---|
|  ENTER/EXIT PROGRAMMING MODE | |
| |  Code 11 Interdigit Ratio = 6 |
|  Code 11 Interdigit Ratio = 7 | |
| |  Code 11 Interdigit Ratio = 8 |
|  Code 11 Interdigit Ratio = 9 | |
| |  Code 11 Interdigit Ratio = 10 |

Code 11 Decoding Level

Decoding Levels are used to configure a barcode symbology decoder to be very aggressive to very conservative depending on a particular customer's needs.

- Choosing Level 1 results in a very conservative decoder at the expense of not being able to read poorly printed or damaged labels.
- Choosing Level 5 results in a very aggressive decoder. This aggressive behavior allows decoding of poorly printed and damaged labels at the expense of increasing the likelihood of decoding errors.
- Choosing Level 3, which is the default setting, allows the majority of product labels to be decoded.

There are many factors that determine when to change the decoding level for a particular symbology. These factors include spots, voids, non-uniform bar/space widths, damaged labels, etc. that may be experienced in some barcode labels. If there are many hard to read or damaged labels that cannot be decoded using a conservative setting, increase the decoding level to be more aggressive. If the majority of labels are very good quality labels, or there is a need to decrease the possibility of a decoder error, lower the decoding level to a more conservative level.

Code 11 – cont.

Code 11 Decoding Level – cont.

| | |
|---|--|
|  ENTER/EXIT PROGRAMMING MODE | |
|  Codabar Decoding Level = 1 | |
| |  Codabar Decoding Level = 2 |
|  Codabar Decoding Level = 3 |  |
| |  Codabar Decoding Level = 4 |
|  Codabar Decoding Level = 5 | |

Code 11 – cont.

Code 11 Character Correlation

When correlation is enabled, the barcode reader will combine label data from multiple scans when decoding. Enabling correlation will help the scanner read labels that have some spots and/or voids. It may also help read labels that have damaged areas. Enabling correlation will also increase the chances that a label will be read incorrectly.

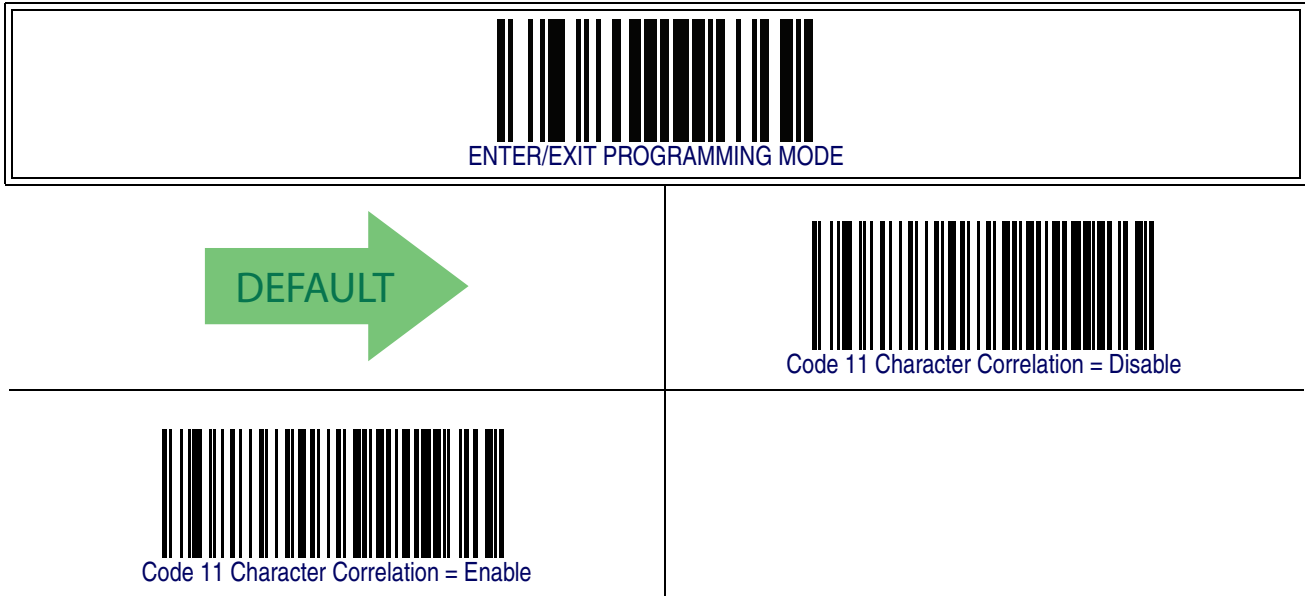

Code 11 Stitching

This option enables/disables stitching for Code 11 labels. When parts of a Code 11 barcode are presented to the reader with this feature enabled, the barcode parts will be assembled by the reader's software, and the data will be decoded if all barcode proofing requirements are met.

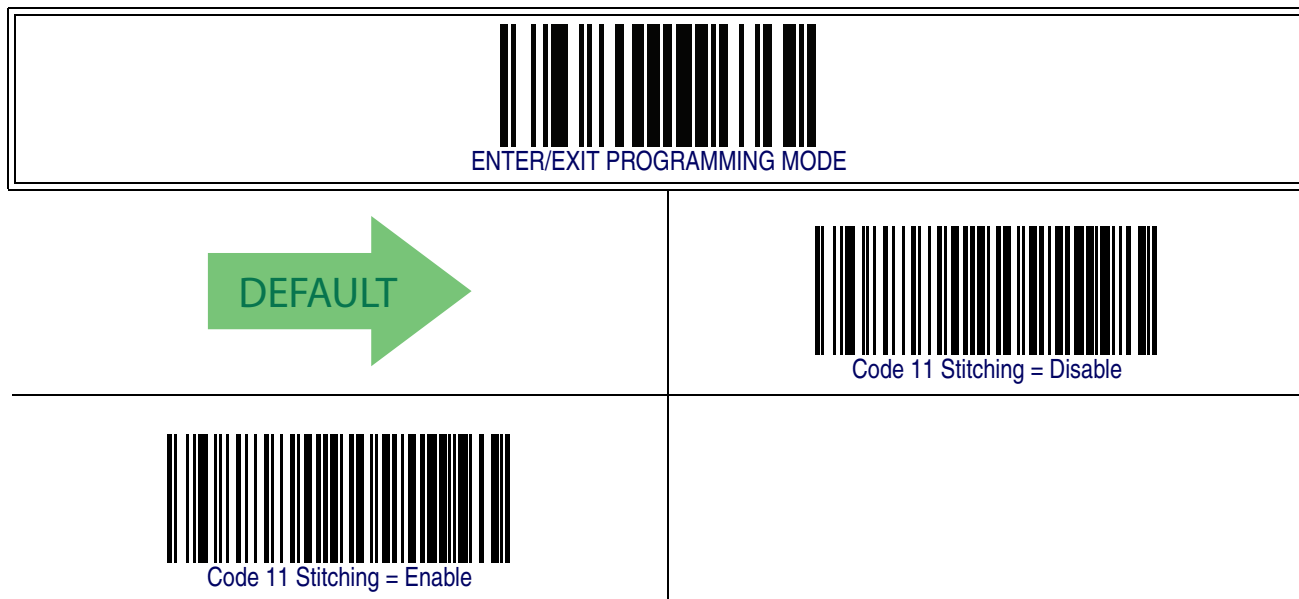

Standard 2 of 5

The following options apply to the Standard 2 of 5 symbology.

Standard 2 of 5 Enable/Disable

When disabled, the reader will not read Standard 2 of 5 barcodes.



Standard 2 of 5 — cont.

Standard 2 of 5 Check Character Calculation

This option enables/disables calculation and verification of an optional Standard 2 of 5 check character.

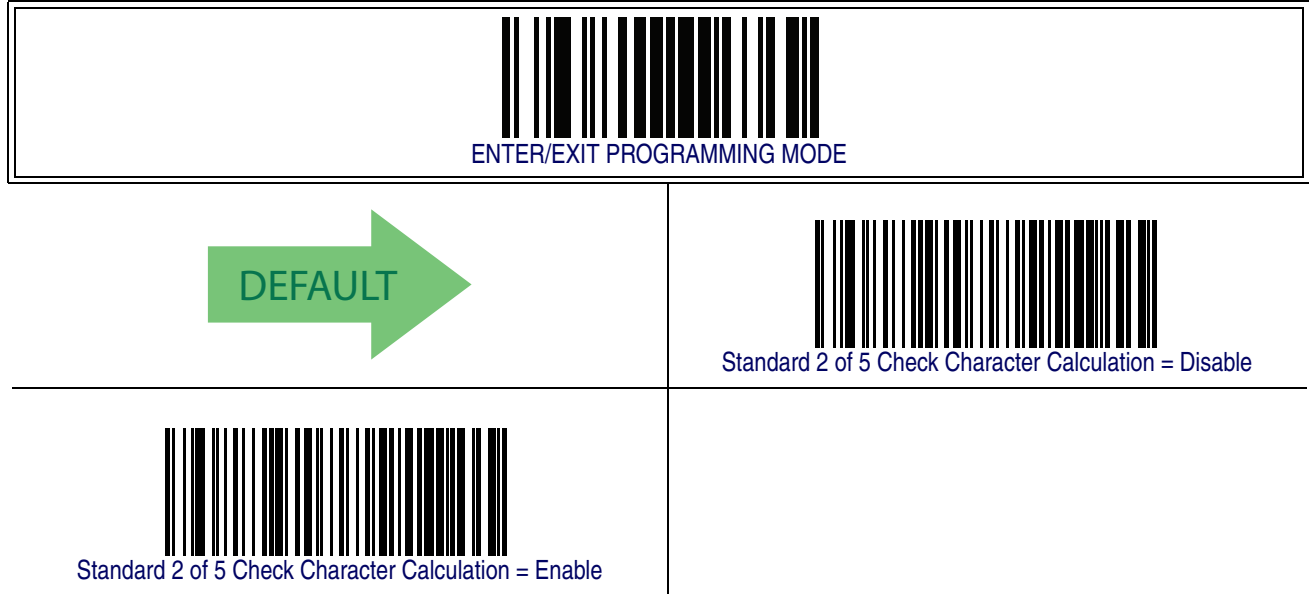

Standard 2 of 5 Check Character Transmission

This feature enables/disables transmission of an optional Standard 2 of 5 check character.



Standard 2 of 5 – cont.

Standard 2 of 5 Minimum Reads

This feature specifies the minimum number of consecutive times a Standard 2 of 5 label must be decoded before it is accepted as good read.

| | |
|--|---|
|  ENTER/EXIT PROGRAMMING MODE | |
|  |  Standard 2 of 5 Minimum Reads = 1 |
|  Standard 2 of 5 Minimum Reads = 2 | |
| |  Standard 2 of 5 Minimum Reads = 3 |
|  Standard 2 of 5 Minimum Reads = 4 | |

Standard 2 of 5 Decoding Level



NOTE

The Standard 2 of 5 Decoding Level feature is set using | 2 of 5 Decoding Level on page 211.

Standard 2 of 5 — cont.

Standard 2 of 5 Length Control

This feature specifies either variable length decoding or fixed length decoding for the Standard 2 of 5 symbology.

Variable Length — For variable length decoding, a minimum and maximum length may be set.

Fixed Length — For fixed length decoding, two different lengths may be set.



Standard 2 of 5 – cont.

Standard 2 of 5 Set Length 1

This feature specifies one of the barcode lengths for [Standard 2 of 5 Length Control](#). Length 1 is the minimum label length if in [Variable Length Mode](#), or the first fixed length if in [Fixed Length Mode](#). Length includes the barcode’s check and data characters.

The length can be set from 1 to 50 characters.

Follow these instructions to set this feature:

1. Determine the desired character length (from 1 to 50). Pad the number with leading zeroes to yield two digits. For example: 0 = 00, 5 = 05, 20 = 20, etc.
2. Scan the ENTER/EXIT PROGRAMMING MODE barcode to enter Programming Mode.
3. Scan the barcode: SELECT STANDARD 2 OF 5 LENGTH 1 SETTING.
4. Scan the appropriate two digits from the keypad in [Appendix E, Keypad](#), that represent the length setting which was determined in the steps above. You will hear a two-beep indication after the last character.



If you make a mistake before the last character, scan the CANCEL barcode to abort and not save the entry string. You can then start again at the beginning.

NOTE

5. Scan the ENTER/EXIT PROGRAMMING MODE barcode to exit Programming Mode.

This completes the procedure. See [Table 33](#) for some examples of how to set this feature.

Table 33. Standard 2 of 5 Length 1 Setting Examples

| STEP | ACTION | EXAMPLES | | | |
|------|---|--------------|---------------|---------------|---------------|
| | | 01 Character | 07 Characters | 15 Characters | 50 Characters |
| 1 | Desired Setting | 01 Character | 07 Characters | 15 Characters | 50 Characters |
| 2 | Scan ENTER/EXIT PROGRAMMING MODE | | | | |
| 3 | Scan SELECT STANDARD 2 OF 5 LENGTH 1 SETTING | | | | |
| 4 | Scan Two Characters From Appendix E, Keypad | '0' and '1' | '0' and '7' | '1' and '5' | '5' AND '0' |
| 5 | Scan ENTER/EXIT PROGRAMMING MODE | | | | |

Standard 2 of 5 — cont.

Standard 2 of 5 Set Length 1 — cont.

| |
|--|
|  ENTER/EXIT PROGRAMMING MODE |
|--|

| | |
|--|--|
|  Select Standard 2 of 5 Length 1 Setting | |
|--|--|

| | |
|--|---|
| Make a mistake? Scan the CANCEL barcode to abort and not save the entry string. You can then start again at the beginning. |  CANCEL |
|--|---|

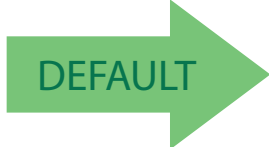
 08 = Length 1 is 8 Characters

Standard 2 of 5 — cont.

Standard 2 of 5 Set Length 2

This feature specifies one of the barcode lengths for [Standard 2 of 5 Length Control](#). Length 2 is the maximum label length if in [Variable Length Mode](#), or the second fixed length if in [Fixed Length Mode](#). Length includes the barcode's check and data characters.

The length can be set from 1 to 50 characters. A setting of 0 specifies to ignore this length (only one fixed length).

Follow these instructions to set this feature:

1. Determine the desired character length (from 1 to 50 — or 0 to ignore this length). Pad the number with leading zeroes to yield two digits. For example: 0 = 00, 5 = 05, 20 = 20, etc.
2. Scan the ENTER/EXIT PROGRAMMING MODE barcode to enter Programming Mode.
3. Scan the barcode: SELECT STANDARD 2 OF 5 LENGTH 2 SETTING.
4. Scan the appropriate two digits from the keypad in [Appendix E, Keypad](#), that represent the length setting which was determined in the steps above. You will hear a two-beep indication after the last character.



If you make a mistake before the last character, scan the CANCEL barcode to abort and not save the entry string. You can then start again at the beginning.

NOTE

5. Scan the ENTER/EXIT PROGRAMMING MODE barcode to exit Programming Mode.

This completes the procedure. See [Table 34](#) for some examples of how to set this feature.

Table 34. Standard 2 of 5 Length 2 Setting Examples

| STEP | ACTION | EXAMPLES | | | |
|------|---|-------------------------|---------------|---------------|---------------|
| 1 | Desired Setting (pad with leading zeroes) | 00 (Ignore This Length) | 07 Characters | 15 Characters | 50 Characters |
| 2 | Scan ENTER/EXIT PROGRAMMING MODE | | | | |
| 3 | Scan SELECT STANDARD 2 OF 5 LENGTH 2 SETTING | | | | |
| 4 | Scan Two Characters From Appendix E, Keypad | '0' and '0' | '0' and '7' | '1' and '5' | '5' AND '0' |
| 5 | Scan ENTER/EXIT PROGRAMMING MODE | | | | |

Standard 2 of 5 – cont.

Standard 2 of 5 Set Length 2 – cont.

| |
|--|
|  ENTER/EXIT PROGRAMMING MODE |
|--|

| | |
|--|--|
|  Select Standard 2 of 5 Length 2 Setting | |
|--|--|

| | |
|--|---|
| Make a mistake? Scan the CANCEL barcode to abort and not save the entry string. You can then start again at the beginning. |  CANCEL |
|--|---|

 50 = Length 2 is 50 Characters

Standard 2 of 5 – cont.

Standard 2 of 5 Character Correlation

When correlation is enabled, the barcode reader will combine label data from multiple scans when decoding. Enabling correlation will help the scanner read labels that have some spots and/or voids. It may also help read labels that have damaged areas. Enabling correlation will also increase the chances that a label will be read incorrectly.

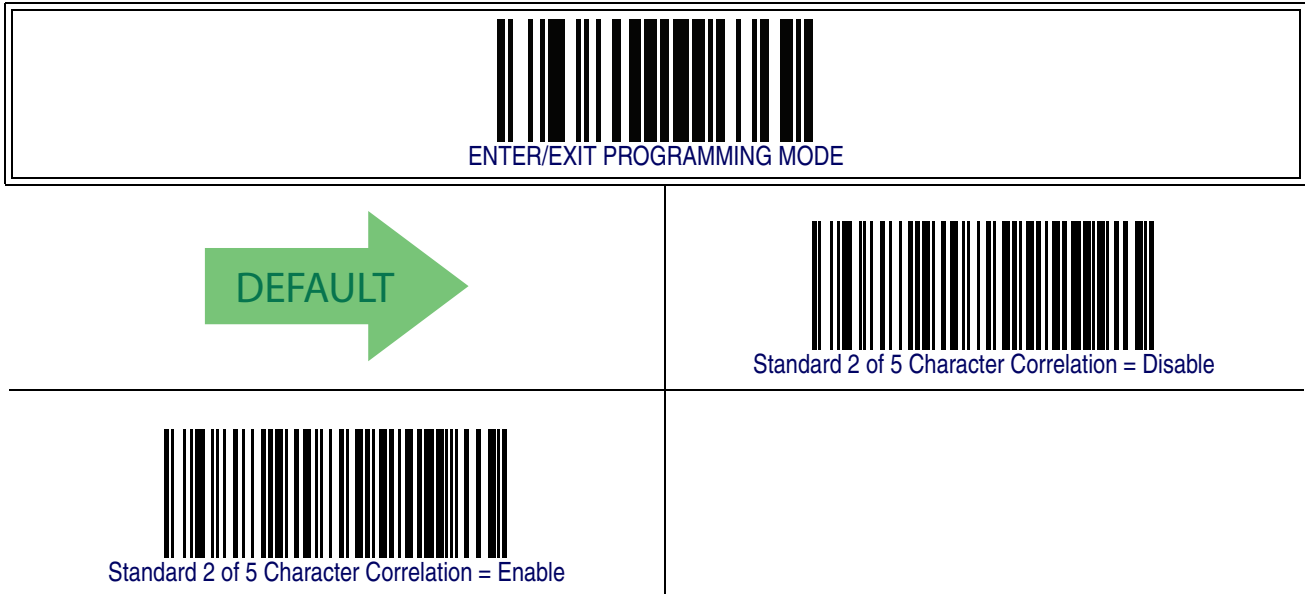

Standard 2 of 5 — cont.

Standard 2 of 5 Stitching

This option enables/disables stitching for Standard 2 of 5 labels. When parts of a Standard 2 of 5 barcode are presented to the reader with this feature enabled, the barcode parts will be assembled by the reader's software, and the data will be decoded if all barcode proofing requirements are met.



Industrial 2 of 5

The following options apply to the Industrial 2 of 5 symbology.

Industrial 2 of 5 Enable/Disable

Enables/Disables ability of reader to decode Industrial 2 of 5 labels.

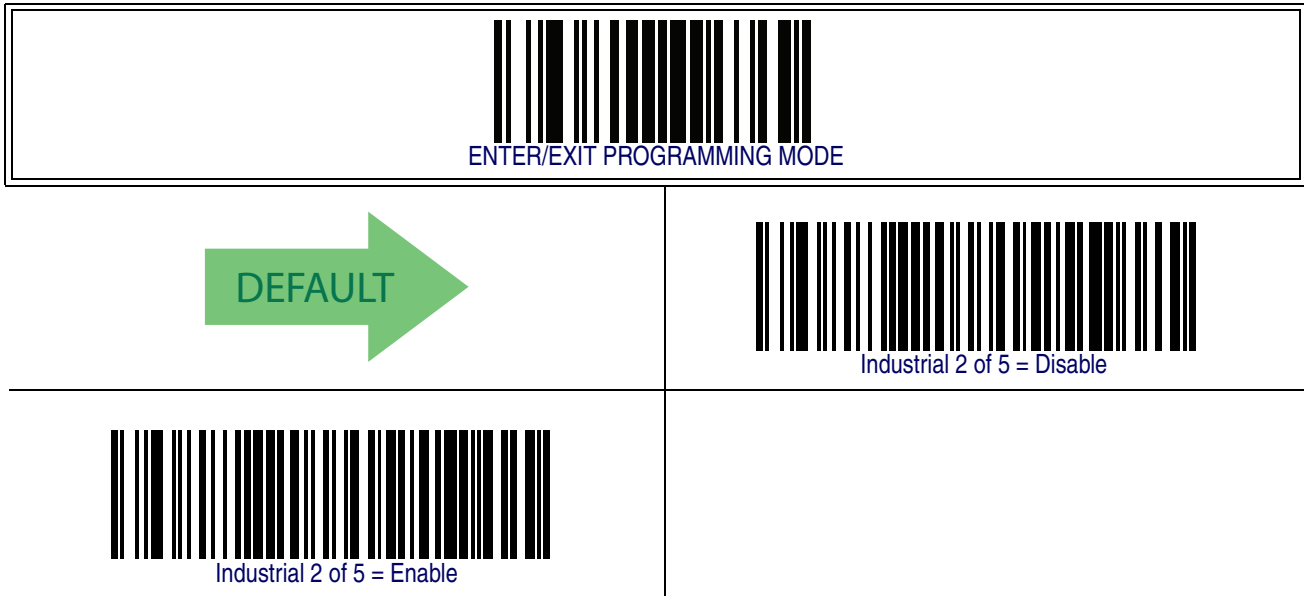

Industrial 2 of 5 Check Character Calculation

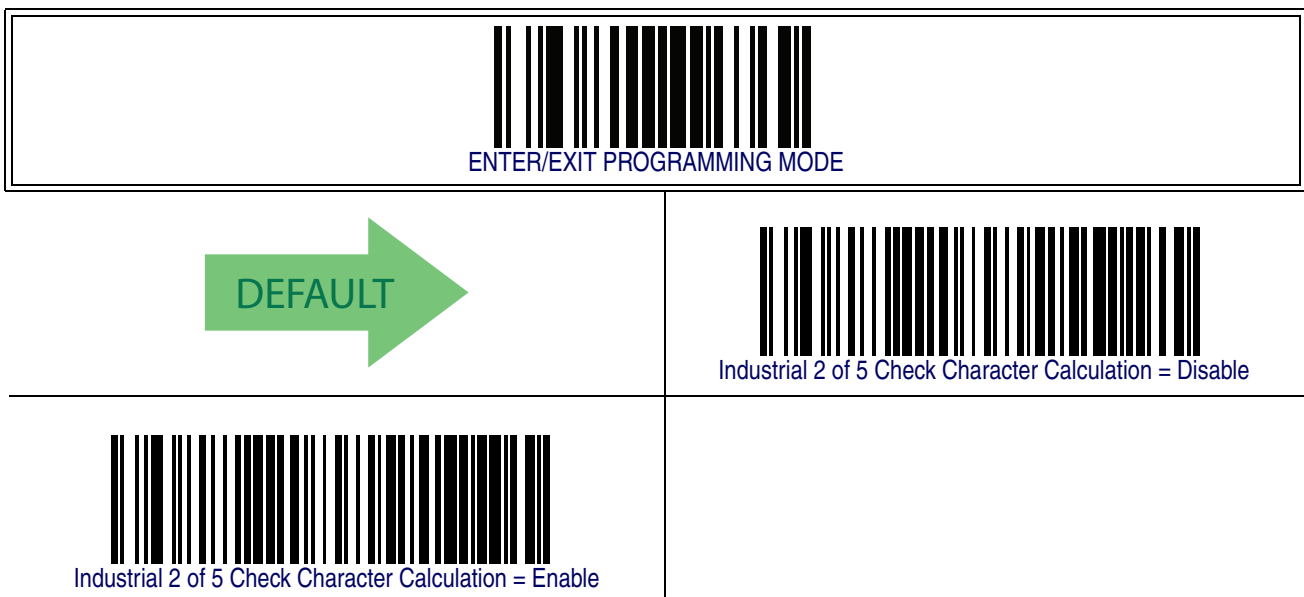

Enables/Disables calculation and verification of an optional Industrial 2 of 5 check character.



Industrial 2 of 5 – cont.

Industrial 2 of 5 Check Character Transmission

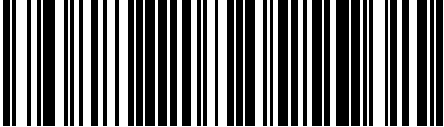
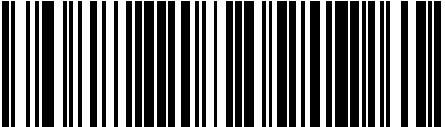
Enables/disables transmission of an Industrial 2 of 5 check character.

| | |
|--|--|
|  ENTER/EXIT PROGRAMMING MODE | |
| |  Industrial 2 of 5 Check Character Transmission = Disable |
|  Industrial 2 of 5 Check Character Transmission = Enable |  DEFAULT |

Industrial 2 of 5 – cont.

Industrial 2 of 5 Length Control

This feature specifies either variable length decoding or fixed length decoding for the Industrial 2 of 5 symbology.

Variable Length – For variable length decoding, a minimum and maximum length may be set.

Fixed Length – For fixed length decoding, two different lengths may be set.

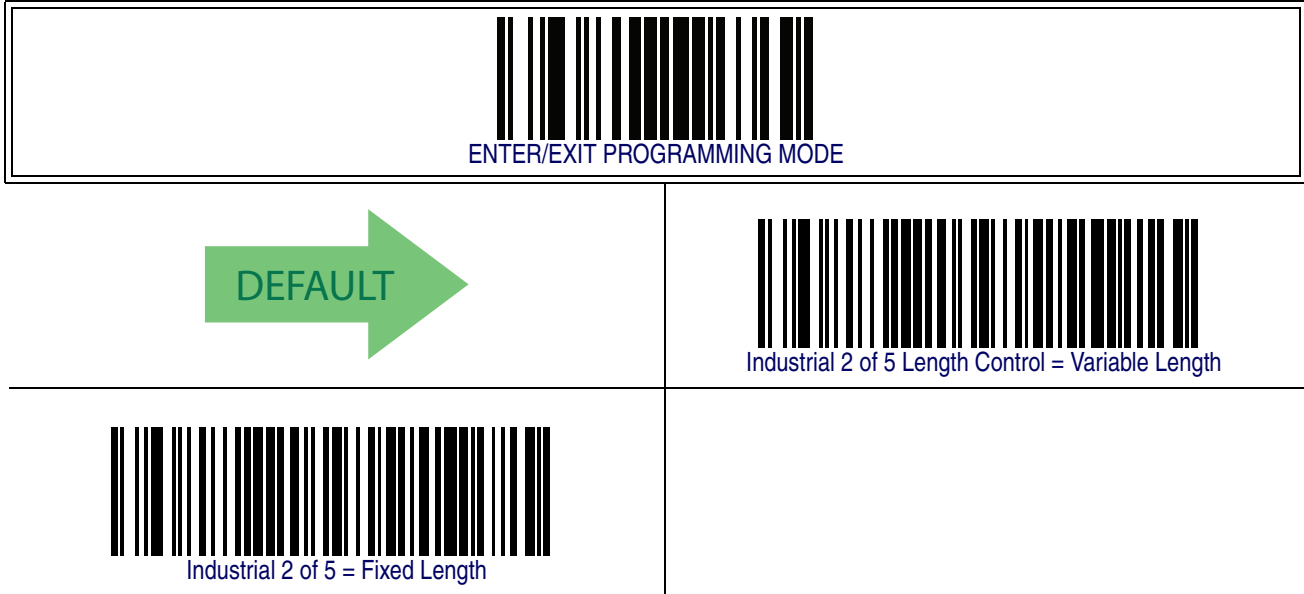

Industrial 2 of 5 – cont.

Industrial 2 of 5 Set Length 1

This feature specifies one of the barcode lengths for **Industrial 2 of 5 Length Control**. Length 1 is the minimum label length if in **Variable Length Mode**, or the first fixed length if in **Fixed Length Mode**. Length includes the barcode’s data characters only. The length can be set from 1 to 50 characters.

Follow these instructions to set this feature:

1. Determine the desired character length (from 1 to 50). Pad the number with leading zeroes to yield two digits. For example: 1 = 01, 5 = 05, 20 = 20, etc.
2. Scan the ENTER/EXIT PROGRAMMING MODE barcode to enter Programming Mode.
3. Scan the barcode: SELECT INDUSTRIAL 2 of 5 LENGTH 1 SETTING.
4. Scan the appropriate two digits from the keypad in the Keypad Appendix, that represent the length setting which was determined in the steps above. You will hear a two-beep indication after the last character.



If you make a mistake before the last character, scan the CANCEL barcode to abort and not save the entry string. You can then start again at the beginning.

NOTE

5. Scan the ENTER/EXIT PROGRAMMING MODE barcode to exit Programming Mode.

This completes the procedure. See the table below for some examples of how to set this feature.

Table 35. Code 39 Length 1 Setting Examples

| STEP | ACTION | EXAMPLES | | | |
|------|--|---------------|---------------|---------------|---------------|
| 1 | Desired Setting | 01 Characters | 07 Characters | 15 Characters | 50 Characters |
| 2 | Scan ENTER/EXIT PROGRAMMING MODE | | | | |
| 3 | Scan SELECT INDUSTRIAL 2 OF 5 LENGTH 1 SETTING | | | | |
| 4 | Scan Two Characters From the Keypad Appendix | '0' and '1' | '0' and '7' | '1' and '5' | '5' AND '0' |
| 5 | Scan ENTER/EXIT PROGRAMMING MODE | | | | |

Industrial 2 of 5 – cont.

Industrial 2 of 5 Set Length 1 – cont.

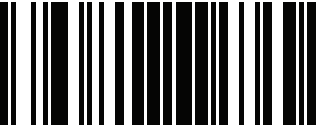
| |
|--|
|  ENTER/EXIT PROGRAMMING MODE |
|--|

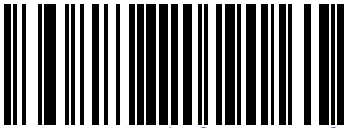
| | |
|--|--|
|  Select Industrial 2 of 5 Set Length 1 Setting | |
|--|--|

| | |
|--|---|
| Make a mistake? Scan the CANCEL barcode to abort and not save the entry string. You can then start again at the beginning. |  CANCEL |
|--|---|

 01 = Length 1 is 1 Character

Industrial 2 of 5 – cont.

Industrial 2 of 5 Set Length 2

This feature specifies one of the barcode lengths for **Industrial 2 of 5 Length Control**. Length 2 is the maximum label length if in **Variable Length Mode**, or the second fixed length if in **Fixed Length Mode**. Length includes the barcode’s check, data, and full-ASCII shift characters. The length does not include start/stop characters.

The length can be set from 1 to 50 characters. A setting of 0 specifies to ignore this length (only one fixed length).

Follow these instructions to set this feature:

1. Determine the desired character length (from 1 to 50 — or 0 to ignore this length). Pad the number with leading zeroes to yield two digits. For example: 0 = 00, 5 = 05, 20 = 20, etc.
2. Scan the ENTER/EXIT PROGRAMMING MODE barcode to enter Programming Mode.
3. Scan the barcode: SELECT INDUSTRIAL 2 OF 5 LENGTH 2 SETTING.
4. Scan the appropriate two digits from the keypad in the Keypad Appendix that represent the length setting which was determined in the steps above. You will hear a two-beep indication after the last character.



If you make a mistake, before the last character scan the CANCEL barcode to abort and not save the entry string. You can then start again at the beginning.

NOTE

5. Scan the ENTER/EXIT PROGRAMMING MODE barcode to exit Programming Mode.

This completes the procedure. See the table below for some examples of how to set this feature.

Table 36. Code 39 Length 2 Setting Examples

| STEP | ACTION | EXAMPLES | | | |
|------|--|-------------------------|---------------|---------------|---------------|
| 1 | Desired Setting | 00 (Ignore This Length) | 07 Characters | 15 Characters | 50 Characters |
| 2 | Scan ENTER/EXIT PROGRAMMING MODE | | | | |
| 3 | Scan SELECT INDUSTRIAL 2 OF 5 LENGTH 2 SETTING | | | | |
| 4 | Scan Two Characters From the Keypad Appendix | '0' and '0' | '0' and '7' | '1' and '5' | '5' AND '0' |
| 5 | Scan ENTER/EXIT PROGRAMMING MODE | | | | |

Industrial 2 of 5 – cont.

Industrial 2 of 5 Set Length 2 – cont.

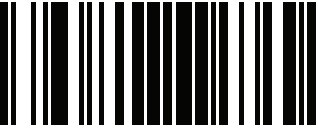
| |
|--|
|  ENTER/EXIT PROGRAMMING MODE |
|--|

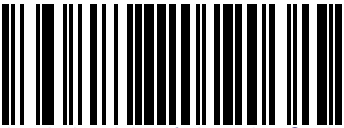
| | |
|--|--|
|  Select Industrial 2 of 5 Length 2 Setting | |
|--|--|

| | |
|--|---|
| Make a mistake? Scan the CANCEL barcode to abort and not save the entry string. You can then start again at the beginning. |  CANCEL |
|--|---|

 50 = Length 2 is 50 Characters

Industrial 2 of 5 – cont.

Industrial 2 of 5 Minimum Reads

This feature specifies the minimum number of consecutive times an Industrial 2 of 5 label must be decoded before it is accepted as good read..



Industrial 2 of 5 – cont.

Industrial 2 of 5 Stitching

Enables/disables fixed length stitching for Industrial 2 of 5.



Industrial 2 of 5 Character Correlation

Enable/disables character correlation for Industrial 2 of 5.

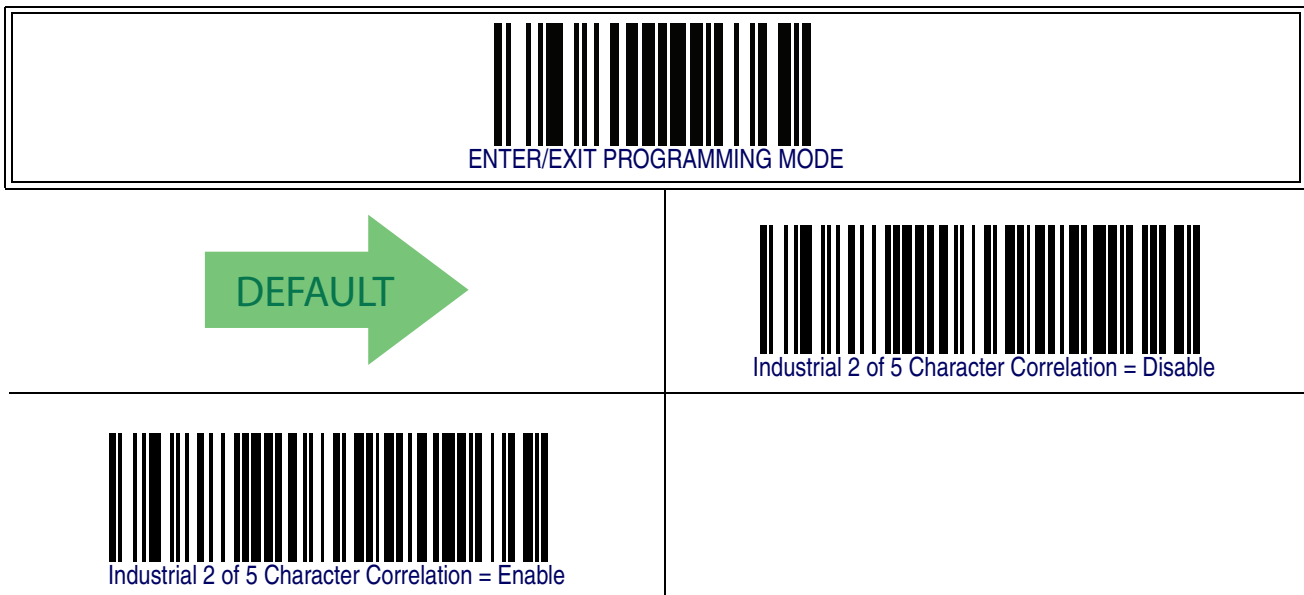

IATA

The following options apply to the IATA symbology.

IATA Enable/Disable

Enables/Disables the ability of the reader to decode IATA labels.

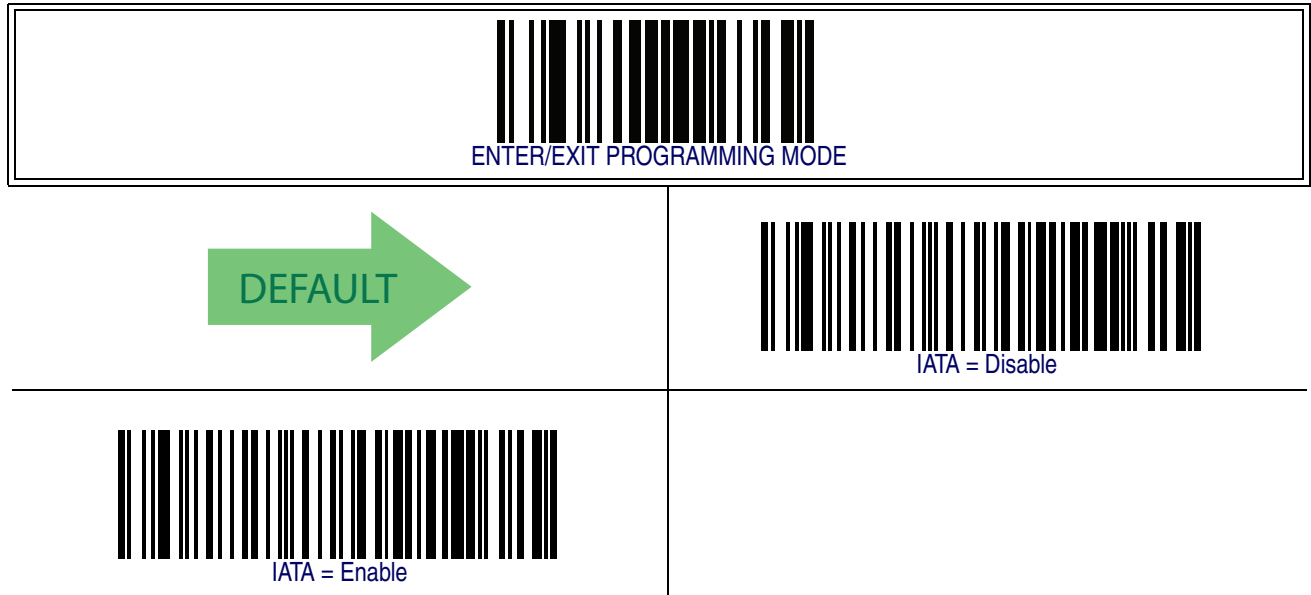

IATA Check Character Transmission

Enables/Disables calculation and verification of an optional Industrial 2 of 5 check character.



ISBT 128

The following options apply to the ISBT 128 symbology.

ISBT 128 Concatenation

Use this option to enable/disable ISBT128 concatenation of 2 labels.

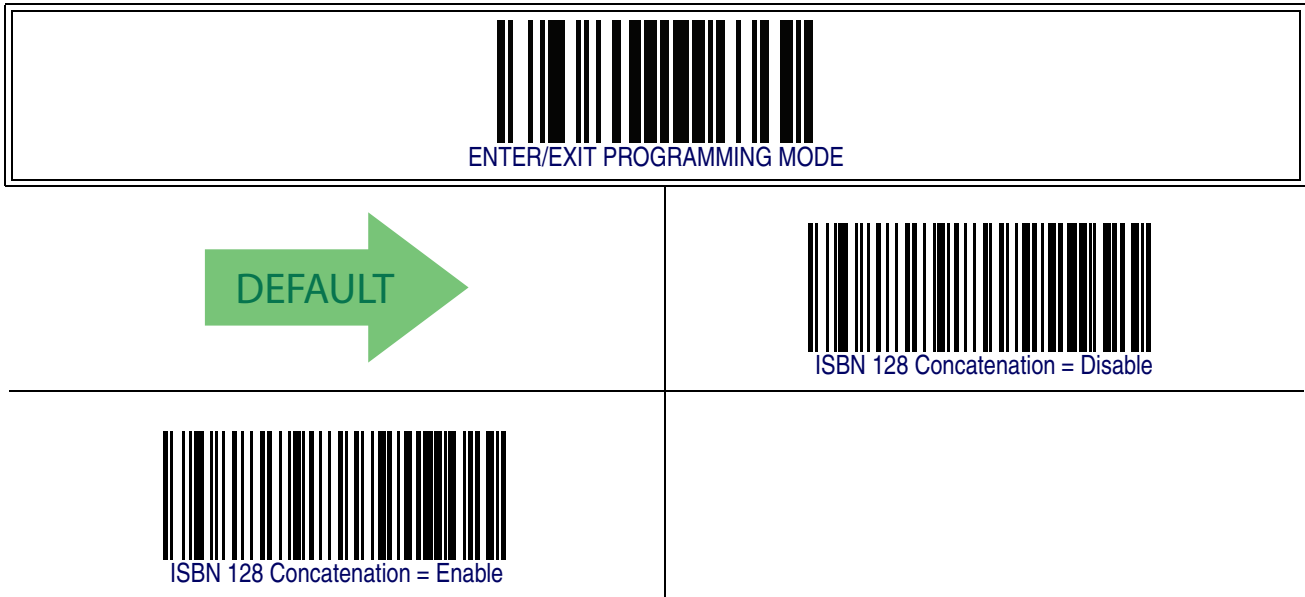

ISBT 128 Concatenation Mode

Specifies the concatenation mode between Static and Dynamic.



This option is only valid when ISBT 128 Concatenation is enabled (see page 288).





NOTE

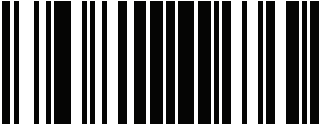
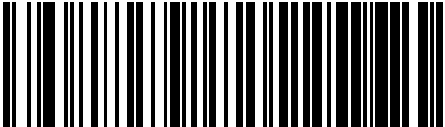

ISBT 128 – cont.

ISBT 128 Dynamic Concatenation Timeout

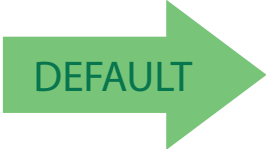
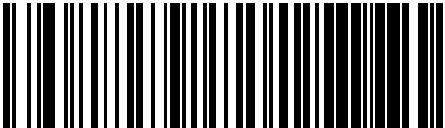
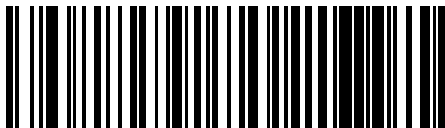
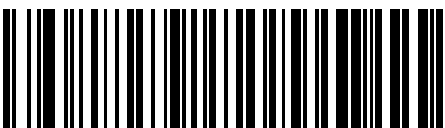
Specifies the timeout used by the ISBT 128 Dynamic Concatenation Mode.

| | |
|--|---|
|  ENTER/EXIT PROGRAMMING MODE | |
| |  ISBT 128 Dynamic Concatenation Timeout = 50 msec |
|  ISBT 128 Dynamic Concatenation Timeout = 100 msec | |
|  DEFAULT |  ISBT 128 Dynamic Concatenation Timeout = 200 msec |
|  ISBT 128 Dynamic Concatenation Timeout = 500 msec | |
| |  ISBT 128 Dynamic Concatenation Timeout = 750 msec |
|  ISBT 128 Dynamic Concatenation Timeout = 1 second | |

ISBT 128 – cont.

ISBT 128 Force Concatenation

When enabled, this feature forces concatenation for ISBT.



This option is only valid when ISBT 128 Concatenation is enabled. (see page 288).

NOTE



ISBT 128 Advanced Concatenation Options



Use the Datalogic Aladdin Configuration Application or contact Customer Support to set up pairs of label types for concatenation.

NOTE

MSI

The following options apply to the MSI symbology.

MSI Enable/Disable

Enables/Disables ability of reader to decode MSI labels.



MSI – cont.

MSI Check Character Calculation

Enables/Disables calculation and verification of an optional MSI check character.

| | |
|--|---|
|  ENTER/EXIT PROGRAMMING MODE | |
| |  MSI Check Character Calculation = Disable |
|  MSI Check Character Calculation = Enable Mod10 |  |
| |  MSI Check Character Calculation = Enable Mod11/10 |
|  MSI Check Character Calculation = Enable Mod10/10 | |

MSI – cont.

MSI Check Character Transmission

Enables/disables transmission of an MSI check character.

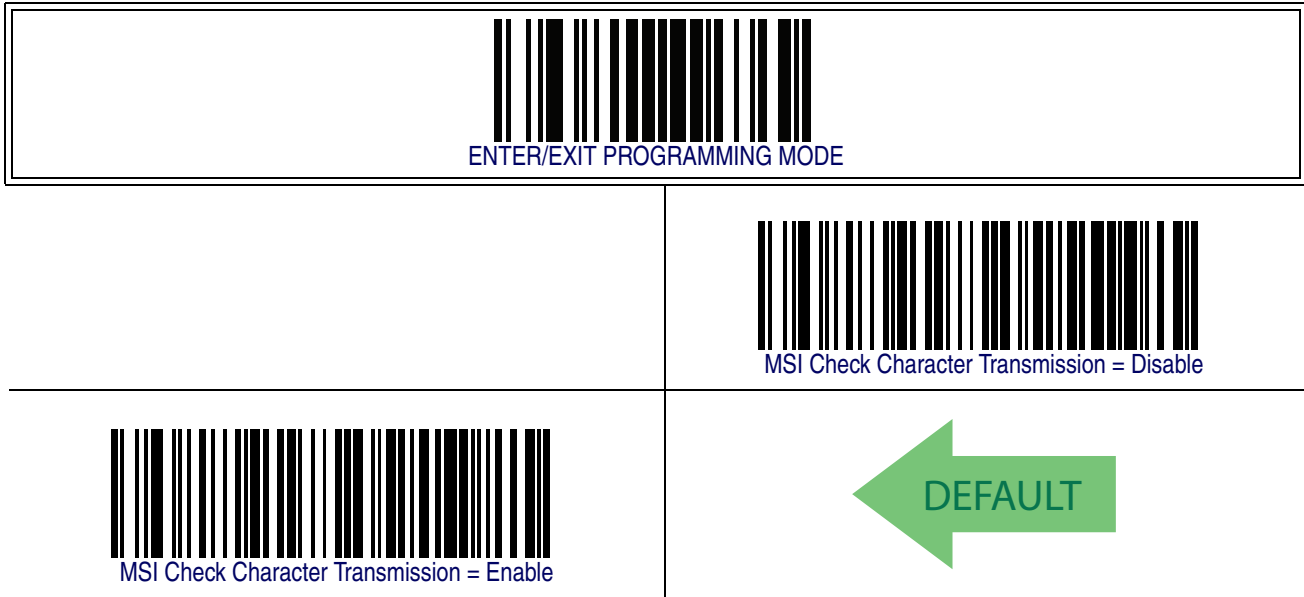

MSI Length Control

This feature specifies either variable length decoding or fixed length decoding for the MSI symbology.

Variable Length – For variable length decoding, a minimum and maximum length may be set.

Fixed Length – For fixed length decoding, two different lengths may be set.

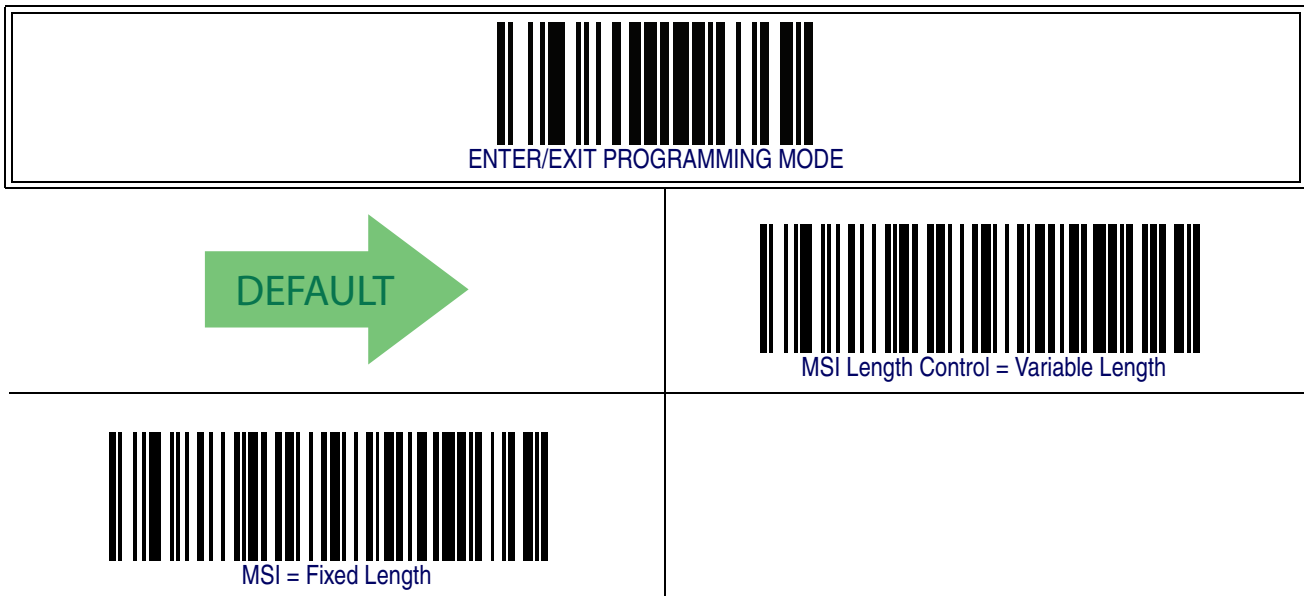

MSI – cont.

MSI Set Length 1

This feature specifies one of the barcode lengths for **MSI Length Control**. Length 1 is the minimum label length if in **Variable Length Mode**, or the first fixed length if in **Fixed Length Mode**. Length includes the barcode's data characters only.

The length can be set from 01 to 50 characters.

Follow these instructions to set this feature:

1. Determine the desired character length (from 0 to 50). Pad the number with leading zeroes to yield two digits. For example: 1 = 01, 5 = 05, 20 = 20, etc.
2. Scan the ENTER/EXIT PROGRAMMING MODE barcode to enter Programming Mode.
3. Scan the barcode: SELECT MSI LENGTH 1 SETTING.
4. Scan the appropriate two digits from the keypad in the Keypad Appendix, that represent the length setting which was determined in the steps above. You will hear a two-beep indication after the last character.



If you make a mistake before the last character, scan the CANCEL barcode to abort and not save the entry string. You can then start again at the beginning.

NOTE

5. Scan the ENTER/EXIT PROGRAMMING MODE barcode to exit Programming Mode.

This completes the procedure. See the table below for some examples of how to set this feature.

Table 37. MSI Length 1 Setting Examples

| STEP | ACTION | EXAMPLES | | | |
|------|--|---------------|---------------|---------------|---------------|
| 1 | Desired Setting | 01 Characters | 07 Characters | 15 Characters | 50 Characters |
| 2 | Scan ENTER/EXIT PROGRAMMING MODE | | | | |
| 3 | Scan SELECT MSI LENGTH 1 SETTING | | | | |
| 4 | Scan Two Characters From the Keypad Appendix | '0' and '1' | '0' and '7' | '1' and '5' | '5' AND '0' |
| 5 | Scan ENTER/EXIT PROGRAMMING MODE | | | | |

MSI — cont.

MSI Set Length 1 — cont.

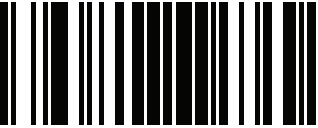
| |
|--|
|  ENTER/EXIT PROGRAMMING MODE |
|--|

| |
|--|
|  Select MSI Set Length 1 Setting |
|--|

Make a mistake? Scan the CANCEL barcode to abort and not save the entry string. You can then start again at the beginning.

| |
|---|
|  CANCEL |
|---|

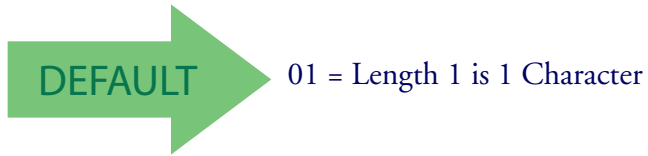

MSI – cont.

MSI Set Length 2

This feature specifies one of the barcode lengths for **MSI Length Control**. Length 2 is the maximum label length if in **Variable Length Mode**, or the second fixed length if in **Fixed Length Mode**. Length includes the barcode's check, data, and full-ASCII shift characters. The length does not include start/stop characters.

The length can be set from 1 to 50 characters. A setting of 0 specifies to ignore this length (only one fixed length).

Follow these instructions to set this feature:

1. Determine the desired character length (from 1 to 50 — or 0 to ignore this length). Pad the number with leading zeroes to yield two digits. For example: 0 = 00, 5 = 05, 20 = 20, etc.
2. Scan the ENTER/EXIT PROGRAMMING MODE barcode to enter Programming Mode.
3. Scan the barcode: SELECT MSI LENGTH 2 SETTING.
4. Scan the appropriate two digits from the keypad in the Keypad Appendix that represent the length setting which was determined in the steps above. You will hear a two-beep indication after the last character.



If you make a mistake, before the last character scan the CANCEL barcode to abort and not save the entry string. You can then start again at the beginning.

NOTE

5. Scan the ENTER/EXIT PROGRAMMING MODE barcode to exit Programming Mode.

This completes the procedure. See the table below for some examples of how to set this feature.

Table 38. MSI Length 2 Setting Examples

| STEP | ACTION | EXAMPLES | | | |
|------|--|-------------------------|---------------|---------------|---------------|
| 1 | Desired Setting | 00 (Ignore This Length) | 07 Characters | 15 Characters | 50 Characters |
| 2 | Scan ENTER/EXIT PROGRAMMING MODE | | | | |
| 3 | Scan SELECT MSI LENGTH 2 SETTING | | | | |
| 4 | Scan Two Characters From the Keypad Appendix | '0' and '0' | '0' and '7' | '1' and '5' | '5' AND '0' |
| 5 | Scan ENTER/EXIT PROGRAMMING MODE | | | | |

MSI — cont.

MSI Set Length 2 — cont.

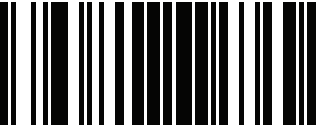
| |
|--|
|  ENTER/EXIT PROGRAMMING MODE |
|--|

| |
|--|
|  Select MSI Length 2 Setting |
|--|

Make a mistake? Scan the CANCEL barcode to abort and not save the entry string. You can then start again at the beginning.



| |
|---|
|  CANCEL |
|---|



MSI – cont.

MSI Minimum Reads

This feature specifies the minimum number of consecutive times an MSI label must be decoded before it is accepted as good read.

| | |
|--|---|
|  ENTER/EXIT PROGRAMMING MODE | |
| |  MSI Minimum Reads = 1 |
|  MSI Minimum Reads = 2 | |
| |  MSI Minimum Reads = 3 |
|  MSI Minimum Reads = 4 |  DEFAULT |

MSI – cont.

MSI Decoding Level

Decoding Levels are used to configure a barcode symbology decoder to be very aggressive to very conservative depending on a particular customer’s needs.

- Choosing Level 1 results in a very conservative decoder at the expense of not being able to read poorly printed or damaged labels.
- Choosing Level 5 results in a very aggressive decoder. This aggressive behavior allows decoding of poorly printed and damaged labels at the expense of increasing the likelihood of decoding errors.
- Choosing Level 3, which is the default setting, allows the majority of product labels to be decoded.

There are many factors that determine when to change the decoding level for a particular symbology. These factors include spots, voids, non-uniform bar/space widths, damaged labels, etc. that may be experienced in some barcode labels. If there are many hard to read or damaged labels that cannot be decoded using a conservative setting, increase the decoding level to be more aggressive. If the majority of labels are very good quality labels, or there is a need to decrease the possibility of a decoder error, lower the decoding level to a more conservative level.

| | |
|---|--|
|  ENTER/EXIT PROGRAMMING MODE | |
| |  MSI Decoding Level = Disable |
|  MSI Decoding Level = 1 | |
| |  MSI Decoding Level = 2 |

MSI – cont.

MSI Decoding Level – cont.

| | |
|---|--|
|  <p>MSI Decoding Level = 3</p> |  |
| |  <p>MSI Decoding Level = 4</p> |
|  <p>MSI Decoding Level = 5</p> | |

Plessey

The following options apply to the Plessey symbology.

Plessey Enable/Disable

Enables/Disables ability of reader to decode Plessey labels.

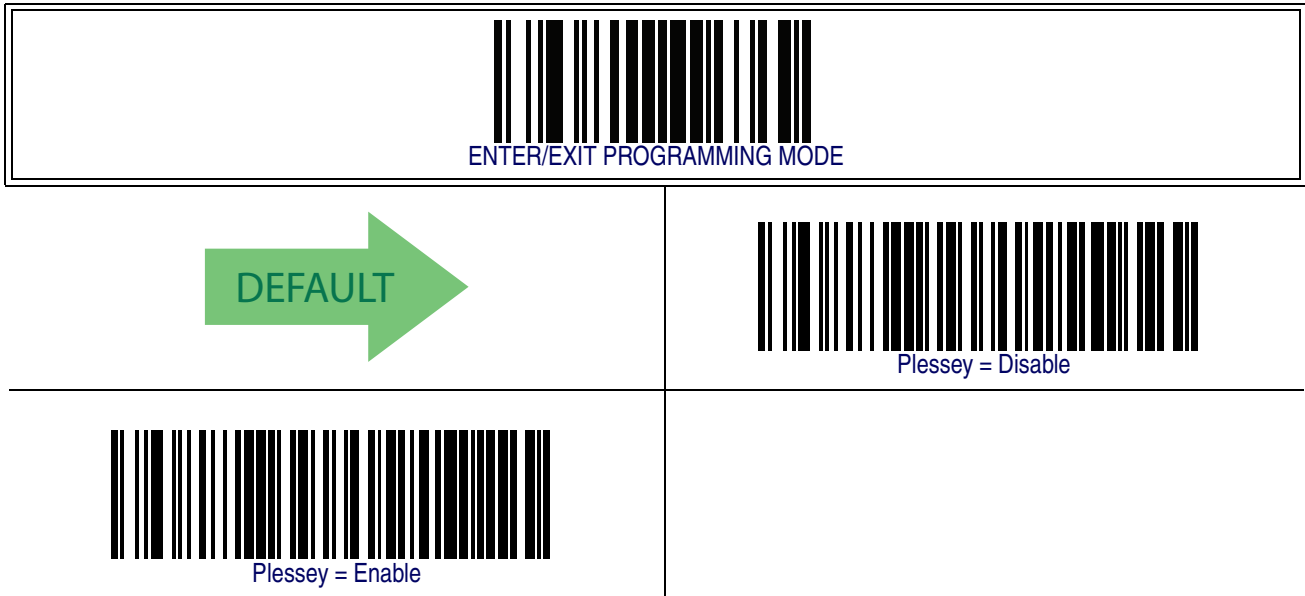

Plessey – cont.

Plessey Check Character Calculation

Enables/Disables calculation and verification of an optional Plessey check character.

| | |
|---|--|
|  ENTER/EXIT PROGRAMMING MODE | |
| |  Plessey Check Character Calculation = Disable |
|  Plessey Check Character Calculation = Enable Plessey std. check char. verification |  |
| |  Plessey Check Character Calculation = Enable Anker check char. verification |
|  Plessey Check Character Calculation = Enable Plessey std. and Anker check char verification | |

Plessey – cont.

Plessey Check Character Transmission

Enables/disables transmission of an MSI check character.

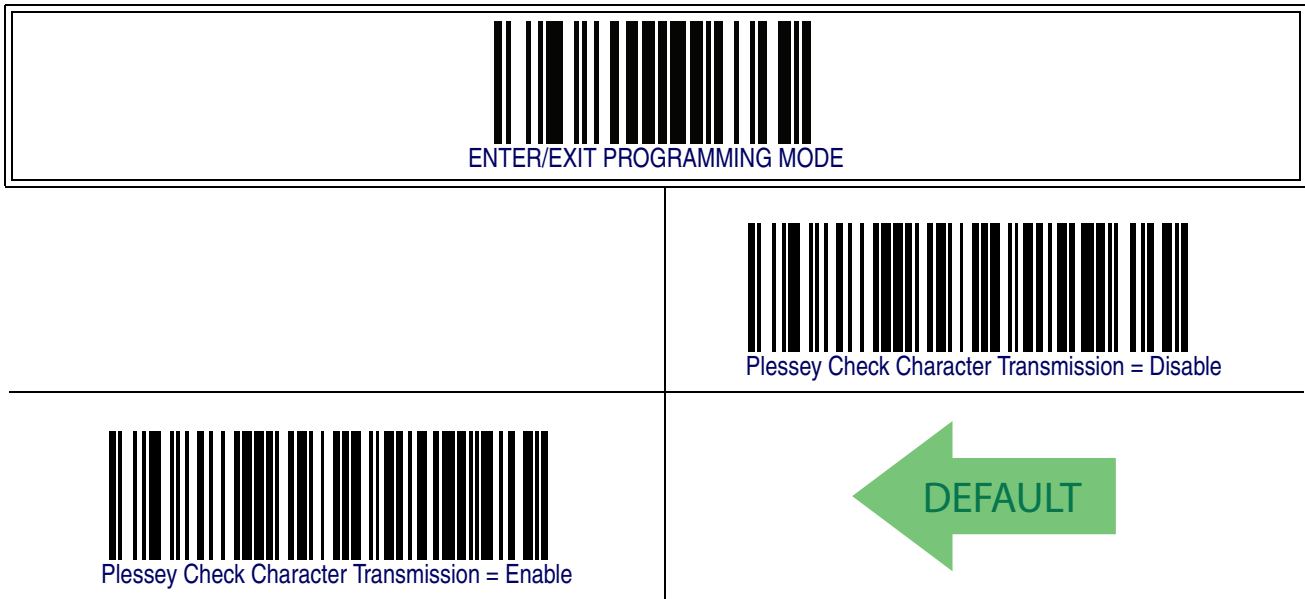

Plessey Length Control

This feature specifies either variable length decoding or fixed length decoding for the Plessey symbology.

Variable Length – For variable length decoding, a minimum and maximum length may be set.

Fixed Length – For fixed length decoding, two different lengths may be set.

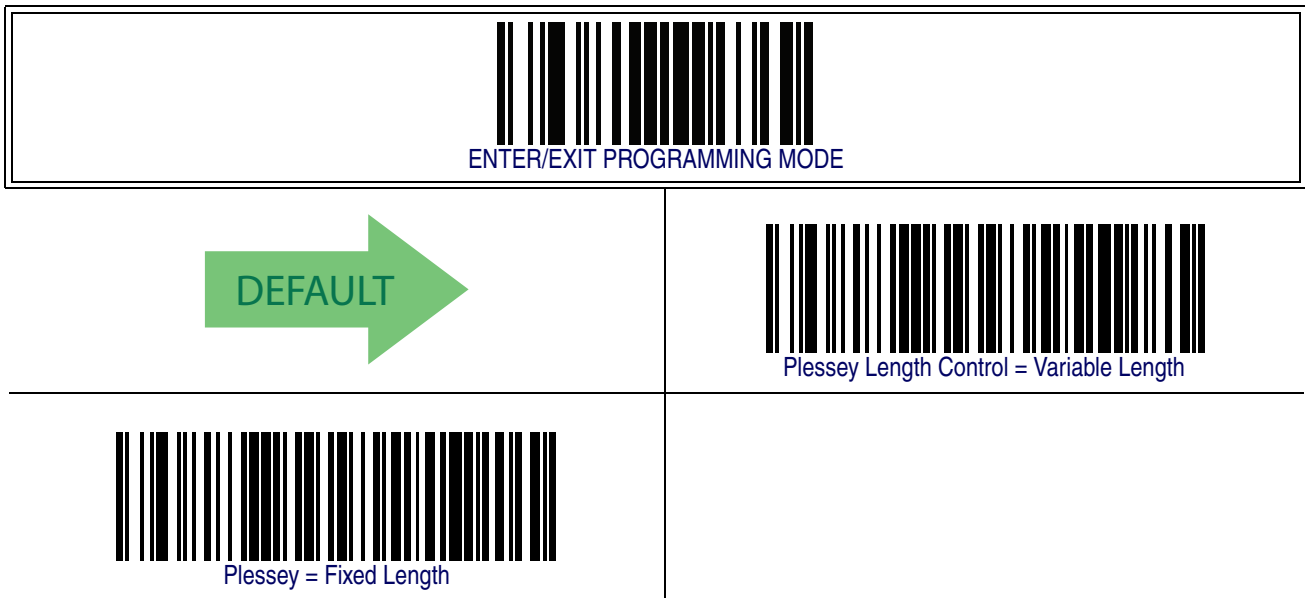

Plessey – cont.

Plessey Set Length 1

This feature specifies one of the barcode lengths for **Plessey Length Control**. Length 1 is the minimum label length if in **Variable Length Mode**, or the first fixed length if in **Fixed Length Mode**. Length includes the barcode's data characters only.

The length can be set from 01 to 50 characters.

Follow these instructions to set this feature:

1. Determine the desired character length (from 0 to 50). Pad the number with leading zeroes to yield two digits. For example: 1 = 01, 5 = 05, 20 = 20, etc.
2. Scan the ENTER/EXIT PROGRAMMING MODE barcode to enter Programming Mode.
3. Scan the barcode: SELECT PLESSEY LENGTH 1 SETTING.
4. Scan the appropriate two digits from the keypad in the Keypad Appendix, that represent the length setting which was determined in the steps above. You will hear a two-beep indication after the last character.



If you make a mistake before the last character, scan the CANCEL barcode to abort and not save the entry string. You can then start again at the beginning.

NOTE

5. Scan the ENTER/EXIT PROGRAMMING MODE barcode to exit Programming Mode.

This completes the procedure. See the table below for some examples of how to set this feature.

Table 39. Plessey Length 1 Setting Examples

| STEP | ACTION | EXAMPLES | | | |
|------|--|---------------|---------------|---------------|---------------|
| 1 | Desired Setting | 01 Characters | 07 Characters | 15 Characters | 50 Characters |
| 2 | Scan ENTER/EXIT PROGRAMMING MODE | | | | |
| 3 | Scan SELECT Plessey LENGTH 1 SETTING | | | | |
| 4 | Scan Two Characters From the Keypad Appendix | '0' and '1' | '0' and '7' | '1' and '5' | '5' AND '0' |
| 5 | Scan ENTER/EXIT PROGRAMMING MODE | | | | |

Plessey – cont.

Plessey Set Length 1 – cont.

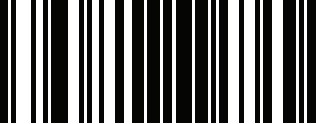
| |
|--|
|  ENTER/EXIT PROGRAMMING MODE |
|--|

| |
|--|
|  Select Plessey Set Length 1 Setting |
|--|

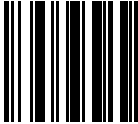
| | |
|---|---|
| <p>Make a mistake? Scan the CANCEL barcode to abort and not save the entry string. You can then start again at the beginning.</p> |  CANCEL |
|---|---|

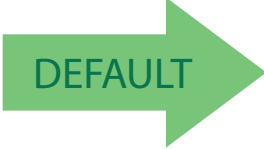
 01 = Length 1 is 1 Character

Plessey – cont.

Plessey Set Length 2

This feature specifies one of the barcode lengths for **Plessey Length Control**. Length 2 is the maximum label length if in **Variable Length Mode**, or the second fixed length if in **Fixed Length Mode**. Length includes the barcode's check, data, and full-ASCII shift characters. The length does not include start/stop characters.

The length can be set from 1 to 50 characters. A setting of 0 specifies to ignore this length (only one fixed length).

Follow these instructions to set this feature:

1. Determine the desired character length (from 1 to 50 — or 0 to ignore this length). Pad the number with leading zeroes to yield two digits. For example: 0 = 00, 5 = 05, 20 = 20, etc.
2. Scan the ENTER/EXIT PROGRAMMING MODE barcode to enter Programming Mode.
3. Scan the barcode: SELECT PLESSEY LENGTH 2 SETTING.
4. Scan the appropriate two digits from the keypad in the Keypad Appendix that represent the length setting which was determined in the steps above. You will hear a two-beep indication after the last character.



If you make a mistake, before the last character scan the CANCEL barcode to abort and not save the entry string. You can then start again at the beginning.

NOTE

5. Scan the ENTER/EXIT PROGRAMMING MODE barcode to exit Programming Mode.

This completes the procedure. See the table below for some examples of how to set this feature.

Table 40. Plessey Length 2 Setting Examples

| STEP | ACTION | EXAMPLES | | | |
|------|--|-------------------------|---------------|---------------|---------------|
| 1 | Desired Setting | 00 (Ignore This Length) | 07 Characters | 15 Characters | 50 Characters |
| 2 | Scan ENTER/EXIT PROGRAMMING MODE | | | | |
| 3 | Scan SELECT PLESSEY LENGTH 2 SETTING | | | | |
| 4 | Scan Two Characters From the Keypad Appendix | '0' and '0' | '0' and '7' | '1' and '5' | '5' AND '0' |
| 5 | Scan ENTER/EXIT PROGRAMMING MODE | | | | |

Plessey – cont.

Plessey Set Length 2 – cont.

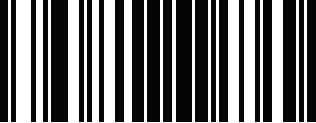
| |
|--|
|  ENTER/EXIT PROGRAMMING MODE |
|--|

| |
|--|
|  Select Plessey Length 2 Setting |
|--|

Make a mistake? Scan the CANCEL barcode to abort and not save the entry string. You can then start again at the beginning.

| |
|---|
|  CANCEL |
|---|



Plessey – cont.

Plessey Minimum Reads

This feature specifies the minimum number of consecutive times a Plessey label must be decoded before it is accepted as good read.

| | |
|--|---|
|  ENTER/EXIT PROGRAMMING MODE | |
| |  Plessey Minimum Reads = 1 |
|  Plessey Minimum Reads = 2 | |
| |  Plessey Minimum Reads = 3 |
|  Plessey Minimum Reads = 4 |  |

Plessey – cont.

Plessey Decoding Level

Decoding Levels are used to configure a barcode symbology decoder to be very aggressive to very conservative depending on a particular customer’s needs.

- Choosing Level 1 results in a very conservative decoder at the expense of not being able to read poorly printed or damaged labels.
- Choosing Level 5 results in a very aggressive decoder. This aggressive behavior allows decoding of poorly printed and damaged labels at the expense of increasing the likelihood of decoding errors.
- Choosing Level 3, which is the default setting, allows the majority of product labels to be decoded.

There are many factors that determine when to change the decoding level for a particular symbology. These factors include spots, voids, non-uniform bar/space widths, damaged labels, etc. that may be experienced in some barcode labels. If there are many hard to read or damaged labels that cannot be decoded using a conservative setting, increase the decoding level to be more aggressive. If the majority of labels are very good quality labels, or there is a need to decrease the possibility of a decoder error, lower the decoding level to a more conservative level.

| | |
|---|--|
|  ENTER/EXIT PROGRAMMING MODE | |
| |  Plessey Decoding Level = Disable |
|  Plessey Decoding Level = 1 | |
| |  Plessey Decoding Level = 2 |

Plessey – cont.

Plessey Decoding Level – cont.

| | |
|---|--|
|  <p>Plessey Decoding Level = 3</p> |  |
| |  <p>Plessey Decoding Level = 4</p> |
|  <p>Plessey Decoding Level = 5</p> | |

Plessey Stitching

Enables/disables fixed length stitching for Plessey.

| | |
|--|---|
|  <p>ENTER/EXIT PROGRAMMING MODE</p> | |
|  |  <p>Plessey Stitching = Disable</p> |
|  <p>Plessey Stitching = Enable</p> | |

Plessey – cont.

Plessey Character Correlation

Enables/disables Character Correlation for Plessey.

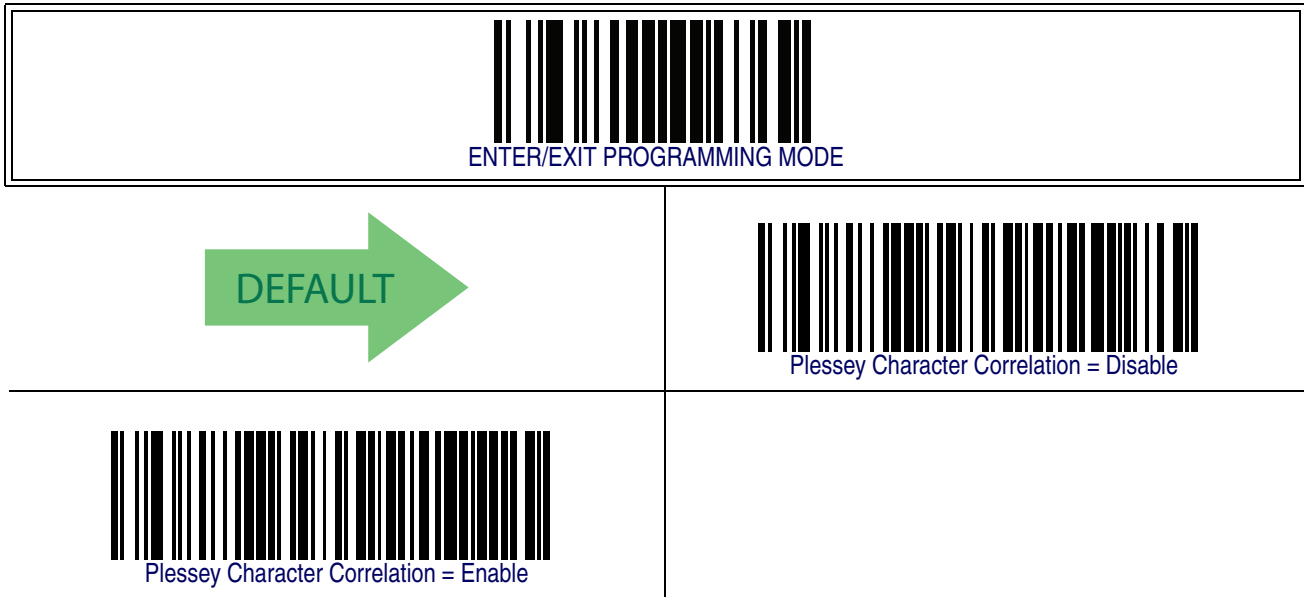

Code 93

The following options apply to the Code 93 symbology.

Code 93 Enable/Disable

Enables/Disables ability of reader to decode Code 93 labels.

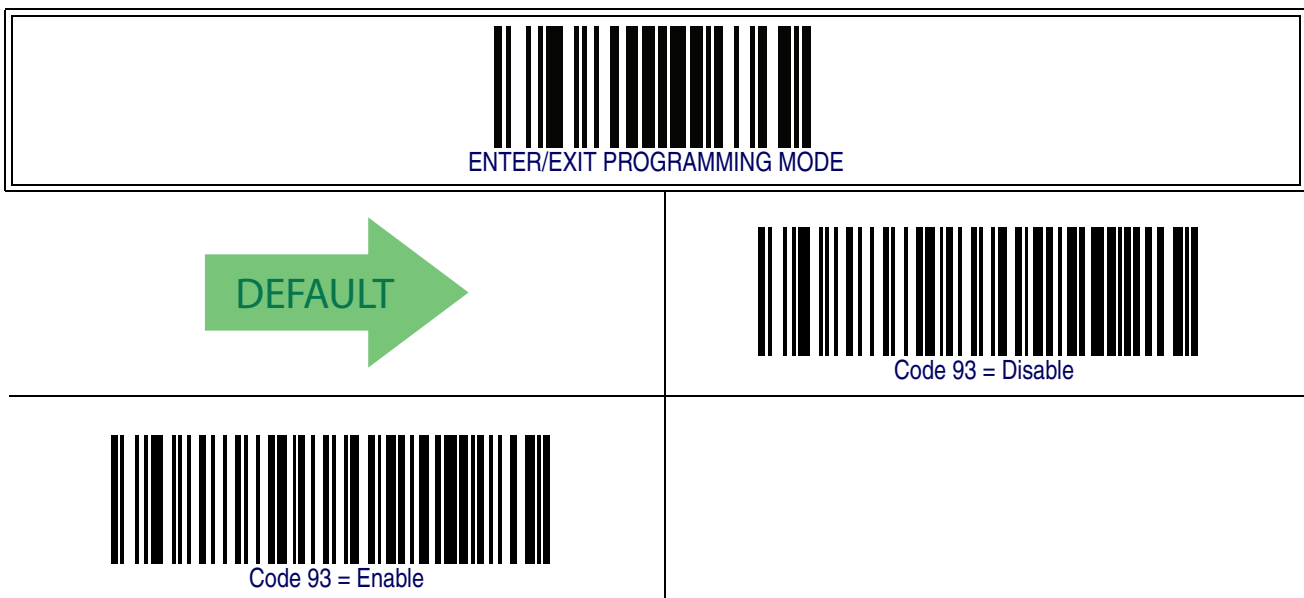

Code 93 — cont.

Code 93 Check Character Calculation

Enables/disables calculation and verification of an optional Code 93 check character.

| | |
|---|--|
|  ENTER/EXIT PROGRAMMING MODE | |
| |  Code 93 Check Character Calculation = Disable |
|  Code 93 Check Character Calculation = Enable Check C | |
| |  Code 93 Check Character Calculation = Enable Check K |
|  Code 93 Check Character Calculation = Enable Check C and K |  |

Code 93 – cont.

Code 93 Check Character Transmission

Enables/disables transmission of an optional Code 93 check character.

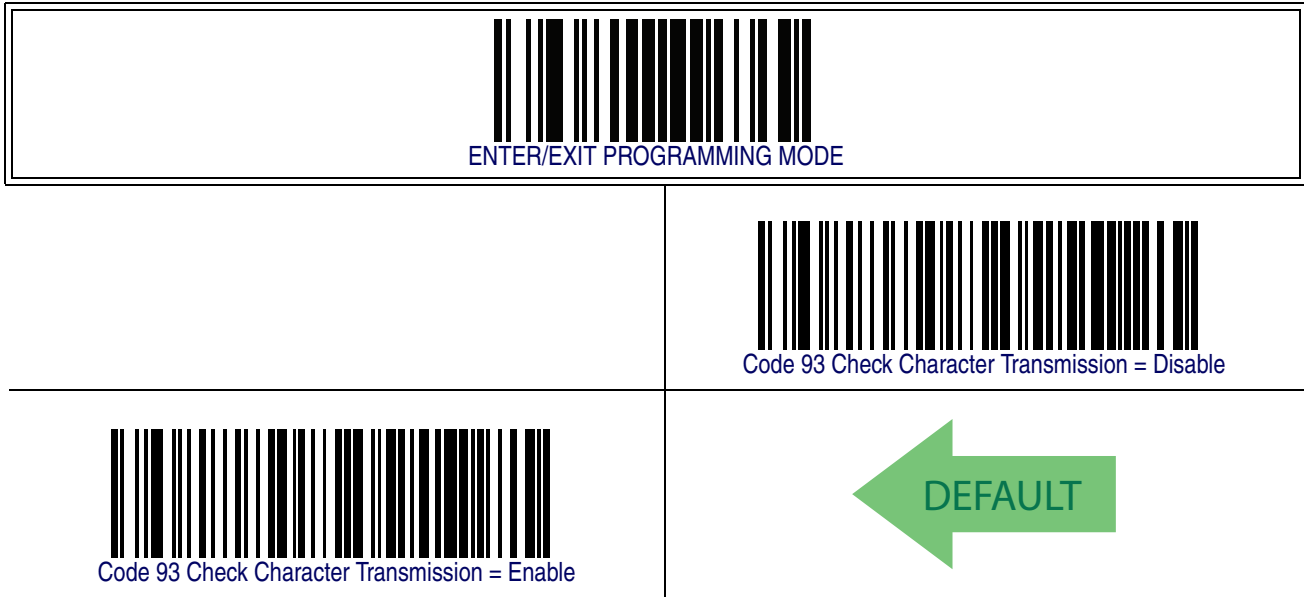

Code 93 Length Control

This feature specifies either variable length decoding or fixed length decoding for the Code 93 symbology.

Variable Length – For variable length decoding, a minimum and maximum length may be set.

Fixed Length – For fixed length decoding, two different lengths may be set.

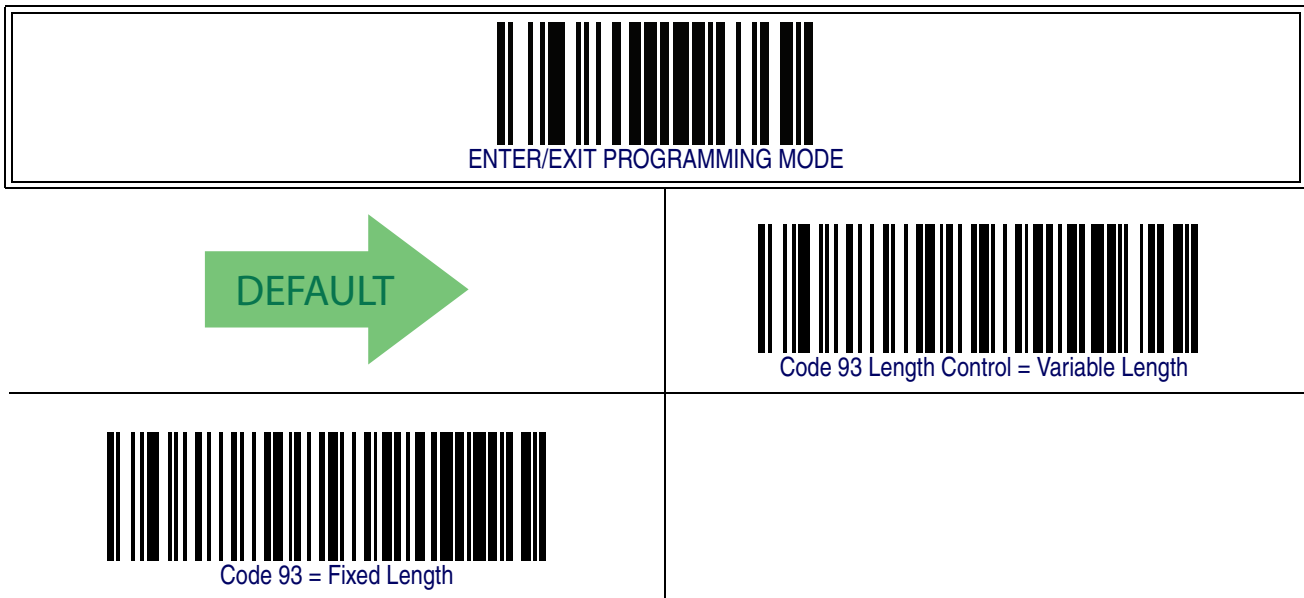

Code 93 – cont.

Code 93 Set Length 1

This feature specifies one of the barcode lengths for **Code 93 Length Control**. Length 1 is the minimum label length if in **Variable Length Mode**, or the first fixed length if in **Fixed Length Mode**. Length includes the barcode's data characters only.

The length can be set from 01 to 50 characters.

Follow these instructions to set this feature:

1. Determine the desired character length (from 0 to 50). Pad the number with leading zeroes to yield two digits. For example: 1 = 01, 5 = 05, 20 = 20, etc.
2. Scan the ENTER/EXIT PROGRAMMING MODE barcode to enter Programming Mode.
3. Scan the barcode: SELECT CODE 93 LENGTH 1 SETTING.
4. Scan the appropriate two digits from the keypad in the Keypad Appendix, that represent the length setting which was determined in the steps above. You will hear a two-beep indication after the last character.



If you make a mistake before the last character, scan the CANCEL barcode to abort and not save the entry string. You can then start again at the beginning.

NOTE

5. Scan the ENTER/EXIT PROGRAMMING MODE barcode to exit Programming Mode.

This completes the procedure. See the table below for some examples of how to set this feature.

Table 41. Code 93 Length 1 Setting Examples

| STEP | ACTION | EXAMPLES | | | |
|------|--|---------------|---------------|---------------|---------------|
| 1 | Desired Setting | 01 Characters | 07 Characters | 15 Characters | 50 Characters |
| 2 | Scan ENTER/EXIT PROGRAMMING MODE | | | | |
| 3 | Scan SELECT CODE 93 LENGTH 1 SETTING | | | | |
| 4 | Scan Two Characters From the Keypad Appendix | '0' and '1' | '0' and '7' | '1' and '5' | '5' AND '0' |
| 5 | Scan ENTER/EXIT PROGRAMMING MODE | | | | |

Code 93 — cont.

Code 93 Set Length 1 — cont.

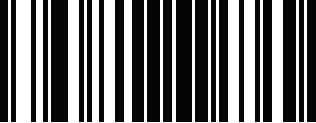
| |
|--|
|  ENTER/EXIT PROGRAMMING MODE |
|--|

| |
|--|
|  Select Code 93 Set Length 1 Setting |
|--|

Make a mistake? Scan the CANCEL barcode to abort and not save the entry string. You can then start again at the beginning.

| |
|---|
|  CANCEL |
|---|

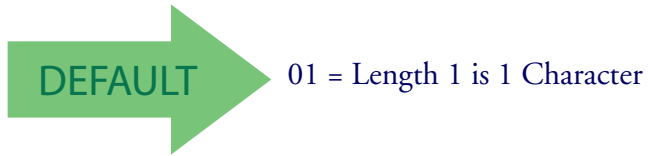

Code 93 — cont.

Code 93 Set Length 2

This feature specifies one of the barcode lengths for [Code 93 Length Control](#). Length 2 is the maximum label length if in [Variable Length Mode](#), or the second fixed length if in [Fixed Length Mode](#). Length includes the barcode's check, data, and full-ASCII shift characters. The length does not include start/stop characters.

The length can be set from 1 to 50 characters. A setting of 0 specifies to ignore this length (only one fixed length).

Follow these instructions to set this feature:

1. Determine the desired character length (from 1 to 50 — or 0 to ignore this length). Pad the number with leading zeroes to yield two digits. For example: 0 = 00, 5 = 05, 20 = 20, etc.
2. Scan the ENTER/EXIT PROGRAMMING MODE barcode to enter Programming Mode.
3. Scan the barcode: SELECT CODE 93 LENGTH 2 SETTING.
4. Scan the appropriate two digits from the keypad in the Keypad Appendix that represent the length setting which was determined in the steps above. You will hear a two-beep indication after the last character.



If you make a mistake, before the last character scan the CANCEL barcode to abort and not save the entry string. You can then start again at the beginning.

NOTE

5. Scan the ENTER/EXIT PROGRAMMING MODE barcode to exit Programming Mode.

This completes the procedure. See the table below for some examples of how to set this feature.

Table 42. CODE 93 Length 2 Setting Examples

| STEP | ACTION | EXAMPLES | | | |
|------|--|-------------------------|---------------|---------------|---------------|
| 1 | Desired Setting | 00 (Ignore This Length) | 07 Characters | 15 Characters | 50 Characters |
| 2 | Scan ENTER/EXIT PROGRAMMING MODE | | | | |
| 3 | Scan SELECT CODE 93 LENGTH 2 SETTING | | | | |
| 4 | Scan Two Characters From the Keypad Appendix | '0' and '0' | '0' and '7' | '1' and '5' | '5' AND '0' |
| 5 | Scan ENTER/EXIT PROGRAMMING MODE | | | | |

Code 93 — cont.

Code 93 Set Length 2 — cont.

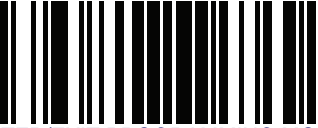
| |
|--|
|  ENTER/EXIT PROGRAMMING MODE |
|--|

| |
|--|
|  Select Code 93 Length 2 Setting |
|--|

Make a mistake? Scan the CANCEL barcode to abort and not save the entry string. You can then start again at the beginning.

| |
|---|
|  CANCEL |
|---|

 50 = Length 2 is 50 Characters

Code 93 — cont.

Code 93 Minimum Reads

This feature specifies the minimum number of consecutive times a Code 93 label must be decoded before it is accepted as good read.



Code 93 – cont.

Code 93 Decoding Level

Decoding Levels are used to configure a barcode symbology decoder to be very aggressive to very conservative depending on a particular customer’s needs.

- Choosing Level 1 results in a very conservative decoder at the expense of not being able to read poorly printed or damaged labels.
- Choosing Level 5 results in a very aggressive decoder. This aggressive behavior allows decoding of poorly printed and damaged labels at the expense of increasing the likelihood of decoding errors.
- Choosing Level 3, which is the default setting, allows the majority of product labels to be decoded.

There are many factors that determine when to change the decoding level for a particular symbology. These factors include spots, voids, non-uniform bar/space widths, damaged labels, etc. that may be experienced in some barcode labels. If there are many hard to read or damaged labels that cannot be decoded using a conservative setting, increase the decoding level to be more aggressive. If the majority of labels are very good quality labels, or there is a need to decrease the possibility of a decoder error, lower the decoding level to a more conservative level.

| | |
|---|--|
|  ENTER/EXIT PROGRAMMING MODE | |
| |  Code 93 Decoding Level = Disable |
|  Code 93 Decoding Level = 1 | |
| |  Code 93 Decoding Level = 2 |

Code 93 – cont.

Code 93 Decoding Level – cont.

| | |
|---|--|
|  <p>Code 93 Decoding Level = 3</p> |  |
| |  <p>Code 93 Decoding Level = 4</p> |
|  <p>Code 93 Decoding Level = 5</p> | |

Code 93 – cont.

Code 93 Quiet Zones

Enables/disables fixed length stitching for Code 93.

| | |
|---|--|
|  ENTER/EXIT PROGRAMMING MODE | |
| |  Code 93 Quiet Zones = No Quiet Zones |
|  Code 93 Quiet Zones = Quiet Zone on one side | |
| |  Code 93 Quiet Zones = Quiet Zones on two sides |
|  Code 93 Quiet Zones = Auto |  DEFAULT |
| |  Code 93 Quiet Zones = Virtual Quiet Zones on two sides |

Code 93 – cont.

Code 93 Stitching

Disable/enable fixed or variable length stitching for Code 93.



Code 93 Character Correlation

Enables/disables Character Correlation for Code 93.



Codablock F

The following options apply to the Codablock F symbology.

Codablock F Enable/Disable

Enables/Disables the ability of the imager to decode Codablock F labels.

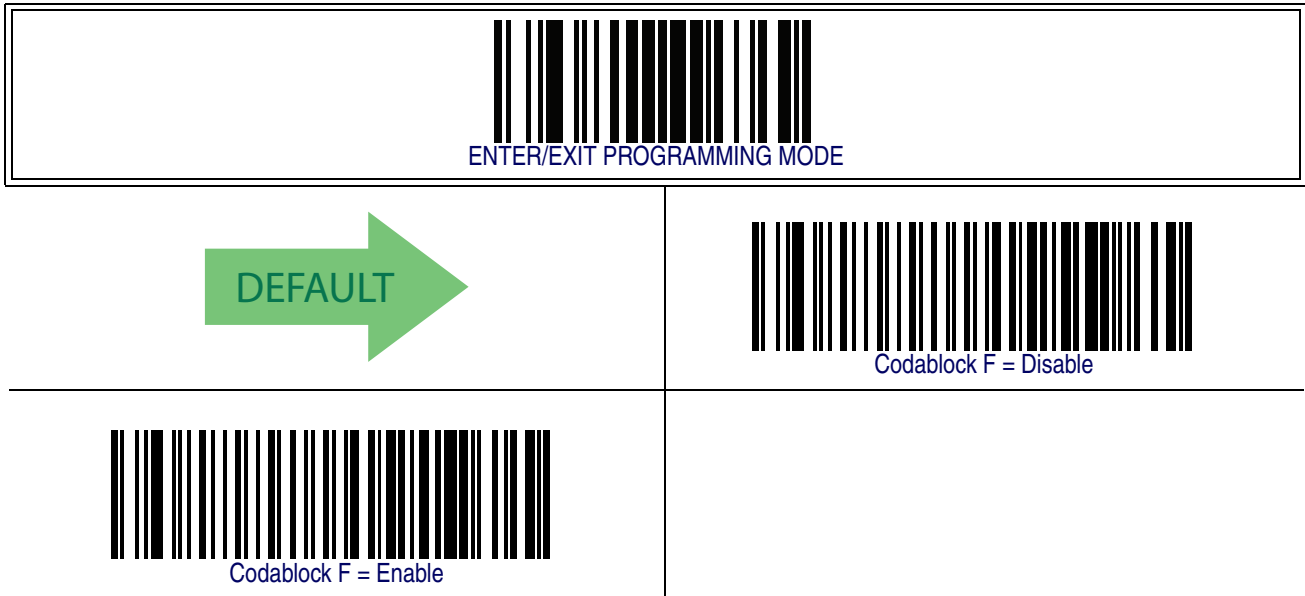

Codablock F – cont.

Codablock F EAN Enable/Disable

Enables/Disables the Codablock F EAN subtype (code with FNC1 in the first position).



Codablock F AIM Check

Specifies if Check Digit calculation algorithm is AIM compliant or not.



Codablock F – cont.

Codablock F Length Control

This feature specifies either variable length decoding or fixed length decoding for the Codablock F symbology.

Variable Length – For variable length decoding, a minimum and maximum length may be set.

Fixed Length – For fixed length decoding, two different lengths may be set.

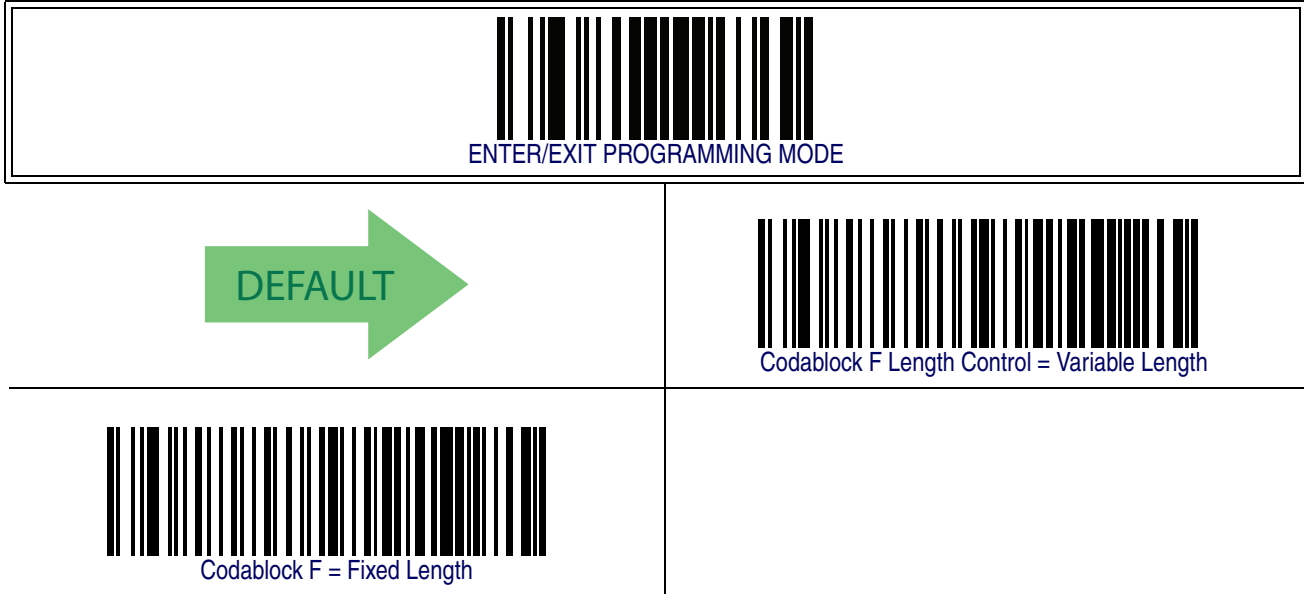

Codablock F – cont.

Codablock F Set Length 1

This feature specifies one of the barcode lengths for [Codablock F Length Control](#). Length 1 is the minimum label length if in [Variable Length Mode](#), or the first fixed length if in [Fixed Length Mode](#). Length includes the barcode's data characters only. The length can be set from 003 to 255 characters.

Follow these instructions to set this feature:

1. Determine the desired character length (from 3 to 255). Pad the number with leading zeroes to yield three digits. For example: 3 = 003, 5 = 005, 20 = 020, etc.
2. Scan the ENTER/EXIT PROGRAMMING MODE barcode to enter Programming Mode.
3. Scan the barcode: SELECT CODABLOCK F LENGTH 1 SETTING.
4. Scan the appropriate three digits from the keypad in the Keypad Appendix, that represent the length setting which was determined in the steps above. You will hear a two-beep indication after the last character.



If you make a mistake before the last character, scan the CANCEL barcode to abort and not save the entry string. You can then start again at the beginning.

NOTE

5. Scan the ENTER/EXIT PROGRAMMING MODE barcode to exit Programming Mode.

This completes the procedure. See the table below for some examples of how to set this feature.

Table 43. CODABLOCK F Length 1 Setting Examples

| STEP | ACTION | EXAMPLES | | | |
|------|--|------------------|------------------|------------------|------------------|
| 1 | Desired Setting | 003 Characters | 007 Characters | 015 Characters | 050 Characters |
| 2 | Scan ENTER/EXIT PROGRAMMING MODE | | | | |
| 3 | Scan SELECT CODABLOCK F LENGTH 1 SETTING | | | | |
| 4 | Scan three Characters From the Keypad Appendix | '0', '0' and '3' | '0', '0' and '7' | '0', '1' and '5' | '0', '5' AND '0' |
| 5 | Scan ENTER/EXIT PROGRAMMING MODE | | | | |

Codablock F — cont.

Codablock F Set Length 1 — cont.

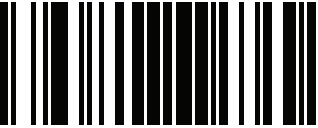
| |
|--|
|  ENTER/EXIT PROGRAMMING MODE |
|--|

| |
|--|
|  Select Codablock F Length 1 Setting |
|--|

Make a mistake? Scan the CANCEL barcode to abort and not save the entry string. You can then start again at the beginning.

| |
|---|
|  CANCEL |
|---|

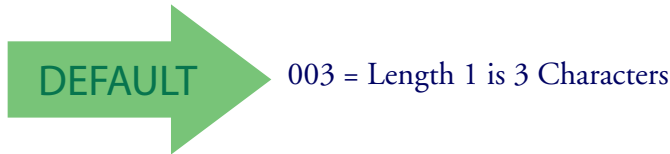

Codablock F – cont.

Codablock F Set Length 2

This feature specifies one of the barcode lengths for [Codablock F Length Control](#). Length 2 is the maximum label length if in [Variable Length Mode](#), or the second fixed length if in [Fixed Length Mode](#). Length includes the barcode's check, data, and full-ASCII shift characters. The length does not include start/stop characters.

The length can be set from 3 to 255 characters. A setting of 0 specifies to ignore this length (only one fixed length).

Follow these instructions to set this feature:

1. Determine the desired character length (from 3 to 255 — or 0 to ignore this length). Pad the number with leading zeroes to yield three digits. For example: 0 = 000, 5 = 005, 20 = 020, etc.
2. Scan the ENTER/EXIT PROGRAMMING MODE barcode to enter Programming Mode.
3. Scan the barcode: SELECT CODABLOCK F LENGTH 2 SETTING.
4. Scan the appropriate three digits from the keypad in the Keypad Appendix that represent the length setting which was determined in the steps above. You will hear a two-beep indication after the last character.



If you make a mistake, before the last character scan the CANCEL barcode to abort and not save the entry string. You can then start again at the beginning.

NOTE

5. Scan the ENTER/EXIT PROGRAMMING MODE barcode to exit Programming Mode.

This completes the procedure. See the table below for some examples of how to set this feature.

Table 44. CODABLOCK Length 2 Setting Examples

| STEP | ACTION | EXAMPLES | | | |
|------|--|--------------------------|------------------|------------------|------------------|
| 1 | Desired Setting | 000 (Ignore This Length) | 007 Characters | 015 Characters | 050 Characters |
| 2 | Scan ENTER/EXIT PROGRAMMING MODE | | | | |
| 3 | Scan SELECT CODABLOCK F LENGTH 2 SETTING | | | | |
| 4 | Scan three Characters From the Keypad Appendix | '0', '0' and '0' | '0', '0' and '7' | '0', '1' and '5' | '0', '5' AND '0' |
| 5 | Scan ENTER/EXIT PROGRAMMING MODE | | | | |

Codablock F — cont.

Codablock F Set Length 2 — cont.

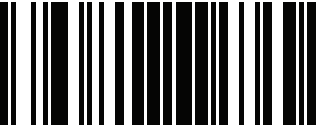
| |
|--|
|  ENTER/EXIT PROGRAMMING MODE |
|--|

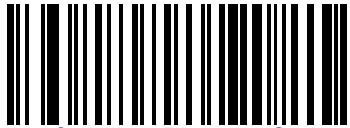
| |
|--|
|  Select Codablock F Length 2 Setting |
|--|

| |
|--|
| |
|--|

Make a mistake? Scan the CANCEL barcode to abort and not save the entry string. You can then start again at the beginning.

| |
|---|
|  CANCEL |
|---|

 100 = Length 2 is 100 Characters

Code 4

The following options apply to the Code 4 symbology.

Code 4 Enable/Disable

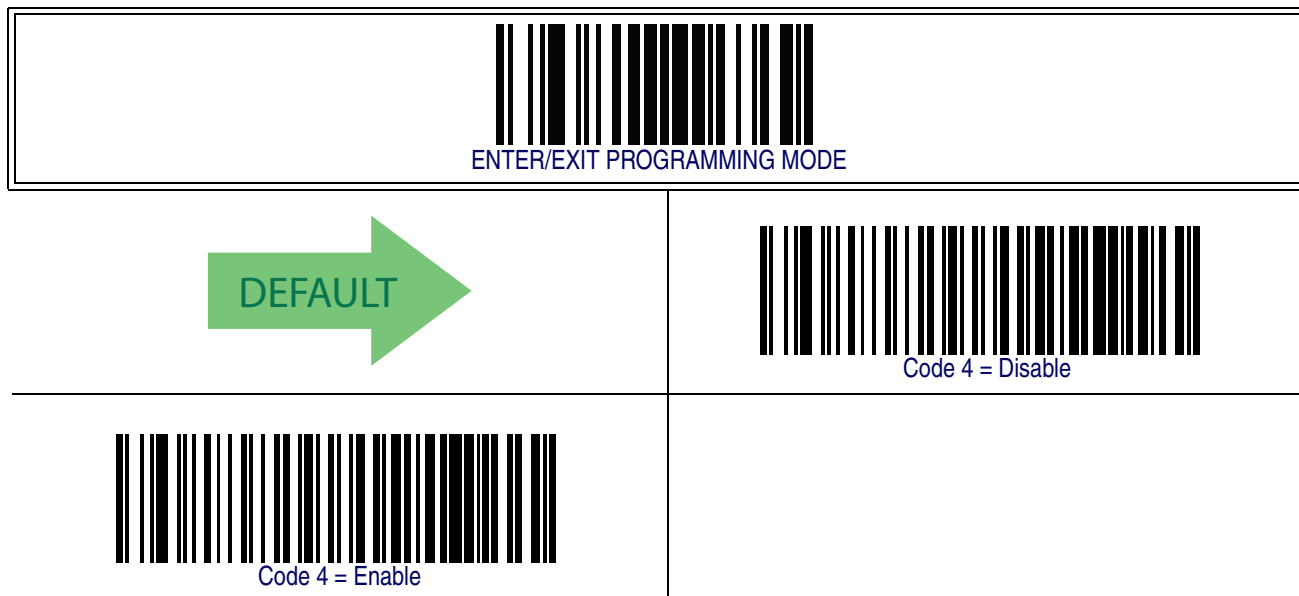

Enables/Disables ability of imager to decode Code 4 labels.



Code 4 – cont.

Code 4 Check Character Transmission

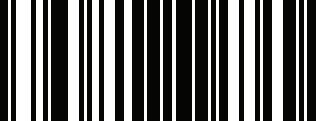
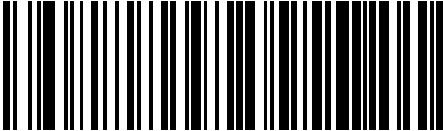
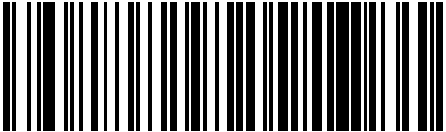
This feature enables/disables transmission of an optional Code 4 check character.

| | |
|---|--|
|  ENTER/EXIT PROGRAMMING MODE | |
| |  Code 4 Check Character Transmission = Don't Send |
|  Code 4 Check Character Transmission = Send |  |

Code 4 Hex to Decimal Conversion

This feature enables/disables the conversion of hexadecimal label data to decimal label data.

| | |
|--|--|
|  ENTER/EXIT PROGRAMMING MODE | |
| |  Code 4 Hex to Decimal Conversion = Disable |
|  Code 4 Hex to Decimal Conversion = Enable |  |

Code 5

The following options apply to the Code 5 symbology.

Code 5 Enable/Disable

Enables/Disables ability of imager to decode Code 5 labels.

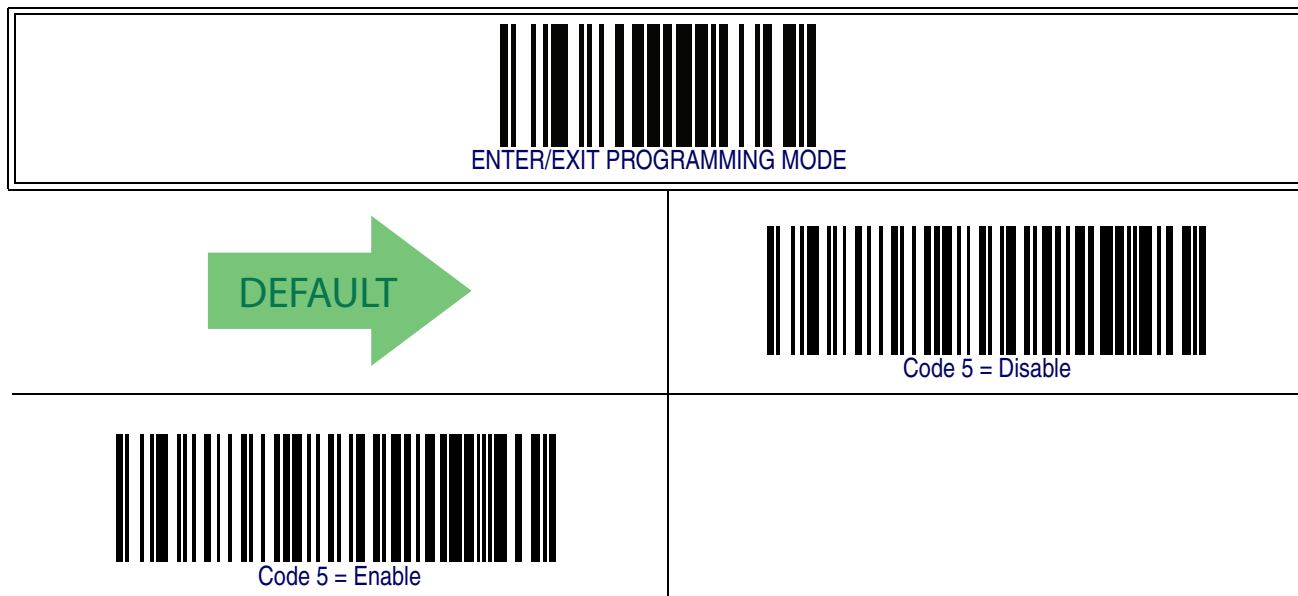

Code 5 – cont.

Code 5 Check Character Transmission

This feature enables/disables transmission of an optional Code 5 check character.

| | |
|---|--|
|  ENTER/EXIT PROGRAMMING MODE | |
| |  Code 5 Check Character Transmission = Don't Send |
|  Code 5 Check Character Transmission = Send |  |

Code 5 Hex to Decimal Conversion

This feature enables/disables the conversion of hexadecimal label data to decimal label data.

| | |
|--|--|
|  ENTER/EXIT PROGRAMMING MODE | |
| |  Code 5 Hex to Decimal Conversion = Disable |
|  Code 5 Hex to Decimal Conversion = Enable |  |

Code 4 and Code 5 Common Configuration Items

The following options apply to both Code 4 and Code 5 symbologies.

Code 4 and 5 Decoding Level

Decoding Levels are used to configure a barcode symbology decoder to be very aggressive to very conservative depending on a particular customer's needs.

- Choosing Level 1 results in a very conservative decoder at the expense of not being able to read poorly printed or damaged labels.
- Choosing Level 5 results in a very aggressive decoder. This aggressive behavior allows decoding of poorly printed and damaged labels at the expense of increasing the likelihood of decoding errors.
- Choosing Level 3, which is the default setting, allows the majority of product labels to be decoded.

There are many factors that determine when to change the decoding level for a particular symbology. These factors include spots, voids, non-uniform bar/space widths, damaged labels, etc. that may be experienced in some barcode labels. If there are many hard to read or damaged labels that cannot be decoded using a conservative setting, increase the decoding level to be more aggressive. If the majority of labels are very good quality labels, or there is a need to decrease the possibility of a decoder error, lower the decoding level to a more conservative level.





This configuration item applies to Code 4 and Code 5.

NOTE

Code 4 and Code 5 Common Configuration Items – cont.

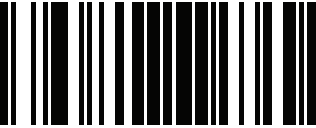
Code 4 and 5 Decoding Level – cont.

| | |
|---|--|
|  ENTER/EXIT PROGRAMMING MODE | |
|  Code 4 and Code 5 Decoding Level = 1 | |
| |  Code 4 and Code 5 Decoding Level = 2 |
|  Code 4 and Code 5 Decoding Level = 3 |  DEFAULT |
| |  Code 4 and Code 5 Decoding Level = 4 |
|  Code 4 and Code 5 Decoding Level = 5 | |

Code 4 and Code 5 Common Configuration Items – cont.

Code 4 and Code 5 Minimum Reads

This feature specifies the minimum number of consecutive times a Code 4 or Code 5 label must be decoded before it is accepted as good read.

| | |
|---|--|
|  ENTER/EXIT PROGRAMMING MODE | |
|  DEFAULT |  Code 4 or Code 5 Minimum Reads = 1 |
|  Code 4 or Code 5 Minimum Reads = 2 | |
| |  Code 4 or Code 5 Minimum Reads = 3 |
|  Code 4 or Code 5 Minimum Reads = 4 | |

Follett 2 of 5

The following options apply to the Follett 2 of 5 symbology.

Follett 2 of 5 Enable/Disable

Enables/Disables ability of imager to decode Follett 2 of 5 labels.

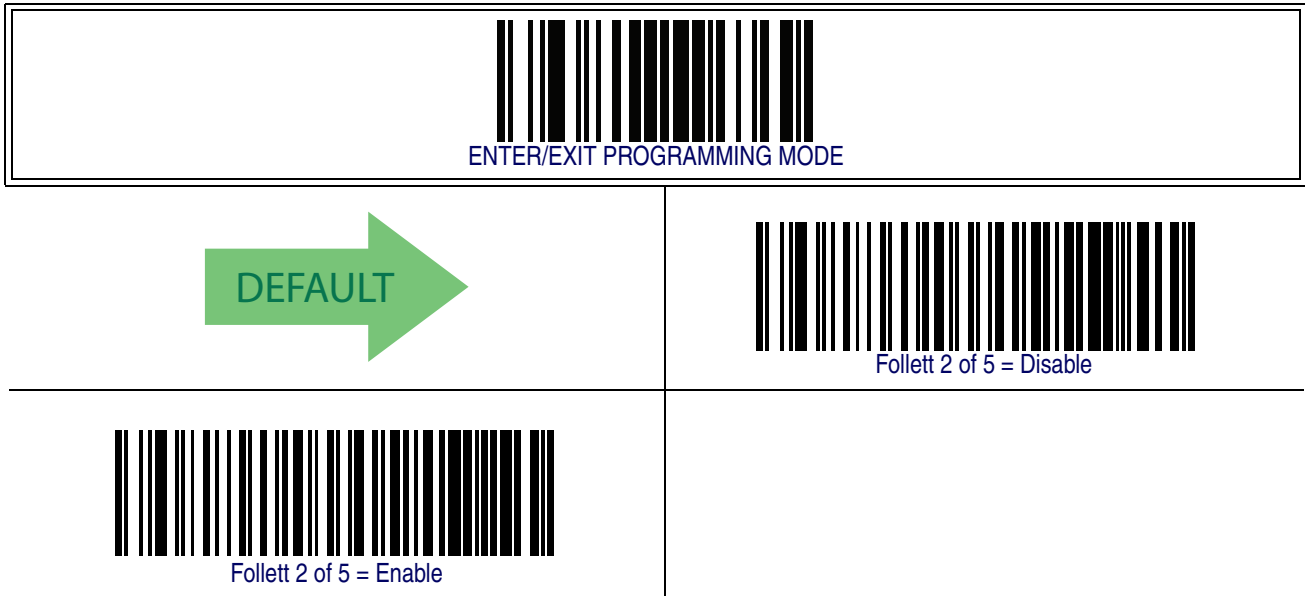

Chapter 13

BT Features

Introduction

This section provides options and programming related to the reader's radio communication features.

Standard Factory Settings

Reference [Appendix B, Standard Defaults](#) for a listing of standard factory settings.

BT Beeper Features

Several options are available to configure beeper behavior for BT operation.

ACK Beep

Enables/disables the ACK beep indication. The ACK beep occurs in reponse to the label acknowledgement (HACK) from the Base Station. The HACK signal is sent according to the settings made for [BT Address Stamping on page 364](#).









Beep Frequency

Adjusts radio-specific beep indications to sound at a low, medium or high frequency, selectable from the list below. (Controls the beeper's pitch/tone.)

| | |
|--|--|
|  ENTER/EXIT PROGRAMMING MODE | |
|  |  Beep Frequency = Low |
|  Beep Frequency = Medium | |
| |  Beep Frequency = High |

Beep Duration

This feature controls the duration of radio-specific beep indications.

| | |
|--|--|
|  ENTER/EXIT PROGRAMMING MODE | |
| |  Beep Duration = 60 msec |
|  Beep Duration = 80 msec |  |
| |  Beep Duration = 100 msec |
|  Beep Duration = 120 msec | |
| |  Beep Duration = 140 msec |

Beep Duration — cont.

| | |
|--|--|
|  ENTER/EXIT PROGRAMMING MODE | |
|  Beep Duration = 160 msec | |
| |  Beep Duration = 180 msec |
|  Beep Duration = 200 msec | |

Beep Volume

Selects the beeper volume (loudness) of radio-specific beep indications. There are three selectable volume levels.

| | |
|--|--|
|  ENTER/EXIT PROGRAMMING MODE | |
|  Beep Volume = Low | |
| |  Beep Volume = Medium |
|  Beep Volume = High |  |

BT Base Station Beep

Enables/disables a beep indication when the handheld is placed in the Base Station.



Disconnect Beep

Enables/disables the beep indication that a handheld has become disconnected from a Base Station.



BT Leash Alarm

This setting specifies the number of seconds to sound the Leash Mode beeps (three per second) when the handheld goes out of range. This is especially useful in instances where the reader might inadvertently have been placed in a bag or cart.

For this mode to be effective, the feature [Sleep Mode Timeout on page 23](#), must be disabled. If the reader is asleep, there is no way for it to know where it is relative to the Base Station because communication is not active between the devices.

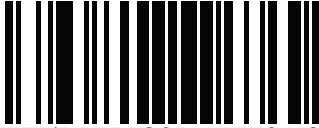
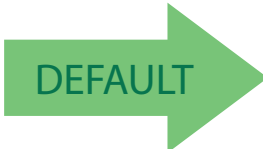
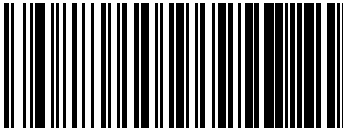
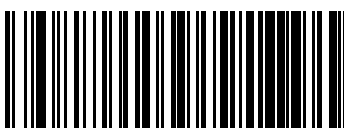
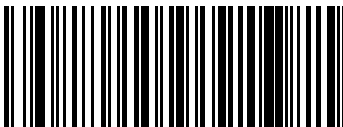
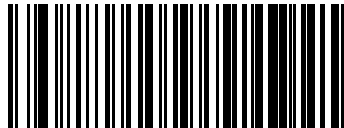
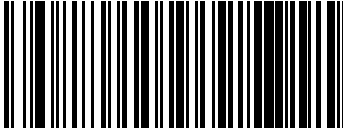
| | |
|---|--|
|  ENTER/EXIT PROGRAMMING MODE | |
|  |  BT Leash Alarm = Disabled |
|  BT Leash Alarm = 1 Second | |
| |  BT Leash Alarm = 2 Seconds |
|  BT Leash Alarm = 3 Seconds | |
| |  BT Leash Alarm = 4 Seconds |

BT Leash Alarm – cont.

| | |
|--|---|
|  ENTER/EXIT PROGRAMMING MODE | |
|  BT Leash Alarm = 5 Seconds | |
| |  BT Leash Alarm = 10 Seconds |
|  BT Leash Alarm = 25 Seconds | |
| |  BT Leash Alarm = 30 Seconds |

Flash Update

BT Automatic Flash Update

This feature enables/disables the automatic flash update of a reader.



Request Flash Update

Scan this barcode to request a flash update from a Base Station



Do not scan an ENTER/EXIT PROGRAMMING MODE label in conjunction with this barcode.

NOTE

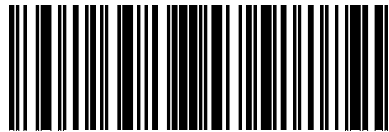

Request Flash Update

Configuration Update

Automatic Configuration Update

When this feature is enabled, a reader and its linked Base Station can automatically ensure they stay in sync with regard to application hardware and/or configuration. This is accomplished by the linked reader and Base Station comparing application version number and configuration file check sum. If either is different, the Base Station will automatically update the reader with its application/configuration.

If the units are linked, any changes made to the Base Station configuration through the Aladdin™ software will automatically be sent to the reader at the completion of the programming session.

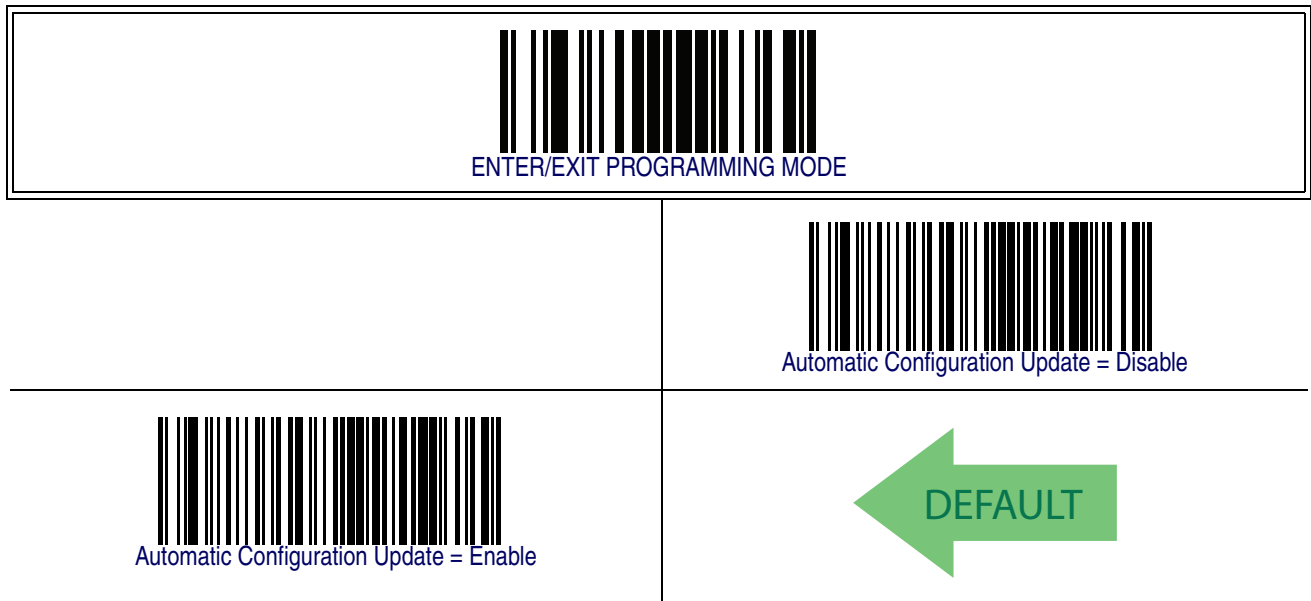

Configuration Update From Base Station to Handheld

Scan this barcode to manually request a one-time configuration update from the Base Station to the handheld.



Do not scan an ENTER/EXIT PROGRAMMING MODE label in conjunction with this barcode.

NOTE



Configuration Update From Base Station to Handheld

Configuration Update — cont.

Copy Configuration From Handheld to Base Station

Use this barcode to manually copy the handheld configuration to the Base Station.



Do not scan an ENTER/EXIT PROGRAMMING MODE label in conjunction with this barcode.

NOTE

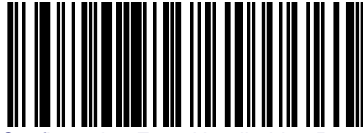

Copy Configuration From Handheld to Base Station

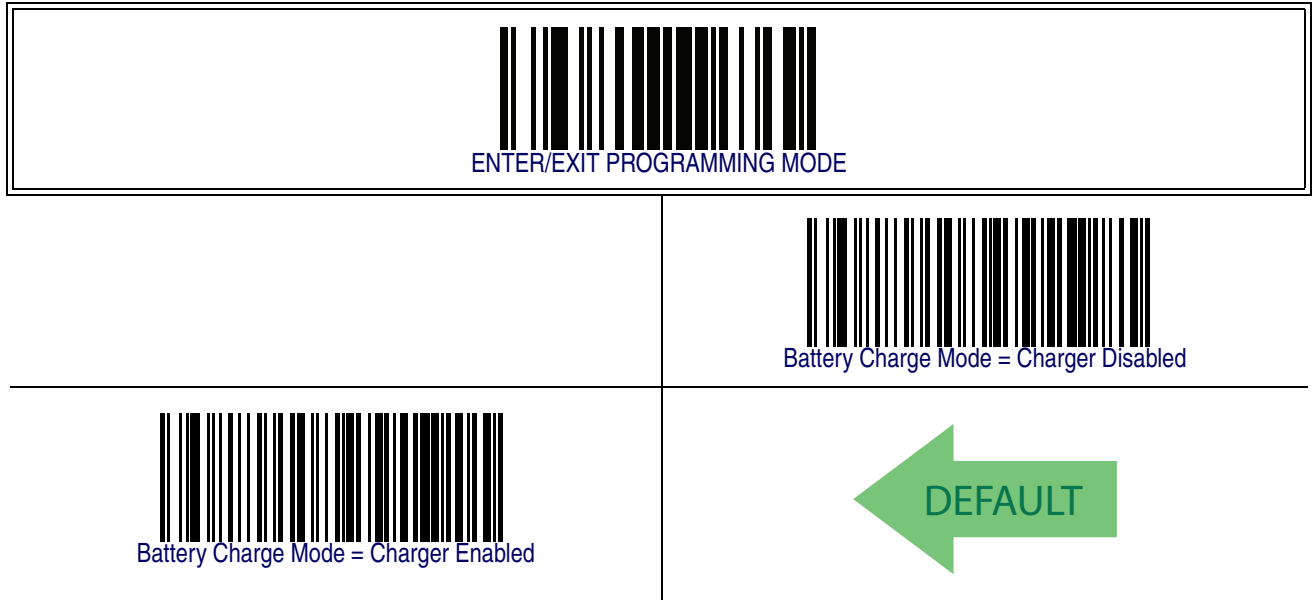

Battery Charge Mode

This feature specifies the battery charge mode for the Base Station.

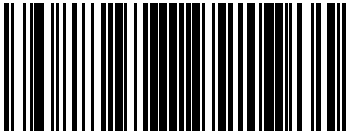

Powerdown Timeout

The Powerdown Timeout feature sets the time for automatically switching the unit off when the imager has been idle.

| | |
|---|--|
|  ENTER/EXIT PROGRAMMING MODE | |
| |  Powerdown Timeout = Disable |
|  Powerdown Timeout = 10 minutes | |
| |  Powerdown Timeout = 20 minutes |
|  Powerdown Timeout = 30 minutes | |
| |  Powerdown Timeout = 40 minutes |

Powerdown Timeout – continued



BT Poll Rate

This feature Specifies the time between BT polls.

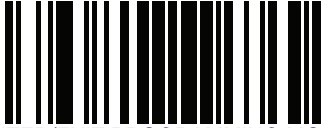
| | |
|--|---|
|  ENTER/EXIT PROGRAMMING MODE | |
|  BT Poll Rate = Maximum BT Poll Rate | |
| |  BT Poll Rate = 10 ms |
|  BT Poll Rate = 20 ms |  |
| |  BT Poll Rate = 30 ms |
|  BT Poll Rate = 50 ms | |
| |  BT Poll Rate = 100 ms |

BT Poll Rate – cont.

| | |
|--|---|
|  ENTER/EXIT PROGRAMMING MODE | |
|  BT Poll Rate = 150 ms | |
| |  BT Poll Rate = 200 ms |
|  BT Poll Rate = 500 ms | |
| |  BT Poll Rate = 990 ms |

Batch Features

Batch Mode

This option specifies which mode to use to store labels in the handheld while disconnected from the base. Options are as follows:

- Disabled — The handheld will not store/batch labels.
- Automatic — The handheld will store labels to RAM when the handheld goes out of range and is disconnected from the remote device.
- Manual — The handheld will always store labels to Flash memory. The user must manually send the stored labels to the remote device using a special "batch send" label.

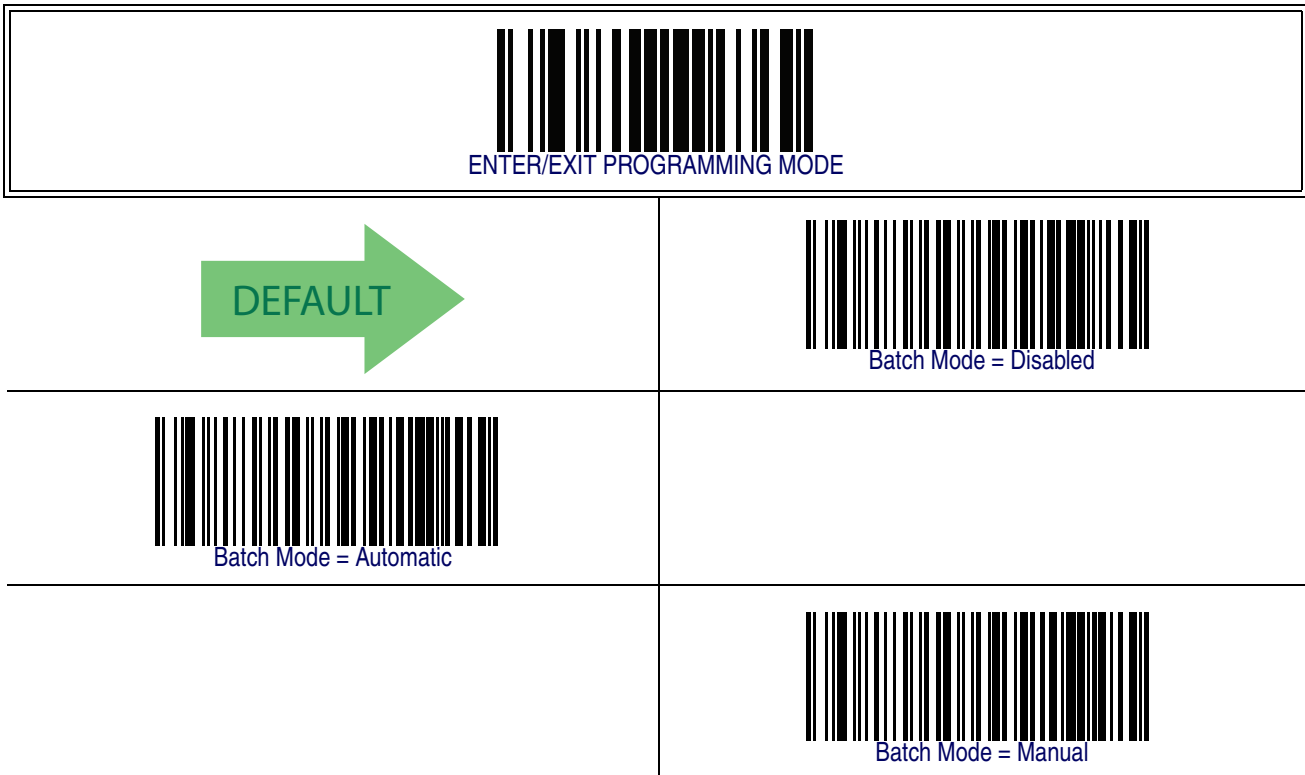

Batch Features – cont.

Send Batch

Use this barcode to initiate sending of labels stored in batch memory.



Do not scan an ENTER/EXIT PROGRAMMING MODE label in conjunction with this barcode.

NOTE

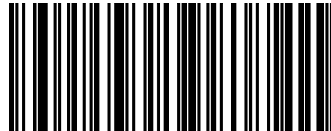

Send Batch

Erase Batch Memory

Use this barcode to erase any labels stored in batch memory.



Do not scan an ENTER/EXIT PROGRAMMING MODE label in conjunction with this barcode.

NOTE

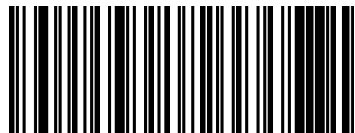

Erase Batch Memory

Batch Features – cont.

BT Batch Mode Transmit Delay

Enables/disables the ability of the Base Station to emulate a PowerScan 7000 model Base Station. When enabled, the Base Station can link with a PowerScan 7000BT handheld.

| | |
|---|--|
|  ENTER/EXIT PROGRAMMING MODE | |
|  |  BT Batch Mode Transmit Delay = No Delay |
|  BT Batch Mode Transmit Delay = 0.5 Second | |
| |  BT Batch Mode Transmit Delay = 1 Second |
|  BT Batch Mode Transmit Delay = 2.5 Seconds | |

BT Security Features

These features enable/disable the BT system to require a configurable pin code to authenticate/connect the BT devices, and encrypt the data.

BT Pin Code

This option specifies the 4-character pin code to be used for authentication of the BT link. [BT Security Mode on page 362](#) must be enabled in order to require the pin code.

To set the pin code:

1. Determine the desired characters. For example, D254.
2. Convert the characters to hexadecimal using the [ASCII Chart](#) on the inside back cover of this manual. In the case of the example, the hexadecimal equivalents would be:

D = 0x44, 2 = 0x32, 5 = 0x35, and 4 = 0x34

3. Scan the ENTER/EXIT PROGRAMMING MODE barcode to enter Programming Mode.
4. Scan the barcode: SELECT BT PIN CODE.
5. Scan the appropriate alpha-numeric characters from the keypad in [Appendix E, Keypad](#) representing the hexadecimal entries which was determined in the steps above. You will hear a two-beep indication after the last character.



If you make a mistake before the last character, scan the CANCEL barcode to abort and not save the entry string. You can then start again at the beginning.

NOTE

6. Scan the ENTER/EXIT PROGRAMMING MODE barcode to exit Programming Mode.

This completes the procedure. See [Table 45](#) for some examples of how to set this feature.



Changing the pin code setting will unlink the devices. If the Automatic Configuration Update is set to the default enabled setting, the devices must only be relinked. If the Automatic Configuration Update is set to the disabled setting, the Pin Code setting must also be updated in the Base Station using Aladdin. After the Base Station has been updated the devices must be relinked.

NOTE

This completes the procedure. See [Table 45](#) for some examples of how to set this feature.

Table 45. BT Pin Code Setting Examples

| STEP | ACTION | EXAMPLES | | | |
|------|---|-------------|-------------|-------------|-------------|
| 1 | Desired Setting | 1234 | D254 | 1359 | STOR |
| 2 | Convert the characters to hexadecimal | 31 32 33 34 | 44 32 35 34 | 31 33 35 39 | 53 54 4F 52 |
| 3 | Scan ENTER/EXIT PROGRAMMING MODE | | | | |
| 4 | Scan SELECT LABEL GONE TIMEOUT SETTING | | | | |
| 5 | Scan the Eight Alpha-Numeric Characters From Appendix E, Keypad | 31323334 | 44323534 | 31333539 | 53544F52 |
| 6 | Scan ENTER/EXIT PROGRAMMING MODE | | | | |

BT Pin Code — cont.

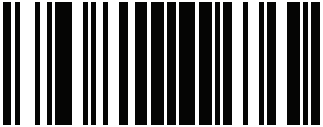
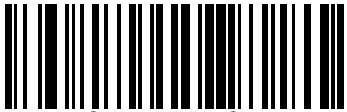
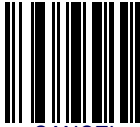
| | |
|--|---|
|  ENTER/EXIT PROGRAMMING MODE | |
|  Select BT Pin Code | |
| Make a mistake? Scan the CANCEL barcode to abort and not save the entry string. You can then start again at the beginning. |  CANCEL |

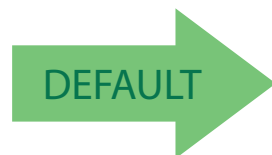

31323334 = Default Pin Code is 1234

BT Security Mode

This feature enables/disables authentication and encryption of the BT link. Use the feature, [BT Pin Code on page 359](#), to specify the pin code used to authenticate the BT Link.



NOTE

Changing the security mode setting will unlink the devices. If the Automatic Configuration Update is set to the default enabled setting, the devices must only be relinked. If the Automatic Configuration Update is set to the disabled setting, the Security Mode setting must also be updated in the Base Station using Aladdin. After the Base Station has been updated the devices must be relinked.

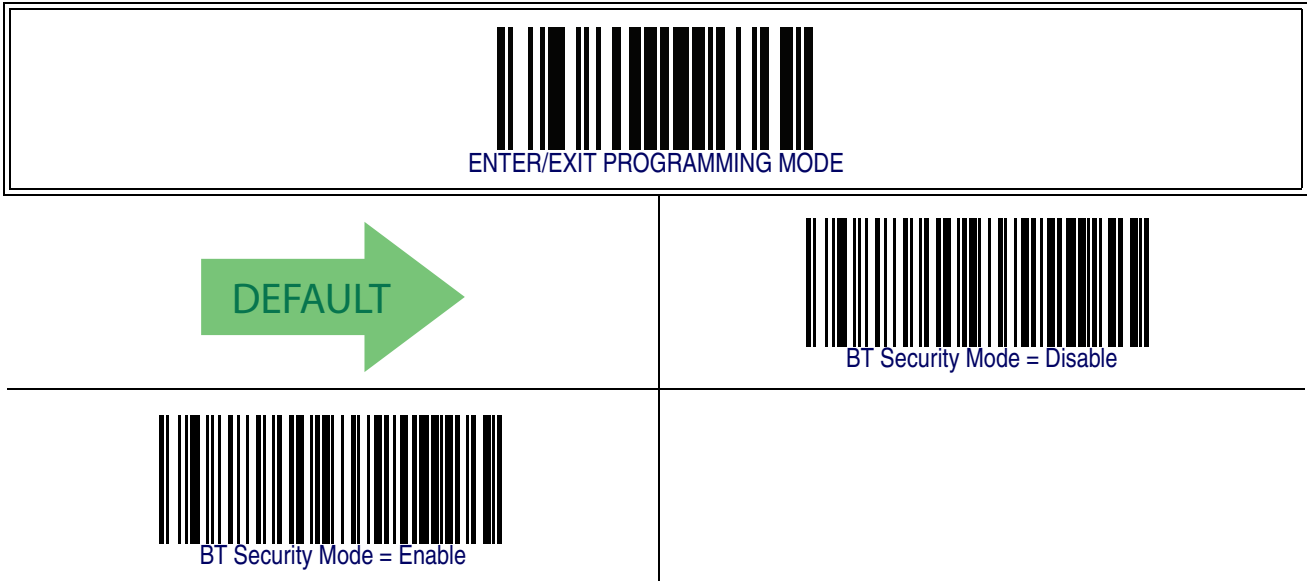

Linking the Reader

The PBT7100 reader can link to a PBT7100 Base Station or to a PC. See the [Getting Started](#) section in the front of this manual for information. See the following section for information on linking a PowerScan 7000 reader to a PBT7100 Base Station.

Optional: Linking a PowerScan 7000 Reader to a PBT7100 Base Station

A PowerScan 7000 reader can optionally be linked in Serial Port Profile mode to a PBT7100 Base Station. In this configuration, the paging feature and host commands are not supported.



To use this feature, [BT Security Mode on page 362](#) must be disabled.

NOTE

To do this, follow these steps:

1. Enable the SPP Mode in the Base Station by scanning the “[BT SPP Mode = Enable](#)” label with a PBT7100 reader that is linked to the PBT7100 Base Station. Optionally, Aladdin may be used to enable SPP Mode in the Base Station.
2. Create a Code 128 link barcode with the following format: <Fnc3>LnkB<12 character Base Station bluetooth address>. The bluetooth address of the Base Station can be found printed below the barcode on the top of the PowerScan 7100 Base Station.
3. Put the PowerScan 7100 Base Station in link mode by pressing the button for 2 seconds and then scan the link label created in step 2 with the PowerScan 7000 reader.



A PBT7100 reader can link in SPP mode to a PBT7100 Base Station using the label created in step 2.

NOTE

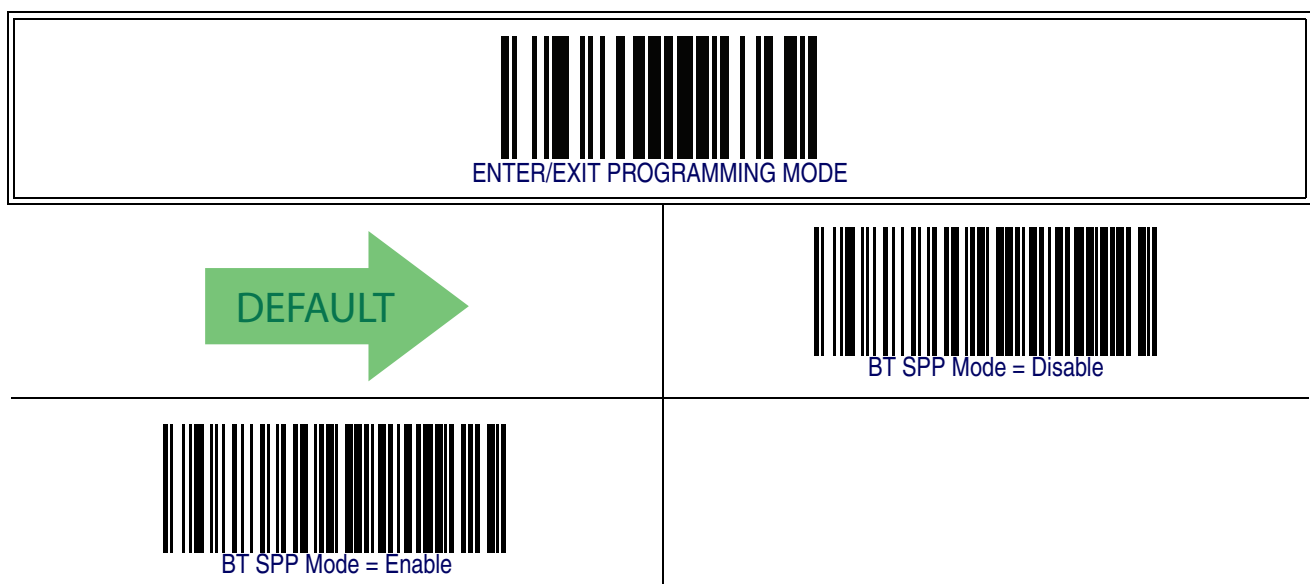

BT Address Stamping

These features allow configuration of source radio data inclusion.

Source Radio Address Transmission

Enables/disables the ability of source radio information to be transmitted to the host and, if so, at what position with respect to the label data.

Options are:

Do Not Include — Do not include source-radio ID

Prefix — Include source-radio ID as prefix



NOTE

When included as a prefix, the source-radio ID is displayed after all label formatting has been applied.

The 6 byte hex address is sent as 12 ascii characters, ie, an address of:

00 06 66 00 1A ED

will be sent as (shown in hex):

30 30 30 36 36 36 30 30 31 41 45 44

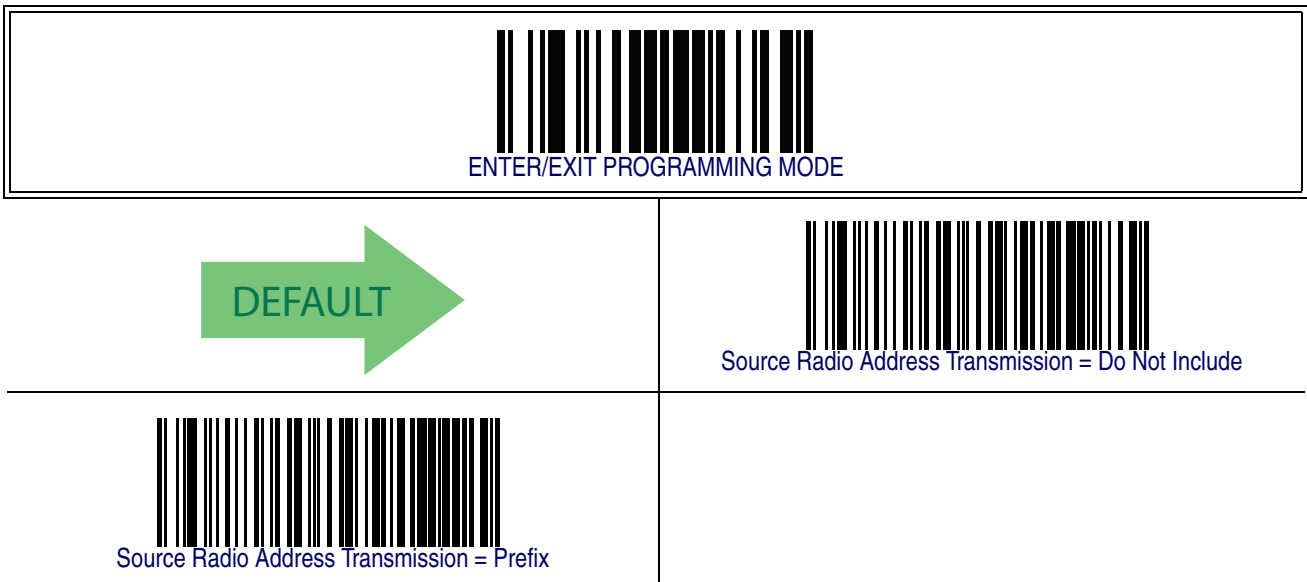

Source Radio Address Delimiter Character

This option specifies the delimiter character to be placed between the label data and radio address when address stamping is enabled.



This feature only applies if [Source Radio Address Transmission](#) on [page 364](#) is enabled.

NOTE

Follow these instructions to select the delimiter character:

1. Determine the desired character, then find its hexadecimal equivalent on the [ASCII Chart](#) on the inside back cover. A setting of 00 specifies no delimiter character.
2. Scan the ENTER/EXIT PROGRAMMING MODE barcode to enter Programming Mode.
3. Scan the barcode: SET SOURCE RADIO ADDRESS DELIMITER CHARACTER.
4. Scan the appropriate two digits from the keypad in [Appendix E, Keypad](#), that represent the hexadecimal characters which were determined in the steps above. You will hear a two-beep indication after the last character.



If you make a mistake before the last character, scan the CANCEL barcode to abort and not save the entry string. You can then start again at the beginning.

NOTE

5. Scan the ENTER/EXIT PROGRAMMING MODE barcode to exit Programming Mode.

This completes the procedure. See [Table 46](#) for some examples of how to set this feature.

Table 46. Source Radio Address Delimiter Character Setting Examples

| STEP | ACTION | EXAMPLES | | | |
|------|---|------------------------|-------------|-------------|-------------|
| 1 | Desired Setting | No delimiter character | , (comma) | - (dash) | / (slash) |
| 2 | Scan ENTER/EXIT PROGRAMMING MODE | | | | |
| 3 | Scan SET SOURCE RADIO ADDRESS DELIMITER CHARACTER | | | | |
| 4 | Scan Two Characters From Appendix E, Keypad | '0' and '0' | '2' and 'C' | '2' and 'D' | '2' AND 'F' |
| 5 | Scan ENTER/EXIT PROGRAMMING MODE | | | | |

Source Radio Address Delimiter Character – cont.

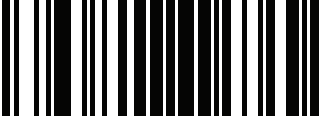
| |
|--|
|  ENTER/EXIT PROGRAMMING MODE |
|--|

| | |
|---|--|
|  Set Source Radio Address Delimiter Character | |
|---|--|

| | |
|--|---|
| Make a mistake? Scan the CANCEL barcode to abort and not save the entry string. You can then start again at the beginning. |  CANCEL |
|--|---|

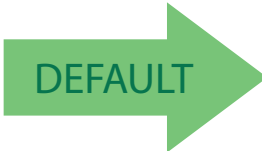
 00 = No Delimiter Character

Appendix A

Technical Specifications

Table 47 contains Physical and Performance Characteristics, User Environment and Regulatory information. Table 48 provides Standard Cable Pinouts.

Table 47. Technical Specifications

| Item | Description |
|--|--|
| Physical Characteristics — Reader | |
| Color | Yellow/Black Black/Black |
| Dimensions | Height 7.5"/190 mm Length 4.5"/115 mm Width 3.0"/75 mm |
| Weight (battery included) | Approximately 13.4 ounces/380 g |
| Physical Characteristics — Base Station | |
| Color | Black/Yellow |
| Dimensions | Height 1.8" (46 mm) — 5.45" (13.84cm) w/antenna Length 9.5" (24.13cm) Width 4.0" (10.16cm) — 4.75" (12.07cm) w/antenna |
| Weight | 12.5 ounces/354 g |
| Electrical Characteristics — Base Station | |
| Input Voltage | 5 VDC +/- 5% 7 – 14 VDC |
| Input Power Maximum Operating Power (charging dead battery) Typical Operating Power (charging full battery) Typical Standby Power | 6.5 W (while charging) 1.4 W 1 W |
| Input Current Maximum Operating Current Typical Operating Current Typical Operating Current (TX data) Typical Standby Current (Idle) | 1300 mA @ 5VDC 250 mA @ 5VDC 210 mA @ 5VDC 115 mA |
| Performance Characteristics | |
| Light Source | Dual LEDs |

| Item | Description |
|---|---|
| Roll (Tilt) Tolerance | ± 30° from normal |
| Pitch Tolerance | ± 82° |
| Skew (Yaw) Tolerance | ± 65° |
| Field of View | 2" wide at 1" from the reader 7" wide at 7" from the reader |
| Depth of Field | 100 mil: typical 5.1" to 208.7" (13 cm to 530 cm) 55 mil: typical 1.9" to 118.1" (4.7 cm to 300 cm) 40 mil: typical 0.8" to 94.5" (2 cm to 240 cm) 20 mil: typical 0.1" to 46.9" (0.3 cm to 119 cm) 13 mil: typical 0" to 31.5" (0.1 cm to 80 cm) 10 mil: typical 0" to 23.6" (0 cm to 60 cm) 7.5 mil: typical 0.1" to 17.3" (0.2 cm to 44 cm) 5 mil: typical 0.6" to 5.5" (1.5 cm to 14 cm) |
| Minimum Element Width | 3 mil |
| Print Contrast Minimum | 15% minimum reflectance |
| Decode Capability | UPC/EAN/JAN, P2 /P5 add-ons; Code 39; Italian Code 32; Code 128; C128 ISBT; Code 128 add-ons; I 2 of 5; Datalogic 2 of 5; Standard 2 of 5; Code 11; Codabar; EAN 128; Code 93; MSI; DataBar Omnidirectional, DataBar Limited, DataBar Expanded. |
| Interfaces Supported | RS-232 Std., RS-232 Wincor-Nixdorf, RS-232 OPOS, IBM 46xx (ports 5B and 9B), USB Com Std., USB Keyboard, USB Alternate Keyboard, USB-OEM, Keyboard Wedge (AT with or w/o Alternate Key, IBM AT PS2 with or w/o Alternate Key, PC-XT, IBM 3153, IBM Terminals 31xx, 32xx, 34xx, 37xx make only and make break keyboard, and Digital Terminals VT2x, VT3xx, VT4xx, and Apple). |
| User Environment — Reader | |
| Operating Temperature | -4° to +122° F (-20° to +50° C) |
| Storage Temperature | -40° to +140° F (-40° to +60° C) |
| Humidity | Operating: 5% to 90% relative humidity, non-condensing Storage: 5% to 95% relative humidity, non-condensing |
| Drop Specifications | 50 drops from 2 meters (6.5 feet) to concrete, -30°C to 50°C |
| Ambient Light Immunity | Up to 100,000 LUX in sunlight. |
| Contaminants Spray/rain Dust/particulates | IEC 529-IPX5 IEC 529-IP6X |
| Beeper Loudness | 84 dBA typical for operator at a distance of 19" (50cm) |

| Item | Description |
|--|---|
| ESD Level | 25 KV |
| User Environment — Base Station & Charger | |
| Contaminants Spray/rain Dust/particulates | IEC 529-IPX4 IEC 529-IP5X |
| Regulatory | |
| Electrical Safety | UL 60950-1, CSA C22.2 No. 60950-1, IEC 60950-1 |
| EMI/RFI | USA FCC Part 15 Class B. Canada ICES-003 Class B. European Union EMC and R&TTE Directives. EN 301 489-17 — Radio Immunity. EN 300 328 v 1.7.1 Radio Emissions. EN 61000 6-2 — Generic Immunity for Industrial Environments. EN 50392 — Human exposure to electromagnetic fields. |
| Laser Safety | Complies with 21 CFR 1040 Class 2 and IEC/EN60825-1:2007 Class II when laser pointer installed. |

Standard Cable Pinouts

Figure 8 and Table 48 provide standard pinout information for the Base Station's cable.

Figure 8. Standard Cable Pinouts

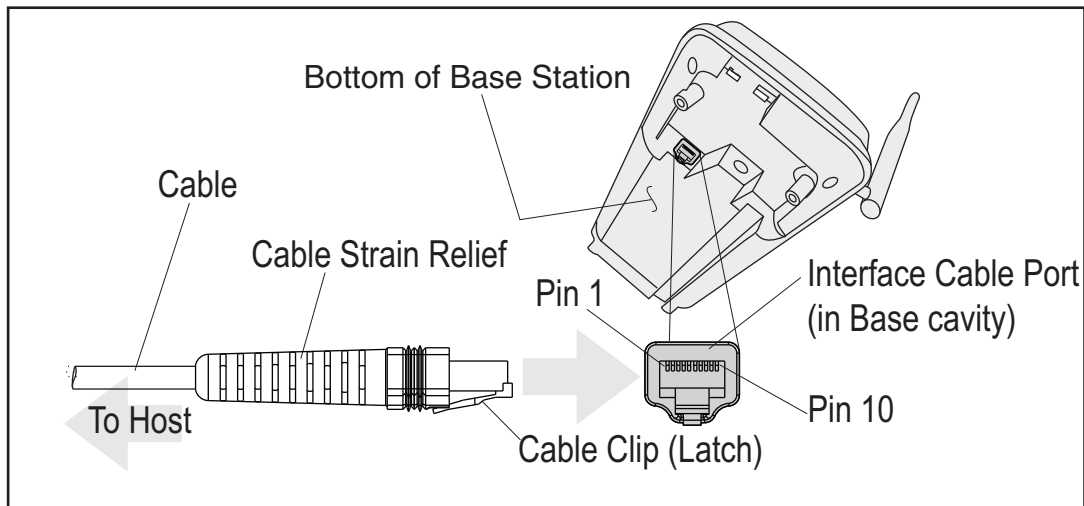

The signal descriptions in Table 48 apply to the connector on the Base Station and are for reference only.

Table 48. Standard Cable Pinouts — Base Station Side

| Pin | RS-232 | OEM | USB | Keyboard Wedge |
|-----|-----------|-------|-----|-------------------|
| 1 | RTS (out) | | | |
| 2 | | | D+ | CLKIN (KBD side) |
| 3 | | | D- | DATAIN (KBD side) |
| 4 | GND | GND | GND | GND |
| 5 | RX | | | |
| 6 | TX | | | |
| 7 | VCC | VCC | VCC | VCC |
| 8 | | IBM_B | | CLKOUT (PC side) |
| 9 | | IBM_A | | DATAOUT (PC side) |
| 10 | CTS (in) | | | |

Appendix B

Standard Defaults

The most common configuration settings are listed in the “Default” column of the table below. Page references are also provided for feature descriptions and programming barcodes for each parameter. A column has also been provided for recording of your preferred default settings for these same configurable features.

Table 49. Standard Defaults

| Parameter | Default | Your Setting | Page Number |
|------------------------------|--|--------------|-------------|
| General Features | | | |
| Double Read Timeout | 0.4 Second | | 19 |
| Label Gone Timeout | 160 ms | | 21 |
| Sleep Mode Timeout | Disable | | 23 |
| Sleep Mode Timeout | Disable | | 23 |
| Power On Alert | 4 Beeps | | 25 |
| Good Read: When to Indicate | After Decode | | 26 |
| Good Read Beep Type | Mono | | 27 |
| Good Read Beep Frequency | High | | 28 |
| Good Read Beep Length | 80 ms | | 28 |
| Good Read Beep Volume | High | | 30 |
| Good Read LED Duration | 2 Seconds | | 31 |
| Scan Mode | Trigger Single | | 33 |
| Stand Mode Triggered Timeout | 0.5 Seconds | | 35 |
| Scanning Active Time | 5 Seconds | | 37 |
| Flash On Time | 1 Second | | 39 |
| Flash Off Time | 600 ms | | 41 |
| Laser Pointer Control | Start scanning immediately after trigger | | 44 |
| Laser Pointer Period | 500 ms | | 45 |

| Parameter | Default | Your Setting | Page Number |
|--|------------------------|--------------|-------------|
| Green Spot Duration | 300 ms | | 46 |
| RS-232 | | | |
| Baud Rate | 9600 | | 47 |
| Data Bits | 8 Data Bits | | 49 |
| Stop Bits | 1 Stop Bit | | 50 |
| Parity | None | | 51 |
| Handshaking Control | Disable | | 52 |
| RS-232/USB-COM | | | |
| RTS/CTS Scan Control — RTS is asserted during transmissions. CTS gates transmissions and controls enable and disable state of scanner. | No Delay | | 52 |
| Beep On ASCII BEL | Disable | | 56 |
| Beep On Not on File | Enable | | 56 |
| ACK Character | 'ACK' | | 58 |
| NAK Character | 'NAK' | | 60 |
| ACK NAK Timeout Value | 600 ms | | 62 |
| ACK NAK Retry Count | 3 Retries | | 64 |
| ACK NAK Error Handling | Ignore Errors Detected | | 66 |
| Indicate Transmission Failure | Enable | | 67 |
| Disable Character | 'D' | | 68 |
| Enable Character | 'E' | | 70 |
| Keyboard Wedge | | | |
| Country Mode | U.S. Keyboard | | 74 |
| Caps Lock State | Caps Lock OFF | | 77 |
| Numlock | Numlock Key Unchanged | | 77 |
| Send Control Characters | Disable | | 78 |
| Wedge Quiet Interval | 100 ms | | 79 |
| Intercharacter Delay | No Delay | | 81 |
| Intercode Delay | No Delay | | 83 |

| Parameter | Default | Your Setting | Page Number |
|------------------------------------|---|--------------|-------------|
| USB Keyboard Speed | 1 ms | | 85 |
| USB-OEM | | | |
| USB-OEM Device Usage | Handheld Reader | | 88 |
| USB-OEM Interface Options | Ignore | | 89 |
| IBM | | | |
| 46xx Number of Host Resets | 6 Host Resets | | 92 |
| Transmit Labels in Code 39 Format | IBM Std Format | | 95 |
| IBM 46XX Interface Options | Ignore | | 96 |
| Wand Emulation | | | |
| Wand Idle State | High | | 97 |
| Wand Polarity | Quiet Zones and Spaces High, Bars Low | | 98 |
| Wand Signal Speed | 660 ms | | 99 |
| Label Symbology Conversion | No Conversion | | 100 |
| Transmit Noise | Disable | | 101 |
| Data Editing | | | |
| Global Prefix/Suffix | No Global Prefix Global Suffix = 0x0D (CR) | | 104 |
| Global AIM ID | Disable | | 106 |
| Label ID Control | Disable | | 114 |
| Case Conversion | Disable | | 123 |
| Character Conversion | No Char Conversion | | 124 |
| Symbologies | | | |
| Coupon Control | Enable only UPC/EAN coupon decoding | | 129 |
| UPC-A | | | |
| UPC-A Enable/Disable | Enable | | 130 |
| UPC-A Check Character Transmission | Enable | | 130 |
| Expand UPC-A to EAN-13 | Don't Expand | | 131 |

| Parameter | Default | Your Setting | Page Number |
|--|--------------|--------------|-------------|
| UPC-A Number System Character Transmission | Transmit | | 131 |
| UPC-A Minimum Reads | 1 | | 149 |
| In-Store Minimum Reads | 2 | | 132 |
| UPC-E | | | |
| UPC-E Enable/Disable | Enable | | 133 |
| UPC-E Check Character Transmission | Send | | 133 |
| Expand UPC-E to EAN-13 | Don't Expand | | 134 |
| Expand UPC-E to UPC-A | Don't Expand | | 134 |
| UPC-E Number System Character Transmission | Transmit | | 135 |
| UPC-E Minimum Reads | 2 | | 136 |
| GTIN | | | |
| GTIN Formatting | Disable | | 137 |
| EAN 13 | | | |
| EAN 13 Enable/Disable | Enable | | 138 |
| EAN 13 Check Character Transmission | Send | | 138 |
| EAN-13 Flag 1 Character | Transmit | | 139 |
| EAN-13 ISBN Conversion | Disable | | 140 |
| ISSN Enable/Disable | Disable | | 140 |
| EAN 13 Minimum Reads | 1 | | 141 |
| EAN 8 | | | |
| EAN 8 Enable/Disable | Enable | | 142 |
| EAN 8 Check Character Transmission | Send | | 142 |
| Expand EAN 8 to EAN 13 | Disable | | 143 |
| EAN 8 Minimum Reads | 1 | | 144 |
| UPC/EAN Global Settings | | | |
| UPC/EAN Decoding Level | 3 | | 145 |
| UPC/EAN Correlation | Disable | | 147 |
| UPC/EAN Reconstruction | Disable | | 147 |

| Parameter | Default | Your Setting | Page Number |
|---|-----------------------|--------------|-------------|
| UPC/EAN Price Weight Check | Disable | | 148 |
| Add-Ons | | | |
| Optional Add-ons | Disable P2, P5 and P8 | | 150 |
| Optional Add-On Timer | 70 ms | | 152 |
| Optional GS1-128 Add-On Timer | Disable | | 155 |
| P2 Add-Ons Minimum Reads | 2 | | 158 |
| P5 Add-Ons Minimum Reads | 1 | | 159 |
| GS1-128 Add-Ons Minimum Reads | 1 | | 160 |
| DataBar Omnidirectional | | | |
| GS1 DataBar Omnidirectional Enable/Disable | Disable | | 161 |
| GS1 DataBar Omnidirectional GS1-128 Emulation | Disable | | 161 |
| GS1 DataBar Omnidirectional Minimum Reads | 1 | | 162 |
| DataBar Expanded | | | |
| GS1 DataBar Expanded Enable/Disable | Disable | | 163 |
| GS1 DataBar Expanded GS1-128 Emulation | Disable | | 163 |
| GS1 DataBar Expanded Minimum Reads | 1 | | 164 |
| GS1 DataBar Expanded Length Control | Variable | | 165 |
| GS1 DataBar Expanded Set Length 1 | 1 | | 166 |
| GS1 DataBar Expanded Set Length 2 | 74 | | 168 |
| DataBar Limited | | | |
| GS1 DataBar Limited Enable/Disable | Disable | | 170 |
| GS1 DataBar Limited GS1-128 Emulation | Disable | | 170 |
| GS1 DataBar Limited Minimum Reads | 1 | | 171 |
| Code 39 | | | |
| Code 39 Enable/Disable | Enable | | 172 |
| Code 39 Check Character Calculation | Calculate | | 173 |

| Parameter | Default | Your Setting | Page Number |
|---|----------------|--------------|-------------|
| Code 39 Check Character Transmission | Send | | 174 |
| Code 39 Start/Stop Character Transmission | Don't Transmit | | 174 |
| Code 39 Full ASCII | Disable | | 175 |
| Code 39 Quiet Zones | Auto | | 176 |
| Code 39 Minimum Reads | 1 | | 177 |
| Code 39 Decoding Level | 3 | | 178 |
| Code 39 Length Control | Variable | | 180 |
| Code 39 Set Length 1 | 2 | | 181 |
| Code 39 Set Length 2 | 50 | | 183 |
| Code 39 Interdigit Ratio | 4 | | 185 |
| Code 39 Character Correlation | Disable | | 187 |
| Code 39 Stitching | Enable | | 188 |
| Code 32 | | | |
| Code 32 Enable/Disable | Disable | | 189 |
| Code 32 Feature Setting Exceptions | 3 | | 189 |
| Code 32 Check Character Transmission | Don't Send | | 190 |
| Code 32 Start/Stop Character Transmission | Don't Transmit | | 190 |
| Code 39 CIP (French Pharmaceutical) | | | |
| Code 39 CIP Enable/Disable | Disable | | 191 |
| Code 128 | | | |
| Code 128 Enable/Disable | Enable | | 191 |
| Expand Code 128 to Code 39 | Don't Expand | | 192 |
| Code 128 Check Character Transmission | Send | | 192 |
| Code 128 Quiet Zones | Auto | | 195 |
| Code 128 Minimum Reads | 1 | | 196 |
| Code 128 Decoding Level | 3 | | 197 |
| Code 128 Length Control | Variable | | 199 |
| Code 128 Set Length 1 | 1 | | 200 |

| Parameter | Default | Your Setting | Page Number |
|--|----------------------------------|--------------|-------------|
| Code 128 Set Length 2 | 80 | | 202 |
| Code 128 Character Correlation | Disable | | 204 |
| Code 128 Stitching | Enable | | 205 |
| UCC-EAN 128 | | | |
| GS1-128 Enable | Transmit in Code 128 Data Format | | 206 |
| ISBT 128 | | | |
| ISBT 128 Concatenation | Disable | | 288 |
| ISBT 128 Concatenation Mode | Static | | 289 |
| ISBT 128 Dynamic Concatenation Time-out | 200 ms | | 290 |
| ISBT 128 Force Concatenation | Enable | | 291 |
| ISBT 128 Advanced Concatenation Options | Disable | | 291 |
| Interleaved 2 of 5 | | | |
| I 2 of 5 Enable/Disable | Enable | | 207 |
| I 2 of 5 Check Character Calculation | Disable | | 208 |
| I 2 of 5 Check Character Transmission | Send | | 209 |
| I 2 of 5 Minimum Reads | 1 | | 222 |
| I 2 of 5 Decoding Level | 3 | | 211 |
| I 2 of 5 Length Control | Variable | | 213 |
| I 2 of 5 Set Length 1 | 12 | | 214 |
| I 2 of 5 Set Length 2 | 100 | | 216 |
| I 2 of 5 Character Correlation | Disable | | 218 |
| I 2 of 5 Stitching | Disable | | 219 |
| Interleaved 2 of 5 CIP HR | | | |
| Interleaved 2 of 5 CIP HR Enable/Disable | Disable | | 220 |
| Datalogic 2 of 5 | | | |
| Datalogic 2 of 5 Enable/Disable | Enable | | 220 |
| Datalogic 2 of 5 Check Character Calculation | Disable | | 221 |

| Parameter | Default | Your Setting | Page Number |
|---|---------------------|--------------|-------------|
| Datalogic 2 of 5 Minimum Reads | 1 | | 222 |
| Datalogic 2 of 5 Length Control | Variable | | 223 |
| Datalogic 2 of 5 Set Length 1 | 12 | | 224 |
| Datalogic 2 of 5 Set Length 2 | 100 | | 226 |
| Datalogic 2 of 5 Character Correlation | Disable | | 230 |
| Datalogic 2 of 5 Stitching | Disable | | 231 |
| Codabar | | | |
| Codabar Enable/Disable | Disable | | 232 |
| Codabar Check Character Calculation | Don't Calculate | | 233 |
| Codabar Check Character Transmission | Send | | 234 |
| Codabar Start/Stop Character Transmission | Transmit | | 234 |
| Codabar Start/Stop Character Set | abcd/abcd | | 235 |
| Codabar Start/Stop Character Match | Don't Require Match | | 236 |
| Codabar Quiet Zones | Auto | | 237 |
| Codabar Minimum Reads | 1 | | 238 |
| Codabar Decoding Level | 3 | | 239 |
| Codabar Length Control | Variable | | 241 |
| Codabar Set Length 1 | 3 | | 242 |
| Codabar Set Length 2 | 50 | | 244 |
| Codabar Interdigit Ratio | 4 | | 246 |
| Codabar Character Correlation | Disable | | 248 |
| Codabar Stitching | Disable | | 249 |
| ABC Codabar | | | |
| ABC Codabar Enable/Disable | Disable | | 250 |
| ABC Codabar Concatenation Mode | Static | | 250 |
| ABC Codabar Dynamic Concatenation Timeout | 200ms | | 251 |
| ABC Codabar Force Concatenation | Disable | | 252 |
| Code 11 | | | |
| Code 11 Enable/Disable | Disable | | 253 |

| Parameter | Default | Your Setting | Page Number |
|--|---------------|--------------|-------------|
| Code 11 Check Character Calculation | Check C and K | | 254 |
| Code 11 Check Character Transmission | Send | | 255 |
| Code 11 Minimum Reads | 1 | | 256 |
| Code 11 Length Control | Variable | | 257 |
| Code 11 Set Length 1 | 4 | | 258 |
| Code 11 Set Length 2 | 50 | | 260 |
| Code 11 Interdigit Ratio | 4 | | 262 |
| Code 11 Decoding Level | 3 | | 264 |
| Code 11 Character Correlation | Disable | | 266 |
| Code 11 Stitching | Disable | | 267 |
| Standard 2 of 5 | | | |
| Standard 2 of 5 Enable/Disable | Disable | | 268 |
| Standard 2 of 5 Check Character Calculation | Disable | | 269 |
| Standard 2 of 5 Check Character Transmission | Send | | 269 |
| Standard 2 of 5 Minimum Reads | 1 | | 270 |
| Standard 2 of 5 Decoding Level | 3 | | 270 |
| Standard 2 of 5 Length Control | Variable | | 271 |
| Standard 2 of 5 Set Length 1 | 8 | | 272 |
| Standard 2 of 5 Set Length 2 | 50 | | 274 |
| Standard 2 of 5 Character Correlation | Disable | | 276 |
| Standard 2 of 5 Stitching | Disable | | 277 |
| Industrial 2 of 5 | | | |
| Industrial 2 of 5 Enable/Disable | Disable | | 278 |
| Industrial 2 of 5 Check Character Calculation | Disable | | 278 |
| Industrial 2 of 5 Check Character Transmission | Enable | | 279 |
| Industrial 2 of 5 Length Control | Variable | | 280 |
| Industrial 2 of 5 Set Length 1 | 1 Char | | 281 |

| Parameter | Default | Your Setting | Page Number |
|---|---|--------------|-------------|
| Industrial 2 of 5 Set Length 2 | 50 Chars | | 283 |
| Industrial 2 of 5 Minimum Reads | 1 Read | | 285 |
| Industrial 2 of 5 Stitching | Disable | | 286 |
| Industrial 2 of 5 Character Correlation | Disable | | 286 |
| IATA | | | |
| IATA Enable/Disable | Disable | | 287 |
| IATA Check Character Transmission | Enable | | 287 |
| ISBT 128 | | | |
| ISBT 128 Concatenation | Disable | | 288 |
| ISBT 128 Concatenation Mode | Static | | 289 |
| ISBT 128 Dynamic Concatenation Time-out | 200 ms | | 290 |
| ISBT 128 Force Concatenation | Disable | | 291 |
| ISBT 128 Advanced Concatenation Options | Disable | | 291 |
| MSI | | | |
| MSI Enable/Disable | Disable | | 292 |
| MSI Check Character Calculation | Enable Mod 10 | | 293 |
| MSI Check Character Transmission | Enable | | 294 |
| MSI Length Control | Variable | | 294 |
| MSI Set Length 1 | 1 Char | | 295 |
| MSI Set Length 2 | 50 Chars | | 297 |
| MSI Minimum Reads | 4 Reads | | 299 |
| MSI Decoding Level | Level 3 | | 300 |
| Plessey | | | |
| Plessey Enable/Disable | Disable | | 302 |
| Plessey Check Character Calculation | Enable Plessey Std and Anker Check Verification | | 303 |
| Plessey Check Character Transmission | Enable | | 304 |
| Plessey Length Control | Variable | | 304 |

| Parameter | Default | Your Setting | Page Number |
|--------------------------------------|----------------------|--------------|-------------|
| Plessey Set Length 1 | 1 Char | | 305 |
| Plessey Set Length 2 | 50 Chars | | 307 |
| Plessey Minimum Reads | 4 Reads | | 309 |
| Plessey Decoding Level | Level 3 | | 310 |
| Plessey Stitching | Disable | | 311 |
| Plessey Character Correlation | Disable | | 312 |
| Code 93 | | | |
| Code 93 Enable/Disable | Disable | | 312 |
| Code 93 Check Character Calculation | Enable Check C and K | | 313 |
| Code 93 Check Character Transmission | Enable | | 314 |
| Code 93 Length Control | Variable | | 314 |
| Code 93 Set Length 1 | 1 Char | | 315 |
| Code 93 Set Length 2 | 50 Chars | | 317 |
| Code 93 Minimum Reads | 1 Read | | 319 |
| Code 93 Decoding Level | Level 3 | | 320 |
| Code 93 Quiet Zones | Auto | | 322 |
| Code 93 Stitching | Enable | | 323 |
| Code 93 Character Correlation | Enable | | 323 |
| Codablock F | | | |
| Codablock F Enable/Disable | Enable | | 324 |
| Codablock F EAN Enable/Disable | Disable | | 325 |
| Codablock F AIM Check | Enable Check C | | 325 |
| Codablock F Length Control | Variable | | 326 |
| Codablock F Set Length 1 | 3 Chars | | 327 |
| Codablock F Set Length 2 | 100 Chars | | 329 |
| Code 4 | | | |
| Code 4 Enable/Disable | Disable | | 331 |
| Code 4 Check Character Transmission | Don't Send | | 332 |
| Code 4 Hex to Decimal Conversion | Enable | | 332 |

| Parameter | Default | Your Setting | Page Number |
|--|--------------|--------------|-------------|
| Code 5 | | | |
| Code 5 Enable/Disable | Disable | | 333 |
| Code 5 Check Character Transmission | Send | | 334 |
| Code 5 Hex to Decimal Conversion | Enable | | 334 |
| Code 4 and Code 5 Common Configuration Items | | | |
| Code 4 and 5 Decoding Level | 3 | | 335 |
| Code 4 and Code 5 Minimum Reads | 1 | | 337 |
| Follett 2 of 5 | | | |
| Follett 2 of 5 Enable/Disable | Disable | | 338 |
| BT Features | | | |
| ACK Beep | Enable | | 340 |
| Beep Frequency | Low | | 341 |
| Beep Duration | 80 ms | | 342 |
| Beep Volume | High | | 344 |
| BT Base Station Beep | Disable | | 345 |
| Disconnect Beep | Enable | | 345 |
| BT Leash Alarm | Enable | | 346 |
| BT Leash Alarm | Disable | | 346 |
| BT Automatic Flash Update | Disable | | 348 |
| Automatic Configuration Update | Enable | | 349 |
| Battery Charge Mode | Low Charge | | 351 |
| Powerdown Timeout | Disable | | |
| BT Poll Rate | Wait Forever | | 354 |
| BT Poll Rate | 2 Seconds | | 354 |
| BT Poll Rate | 20 ms | | 354 |
| Batch Mode | Disable | | 356 |
| BT Batch Mode Transmit Delay | No Delay | | 358 |
| BT Pin Code | 1234 | | 359 |
| BT Security Mode | Disable | | 362 |

| Parameter | Default | Your Setting | Page Number |
|---|--|--------------|-------------|
| Optional: Linking a PowerScan 7000 Reader to a PBT7100 Base Station | Disable | | 363 |
| BT Address Stamping | Send HACK as soon as the Base Station receives a label | | 364 |
| Source Radio Address Transmission | Do Not Include | | 364 |
| Source Radio Address Delimiter Character | No Delimiter Character | | 365 |

NOTES

Appendix C

LED and Beeper Indications

The reader's beeper sounds and its LED illuminates to indicate various functions or errors on the reader. An optional "Green Spot" also performs useful functions. The tables below list these indications. One exception to the behaviors listed in the tables is that the reader's functions are programmable, and may or may not be turned on. For example, certain indications, such as the power-up beep can be disabled using programming barcode labels.

General Functions — LED and Beeper Indications

| INDICATION | DESCRIPTION | LED | BEEPER |
|---|--|--|--|
| Power-up Beep | The reader is in the process of powering-up. | | Reader beeps four times at highest frequency and volume upon power-up. |
| Good Read Beep | A label has been successfully scanned by the reader. | LED behavior for this indication is configurable via the feature “Good Read: When to Indicate” | The reader will beep once at current frequency, volume, mono/bi-tonal setting and duration upon a successful label scan. |
| ROM Failure | There is an error in the reader's software/programming | Flashes | Reader sounds one error beep at highest volume. |
| Limited Scanning Label Read | Indicates that a host connection is not established when the IBM or USB interface is enabled. | N/A | Reader 'chirps' six times at the highest frequency and current volume. |
| Reader Active Mode | The reader is active and ready to scan. | The LED is lit steadily ^a | N/A |
| Reader Disabled | The reader has been disabled by the host. | The LED blinks continuously | N/A |
| Green Spot is on continuously | While in Object Sense mode or Trigger Object Sense mode the green spot shall be on while in stand watch state. | N/A | N/A |
| Green Spot ^a flashes momentarily | Upon successful read of a label, the software shall turn the green spot on for the time specified by the configured value. | N/A | N/A |

Programming Mode - The following indications ONLY occur when the reader is in Programming Mode.

| | | | |
|--|---|-------------------------|--|
| Label Programming Mode Entry | A valid programming label has been scanned. | LED blinks continuously | Reader sounds four low frequency beeps. |
| Label Programming Mode Rejection of Label | A label has been rejected. | N/A | Reader sounds three times at lowest frequency & current volume. |
| Label Programming Mode Acceptance of Partial Label | In cases where multiple labels must be scanned to program one feature, this indication acknowledges each portion as it is successfully scanned. | N/A | Reader sounds one short beep at highest frequency & current volume. |
| Label Programming Mode Acceptance of Programming | Configuration option(s) have been successfully programmed via labels and the reader has exited Programming Mode. | N/A | Reader sounds one high frequency beep and 4 low frequency beeps followed by reset beeps. |
| Label Programming Mode Cancel Item Entry | Cancel label has been scanned. | N/A | Reader sounds two times at low frequency and current volume. |

^a. Except when in sleep mode or when a Good Read LED Duration other than 00 is selected

BT Beeper Indications

| Beep Type | Description | Behavior |
|-------------------------|--|---|
| Acknowledge (ACK) Label | A label has been sent to the Base Station, which has accepted the data and responded. Control via ACK NAK Options on page 57 . | 1 beep. Duration, frequency and volume vary, since these are all configurable for this feature. |
| Label Rejected | Label data sent is rejected by the Base Station (responds with NAK). Control via ACK NAK Options on page 57 . | 2 beeps at low frequency. |
| Transmission Error | A label has been sent to but not received by the Base Station (ACK timeout occurred). Control via Indicate Transmission Failure on page 67 . | Beep will sound High-low-high-low. |
| Link Successful | The Linking process has completed successfully between a reader and Base Station (or PC). | Beep will sound Low-med-high. |
| Link Unsuccessful | The Linking process has completed (timed out) without connecting to a Base (or PC). | Beep will sound High-low-high-low. |
| Unlink | The reader has unlinked from the Base Station. | Beep will sound High-medium-low. |
| Paging | Base Station is paging the reader. | 5 beeps at high volume and current Good Read Beep Frequency setting. |
| BT Reader FRU | The reader will sound this upon detecting a Field Replaceable Unit (FRU) error at startup. | 1 long error tone ^a . |
| Disconnect | Sounds when the reader disconnects from the Base Station due to out of range, low power, etc. Control via Disconnect Beep on page 345 . | Beep will sound High-medium-low. (Same as Unlink) |
| Good Read Disconnected | A label is read while disconnected, and BT Poll Rate on page 354 is disabled. | 1 long beep at low frequency. |
| Good Read Unlinked | A label is read while unlinked. | Beep will sound High-low-high-low. |
| Leash mode | The Handheld has disconnected, and BT Leash Alarm on page 346 is enabled. | Beep will sound at high volume, low frequency for the count specified in BT Leash Alarm on page 346 . |
| Low Battery | The battery is getting low | 10 beeps at high frequency |
| Battery Shutdown | The battery has reached a critical low level and the handheld will shut down. | Beep will sound High-medium-low |

^a. Upon hearing a long error tone at startup, press the trigger to hear the FRU error beep sequence described in [Error Codes on page 389](#).

BT LED Indications

| LED Indication | Behavior | Applies to: | |
|--------------------------------|---|--------------|--------|
| | | Base Station | Reader |
| Linking in progress | Yellow LED blinks at 2 Hz | YES | YES |
| Low battery | Green LED blinks 10 times after either of the following events occur: <ul style="list-style-type: none"> -After every 10th trigger pull. -After 30 seconds of idle time. NOTE: Low battery LED indication coincides with the low battery beep. | NO | YES |
| Disconnected | LEDs off | YES | YES |
| Unlinked | LEDs off | YES | YES |
| BT transmission in progress | Flash yellow LED at 50 Hz while transmitting. | YES | YES |
| Paging | Yellow LED blinks at the same rate as the paging beep (1 hz) | YES | YES |
| BT Reader FRU indication | See the topic Error Codes on page 389 . | NO | YES |
| BT Base Station FRU indication | See the topic Error Codes on page 389 . | YES | NO |
| Disabled indication | Green LED blinks once a second while disabled | NO | YES |
| Battery charge in progress | Green LED blinks once a second while charging | YES | NO |
| Battery charge complete | Green LED stays ON when charge is complete and reader is seated in the Base Station. | YES | NO |
| Battery charge error | Yellow LED blinks 550mS on/1500mS off when there is a charge error and reader is seated in the Base Station. | YES | NO |

Error Codes

Upon startup, if the reader sounds a long tone, this means the reader has not passed its automatic Selftest and has entered FRU¹ isolation mode. If the reader is reset, the sequence will be repeated. The following table describes the LED flashes/beep codes associated with an error found.

| NUMBER OF LED FLASHES/BEEPS | ERROR | CORRECTIVE ACTION |
|-----------------------------|--------------------------------|---------------------------------|
| 1 | Configuration | Contact Helpdesk for assistance |
| 2 | Interface PCB | |
| 4 | Reader Module | |
| 5 | Laser Pointer (if so equipped) | |
| 6 | Digital PCB | |
| 14 | CPLD/Code Mismatch | |

1. Field Replaceable Unit (FRU)

NOTES

Appendix D

Sample Barcodes

The sample barcodes in this appendix are typical representations for their symbology types.



UPC-A

EAN-13



Code 39

Code 128



Interleaved 2 of 5

Sample Barcodes — continued

Code 32



00246897634



5765485

Codabar

Code 93



7554628485

Code 11

MSI



74759330108

DataBar (RSS)



DataBar variants must be enabled to read the barcodes below (see [DataBar \(RSS\)](#) on page 393).

NOTE



10293847560192837465019283746029478450366523
(DataBar Expanded Stacked)



1234890hjio9900mnb
(DataBar Expanded)



08672345650916
(DataBar Limited)

DataBar-14



55432198673467
(DataBar Omnidirectional Truncated)



90876523412674
(DataBar Omnidirectional Stacked)









78123465709811
(DataBar Omnidirectional Stacked)





NOTES

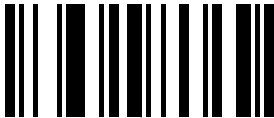
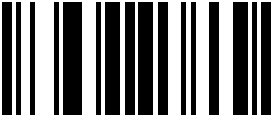

Appendix E

Keypad

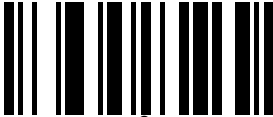
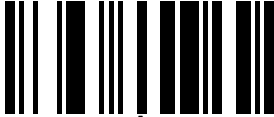
Use the barcodes in this appendix to enter numbers as you would select digits/characters from a keypad.

| | |
|--|--|
|  0 | |
| |  1 |
|  2 | |
| |  3 |
|  4 | |
| |  5 |

| | |
|--|---|
|  <p>6</p> | |
| |  <p>7</p> |
|  <p>8</p> | |
| |  <p>9</p> |
|  <p>A</p> | |
| |  <p>B</p> |
|  <p>C</p> | |

| | |
|--|--|
| |  D |
|  E | |
| |  F |

NOTES

Appendix F

Scancode Tables

Control Character Emulation

Control character emulation selects from different scancode tables as listed in this appendix. Each of the control character sets below are detailed by interface type in the tables. These apply to Wedge and USB Keyboard platforms.

Control Character 00 . Characters from 00 to 0x1F are sent as control character Ctrl+Keys, special keys are located from 0x80 to 0xA1.

Control Character 01 . Characters from 00 to 0x1F are sent as control character Ctrl+Capital Key, special keys are located from 0x80 to 0xA1.

Control Character 02 . Special keys are located from 00 to 0x1F and characters from 0x80 to 0xFE are intended as an extended ASCII table ([Microsoft Windows Codepage 1252 on page 410](#))

Single Press and Release Keys

In the following tables, Ar↓ means Alt right pressed and Ar↑ means Alt right released and so on. Definitions for other keys are Al (Alt left), Cr (Control Right) Cl (Control Left) Sh (shift). This method can be used for combining Alt, Control or Shift with other keys.

Example: Consider a Control character set to 00. If AltRight+A is required before sending a label to the host, it could be done by setting three Prefix keys in this way: 0x99 0x41 0x9A.

Interface Type PC AT PS/2 or USB-Keybaord

Table F-1. Scancode Set When Control Character is 00 or 01

| | x0 | x1 | x2 | x3 | x4 | x5 | x6 | x7 | x8 | x9 | xA | xB | xC | xD | xE | xF |
|----|---------------|---------------|---------------|---------------|---------------|---------------|---------------|---------------|---------------|--------------|---------------|--------------|--------------|-------------|--------------|--------------|
| 0x | NULL C+@ | SOH C(S)+A | STX C(S)+B | ETX C(S)+C | EOT C(S)+D | ENQ C(S)+E | ACK C(S)+F | BEL C(S)+G | BS C(S)+X | HT TAB | LF C(S)+J | VT C(S)+K | FF C(S)+L | CR Enter | SO C(S)+N | SI C(S)+O |
| 1x | DLE C(S)+P | DC1 C(S)+Q | DC2 C(S)+R | DC3 C(S)+S | DC4 C(S)+T | NAK C(S)+U | SYN C(S)+V | ETB C(S)+W | CAN C(S)+X | EM C(S)+Y | SUB C(S)+Z | ESC Esc | FS C+1 | GS C+] | RS C+^ | US C(S)+_ |
| 2x | <u>SP</u> | 1 | 2 | 3 | 4 | % | & | : | (|) | * _ | ± | • | = | • | / |
| 3x | 0 | 1 | 2 | 3 | 4 | 5 | 6 | 7 | 8 | 9 | : | ; | ≤ | ≡ | ≥ | ? |
| 4x | @ | A | B | C | D | E | F | G | H | I | J | K | L | M | N | O |
| 5x | P | Q | R | S | T | U | V | W | X | Y | Z | [|] | ^ | _ | - |
| 6x | : | a | b | c | d | e | f | g | h | i | j | k | l | m | n | o |
| 7x | p | q | r | s | t | u | v | w | x | y | z | { | } | ~ | Del | |
| 8x | € | Sh↓ | Sh↑ | Ins | Ent (keyp) | F1 | F2 | F3 | F4 | F5 | F6 | F7 | F8 | F9 | F10 | F11 |
| 9x | F12 | Home | End | Pg Up | Pg Dwn | ↑ | ↓ | ← | → | Ar↑ | Ar↓ | Alt↓ | Alt↑ | Cl↓ | Cl↑ | Cr↓ |
| Ax | Cr↑ | □ | ‘ | f | ” | … | † | ‡ | • | % | § | ◀ | § | ◀ | œ | □ |
| Bx | ° | ± | ˆ | ˙ | ˚ | μ | ¶ | · | ˘ | ˚ | ° | » | ¼ | ¼ | ¼ | ¿ |
| Cx | Á | À | Ä | Å | Ä | Å | Æ | Ç | È | É | Ê | Ë | Ì | Í | Î | Ï |
| Dx | Ð | Ñ | Ó | Ô | Õ | Ö | Ø | × | Ù | Ú | Û | Ü | Ý | Þ | ß | |
| Ex | à | á | â | ã | ä | å | æ | ç | è | é | ê | ë | ì | í | î | ï |
| Fx | ø | ñ | ò | ó | ô | õ | ö | ÷ | ø | ù | ú | û | ü | ý | þ | ÿ |

Extended characters (sky blue) are sent through dedicated keys (when available in the selected country mode) or by using an Alt Mode sequence.

Interface Type PC AT PS/2 or USB-KeyBoard – cont.

Table F-2. Scancode Set When Control Character is 02

| | x0 | x1 | x2 | x3 | x4 | x5 | x6 | x7 | x8 | x9 | xA | xB | xC | xD | xE | xF |
|----|--------|------|-----|-----|-----|-----|-----|-----|----|-----|----|--------|-------------|-------|-----|-------|
| 0x | Ar↓ | Ar↑ | All | Al↑ | Cl↓ | Cl↑ | Cr↓ | Cr↑ | BS | Tab | → | S+ Tab | Enter Keypd | Enter | Ins | Pg Up |
| 1x | Pg Dwn | Home | ← | ↓ | ↑ | F6 | F1 | F2 | F3 | F4 | F5 | ESC | F7 | F8 | F9 | F10 |
| 2x | Space | ! | " | # | \$ | % | & | ' | (|) | * | + | , | - | . | / |
| 3x | 0 | 1 | 2 | 3 | 4 | 5 | 6 | 7 | 8 | 9 | : | ; | < | = | > | ? |
| 4x | @ | A | B | C | D | E | F | G | H | I | J | K | L | M | N | O |
| 5x | P | Q | R | S | T | U | V | W | X | Y | Z | [| \ |] | ^ | _ |
| 6x | , | a | b | c | d | e | f | g | h | i | j | k | l | m | n | o |
| 7x | p | q | r | s | t | u | v | w | x | y | z | { | | } | ~ | Del |
| 8x | € | □ | ' | f | " | ... | † | ‡ | · | % | S | < | S | < | Œ | □ |
| 9x | □ | ' | ' | " | " | • | - | — | ~ | ™ | § | > | œ | □ | ž | Y |
| Ax | NBSP | ¡ | ¢ | £ | ¤ | ¥ | ¦ | § | ¨ | © | ª | « | ¬ | ­ | ® | ¯ |
| Bx | ° | ± | ² | ³ | ´ | µ | ¶ | · | ¸ | ¹ | º | » | ¼ | ½ | ¾ | ¿ |
| Cx | À | Á | Â | Ã | Ä | Å | Æ | Ç | È | É | Ê | Ë | Ì | Í | Î | Ï |
| Dx | Ð | Ñ | Ò | Ó | Ô | Õ | Ö | × | Ø | Ù | Ú | Û | Ü | Ý | Þ | ß |
| Ex | à | á | â | ã | ä | å | æ | ç | è | é | ê | ë | ì | í | î | ï |
| Fx | ð | ñ | ò | ó | ô | õ | ö | ÷ | ø | ù | ú | û | ü | ý | þ | ÿ |

Interface type PC AT PS/2 Alt Mode or USB-Keyboard Alt Mode

Table F-3. Scancode Set When Control Character is 00 or 01

| | x0 | x1 | x2 | x3 | x4 | x5 | X6 | x7 | x8 | x9 | xA | xB | xC | xD | xE | Xf |
|----|---------|---------|---------|---------|---------------|---------|---------|---------|---------|-----------|---------|------------|---------|-------------|---------|---------|
| 0x | Alt+000 | Alt+001 | Alt+002 | Alt+003 | Alt+004 | Alt+005 | Alt+006 | Alt+007 | BS | HT TAB | Alt+010 | Alt+011 | Alt+012 | CR Enter | Alt+014 | Alt+015 |
| 1x | Alt+016 | Alt+017 | Alt+018 | Alt+019 | Alt+020 | Alt+021 | Alt+022 | Alt+023 | Alt+024 | Alt+025 | Alt+026 | ESC Esc | Alt+028 | Alt+029 | Alt+030 | Alt+031 |
| 2x | A+032 | A+033 | A+034 | A+035 | A+036 | A+037 | A+038 | A+039 | A+040 | A+041 | A+042 | A+043 | A+044 | A+045 | A+046 | A+047 |
| 3x | A+048 | A+049 | A+050 | A+051 | A+052 | A+053 | A+054 | A+055 | A+056 | A+057 | A+058 | A+059 | A+060 | A+061 | A+062 | A+063 |
| 4x | A+064 | A+065 | A+066 | A+067 | A+068 | A+069 | A+070 | A+071 | A+072 | A+073 | A+074 | A+075 | A+076 | A+077 | A+078 | A+079 |
| 5x | A+080 | A+081 | A+082 | A+083 | A+084 | A+085 | A+086 | A+087 | A+088 | A+089 | A+090 | A+091 | A+092 | A+093 | A+094 | A+095 |
| 6x | A+096 | A+097 | A+098 | A+099 | A+100 | A+101 | A+102 | A+103 | A+104 | A+105 | A+106 | A+107 | A+108 | A+109 | A+110 | A+111 |
| 7x | A+112 | A+113 | A+114 | A+115 | A+116 | A+117 | A+118 | A+119 | A+120 | A+121 | A+122 | A+123 | A+124 | A+125 | A+126 | A+127 |
| 8x | € | Sh↓ | Sh↑ | Ins | Ent (keyp) | F1 | F2 | F3 | F4 | F5 | F6 | F7 | F8 | F9 | F10 | F11 |
| 9x | F12 | Home | End | Pg Up | Pg Dwn | ↕ | ↘ | ← | → | Ar↓ | Ar↑ | All | Alt↑ | Ctrl↓ | Ctrl↑ | Cr↓ |
| Ax | Cr↑ | A+0161 | A+0162 | A+0163 | A+0164 | A+0165 | A+0166 | A+0167 | A+0168 | A+0169 | A+0170 | A+0171 | A+0172 | A+0173 | A+0174 | A+0175 |
| Bx | A+0176 | A+0177 | A+0178 | A+0179 | A+0180 | A+0181 | A+0182 | A+0183 | A+0184 | A+0185 | A+0186 | A+0187 | A+0188 | A+0189 | A+0190 | A+0191 |
| Cx | A+0192 | A+0193 | A+0194 | A+0195 | A+0196 | A+0197 | A+0198 | A+0199 | A+0200 | A+0201 | A+0202 | A+0203 | A+0204 | A+0205 | A+0206 | A+0207 |
| Dx | A+0208 | A+0209 | A+0210 | A+0211 | A+0212 | A+0213 | A+0214 | A+0215 | A+0216 | A+0217 | A+0218 | A+0219 | A+0220 | A+0221 | A+0222 | A+0223 |
| Ex | A+0224 | A+0225 | A+0226 | A+0227 | A+0228 | A+0229 | A+0230 | A+0231 | A+0232 | A+0233 | A+0234 | A+0235 | A+0236 | A+0237 | A+0238 | A+0239 |
| Fx | A+0240 | A+0241 | A+0242 | A+0243 | A+0244 | A+0245 | A+0246 | A+0247 | A+0248 | A+0249 | A+0250 | A+0251 | A+0252 | A+0253 | A+0254 | A+0255 |

Interface type PC AT PS/2 Alt Mode or USB-Keyboard Alt Mode – cont.

Table F-4. Scancode Set When Control Character is 02

| | x0 | x1 | x2 | x3 | x4 | x5 | X6 | x7 | x8 | x9 | xA | xB | xC | xD | xE | xF |
|----|--------|--------|--------|--------|--------|--------|--------|--------|--------|--------|--------|--------|--------------|--------|--------|--------|
| 0x | Ar↓ | Ar↑ | All | Al↑ | Cl↓ | Cl↑ | Cr↓ | Cr↑ | BS | Tab | → | S+ Tab | Enter Keyprd | Enter | Ins | Pg Up |
| 1x | Pg Dwn | Home | ← | ↓ | ↑ | F6 | F1 | F2 | F3 | F4 | F5 | ESC | F7 | F8 | F9 | F10 |
| 2x | A+032 | A+033 | A+034 | A+035 | A+036 | A+037 | A+038 | A+039 | A+040 | A+041 | A+042 | A+043 | A+044 | A+045 | A+046 | A+047 |
| 3x | A+048 | A+049 | A+050 | A+051 | A+052 | A+053 | A+054 | A+055 | A+056 | A+057 | A+058 | A+059 | A+060 | A+061 | A+062 | A+063 |
| 4x | A+064 | A+065 | A+066 | A+067 | A+068 | A+069 | A+070 | A+071 | A+072 | A+073 | A+074 | A+075 | A+076 | A+077 | A+078 | A+079 |
| 5x | A+080 | A+081 | A+082 | A+083 | A+084 | A+085 | A+086 | A+087 | A+088 | A+089 | A+090 | A+091 | A+092 | A+093 | A+094 | A+095 |
| 6x | A+096 | A+097 | A+098 | A+099 | A+100 | A+101 | A+102 | A+103 | A+104 | A+105 | A+106 | A+107 | A+108 | A+109 | A+110 | A+111 |
| 7x | A+112 | A+113 | A+114 | A+115 | A+116 | A+117 | A+118 | A+119 | A+120 | A+121 | A+122 | A+123 | A+124 | A+125 | A+126 | A+127 |
| 8x | A+0128 | A+0129 | A+0130 | A+0131 | A+0132 | A+0133 | A+0134 | A+0135 | A+0136 | A+0137 | A+0138 | A+0139 | A+0140 | A+0141 | A+0142 | A+0143 |
| 9x | A+0144 | A+0145 | A+0146 | A+0147 | A+0148 | A+0149 | A+0150 | A+0151 | A+0152 | A+0153 | A+0154 | A+0155 | A+0156 | A+0157 | A+0158 | A+0159 |
| Ax | A+0160 | A+0161 | A+0162 | A+0163 | A+0164 | A+0165 | A+0166 | A+0167 | A+0168 | A+0169 | A+0170 | A+0171 | A+0172 | A+0173 | A+0174 | A+0175 |
| Bx | A+0176 | A+0177 | A+0178 | A+0179 | A+0180 | A+0181 | A+0182 | A+0183 | A+0184 | A+0185 | A+0186 | A+0187 | A+0188 | A+0189 | A+0190 | A+0191 |
| Cx | A+0192 | A+0193 | A+0194 | A+0195 | A+0196 | A+0197 | A+0198 | A+0199 | A+0200 | A+0201 | A+0202 | A+0203 | A+0204 | A+0205 | A+0206 | A+0207 |
| Dx | A+0208 | A+0209 | A+0210 | A+0211 | A+0212 | A+0213 | A+0214 | A+0215 | A+0216 | A+0217 | A+0218 | A+0219 | A+0220 | A+0221 | A+0222 | A+0223 |
| Ex | A+0224 | A+0225 | A+0226 | A+0227 | A+0228 | A+0229 | A+0230 | A+0231 | A+0232 | A+0233 | A+0234 | A+0235 | A+0236 | A+0237 | A+0238 | A+0239 |
| Fx | A+0240 | A+0241 | A+0242 | A+0243 | A+0244 | A+0245 | A+0246 | A+0247 | A+0248 | A+0249 | A+0250 | A+0251 | A+0252 | A+0253 | A+0254 | A+0255 |

Digital Interface

Table F-5. Scancode Set When Control Character is 00 or 01

| | X0 | x1 | x2 | x3 | x4 | x5 | x6 | x7 | x8 | x9 | xA | xB | xC | xD | xE | xF |
|----|---------------|---------------|---------------|---------------|---------------|---------------|---------------|---------------|---------------|--------------|---------------|--------------|--------------|-------------|--------------|--------------|
| 0x | NULL C+@ | SOH C(S)+A | STX C(S)+B | ETX C(S)+C | EOT C+D | ENQ C(S)+E | ACK C(S)+F | BEL C(S)+G | BS | HT TAB | LF C(S)+J | VT C(S)+K | FF C(S)+L | CR Enter | SO C(S)+N | SI C(S)+O |
| 1x | DLE C(S)+P | DC1 C(S)+Q | DC2 C(S)+R | DC3 C(S)+S | DC4 C(S)+T | NAK C(S)+U | SYN C(S)+V | ETB C(S)+W | CAN C(S)+X | EM C(S)+Y | SUB C(S)+Z | ESC Esc | FS C(S)+\ | GS C+] | RS C(S)+^ | US C(S)+_ |
| 2x | Space | ! | " | # | \$ | % | & | ' | (|) | * | + | , | - | . | / |
| 3x | 0 | 1 | 2 | 3 | 4 | 5 | 6 | 7 | 8 | 9 | : | ; | < | = | > | ? |
| 4x | @ | A | B | C | D | E | F | G | H | I | J | K | L | M | N | O |
| 5x | P | Q | R | S | T | U | V | W | X | Y | Z | [| \ |] | ^ | _ |
| 6x | , | a | b | c | d | e | f | g | h | i | j | k | l | m | n | o |
| 7x | p | q | r | s | t | u | v | w | x | y | z | { | | } | ~ | Del |
| 8x | | Sh↓ | Sh↑ | Ins | Ent (keyp) | F1 | F2 | F3 | F4 | F5 | F6 | F7 | F8 | F9 | F10 | F11 |
| 9x | F12 | F13 | F14 | F15 | F16 | ↑ | ↓ | ← | → | | | | | Cl↓ | Cl↑ | |

Digital Interface — cont.

Table F-6. Scancode Set When Control Character is 02

| | X0 | x1 | x2 | x3 | x4 | x5 | x6 | x7 | x8 | x9 | xA | xB | xC | xD | xE | xF |
|----|-------|----|----|----|-----|-----|----|----|----|-----|----|-------|-------------|-------|-----|-----|
| 0x | | | | | Cl↓ | Cl↑ | | | BS | Tab | → | S+Tab | Enter Keypd | Enter | Ins | |
| 1x | | | ← | ↓ | ↑ | F6 | F1 | F2 | F3 | F4 | F5 | ESC | F7 | F8 | F9 | F10 |
| 2x | Space | ! | " | # | \$ | % | & | ' | (|) | * | + | , | - | . | / |
| 3x | 0 | 1 | 2 | 3 | 4 | 5 | 6 | 7 | 8 | 9 | : | ; | < | = | > | ? |
| 4x | @ | A | B | C | D | E | F | G | H | I | J | K | L | M | N | O |
| 5x | P | Q | R | S | T | U | V | W | X | Y | Z | [| \ |] | ^ | _ |
| 6x | ' | a | b | c | d | e | f | g | h | i | j | k | l | m | n | o |
| 7x | p | q | r | s | t | u | v | w | x | y | z | { | | } | ~ | Del |

IBM31xx 102-key

Table F-7. Scancode Set When Control Character is 00 or 01

| | X0 | x1 | x2 | x3 | x4 | x5 | x6 | x7 | x8 | x9 | xA | xB | xC | xD | xE | xF |
|----|---------------|---------------|---------------|---------------|---------------|---------------|---------------|-----------------|---------------|--------------|---------------|--------------|--------------|-------------|--------------|--------------|
| 0x | NULL C+@ | SOH C(S)+A | STX C(S)+B | ETX C(S)+C | EOT C+D | ENQ C(S)+E | ACK C(S)+F | BEL C(S)+G | BS C(S)+H | HT TAB | LF C(S)+J | VT C(S)+K | FF C(S)+L | CR Enter | SO C(S)+N | SI C(S)+O |
| 1x | DLE C(S)+P | DC1 C(S)+Q | DC2 C(S)+R | DC3 C(S)+S | DC4 C(S)+T | NAK C(S)+U | SYN C(S)+V | ETB C(S)+W | CAN C(S)+X | EM C(S)+Y | SUB C(S)+Z | ESC Esc | FS C(S)+\ | GS C+] | RS C(S)+^ | US C(S)+_ |
| 2x | Space | ! | " | # | \$ | % | & | ' | (|) | * | + | , | - | . | / |
| 3x | 0 | 1 | 2 | 3 | 4 | 5 | 6 | 7 | 8 | 9 | : | ; | < | = | > | ? |
| 4x | @ | A | B | C | D | E | F | G | H | I | J | K | L | M | N | O |
| 5x | P | Q | R | S | T | U | V | W | X | Y | Z | [| \ |] ^ | ^ | _ |
| 6x | , | a | B | c | d | e | f | g | h | i | j | k | l | m | n | o |
| 7x | p | q | R | s | t | u | v | w | x | y | z | { | | } | | Del |
| 8x | | Sh↓ | Sh↑ | Ins | Ent (keyp) | F1 | F2 | F3 | F4 | F5 | F6 | F7 | F8 | F9 | F10 | F11 |
| 9x | F12 | Enter | Reset | Insert | Delete | Field - | Field + | Enter paddle | Printl | Ar↓ | Ar↑ | All↓ | Al↑ | Cl↓ | Cl↑ | Cr↓ |
| Ax | Cr↑ | | | | | | | | | | | | | | | |

IBM31xx 102-key – cont.

Table F-8. Scancode Set When Control Character is 02

| | X0 | x1 | x2 | x3 | x4 | x5 | x6 | x7 | x8 | x9 | xA | xB | xC | xD | xE | xF |
|----|--------|------|-----|-----|-----|-----|-----|-----|----|-----|----|--------|-------------|-------|-----|-------|
| 0x | Ar↓ | Ar↑ | Al↓ | Al↑ | Cl↓ | Cl↑ | Cr↓ | Cr↑ | BS | Tab | → | S+ Tab | Enter Keypd | Enter | Ins | Pg Up |
| 1x | Pg Dwn | Home | ← | ↓ | ↑ | F6 | F1 | F2 | F3 | F4 | F5 | ESC | F7 | F8 | F9 | F10 |
| 2x | Space | ! | " | # | \$ | % | & | ' | (|) | * | + | , | - | . | / |
| 3x | 0 | 1 | 2 | 3 | 4 | 5 | 6 | 7 | 8 | 9 | : | ; | < | = | > | ? |
| 4x | @ | A | B | C | D | E | F | G | H | I | J | K | L | M | N | O |
| 5x | P | Q | R | S | T | U | V | W | X | Y | Z | [| \ |] | ^ | _ |
| 6x | , | a | B | c | d | e | f | g | h | i | j | k | l | m | n | o |
| 7x | p | q | R | s | t | u | v | w | x | y | z | { | | } | | Del |

IBM XT

Table F-9. Scancode Set When Control Character is 00 or 01

| | X0 | x1 | x2 | x3 | x4 | x5 | x6 | x7 | x8 | x9 | xA | xB | xC | xD | xE | xF |
|----|---------------|---------------|---------------|---------------|---------------|---------------|---------------|---------------|---------------|--------------|---------------|--------------|--------------|-------------|--------------|--------------|
| 0x | NULL C+@ | SOH C(S)+A | STX C(S)+B | ETX C(S)+C | EOT C+D | ENQ C(S)+E | ACK C(S)+F | BEL C(S)+G | BS C(S)+H | HT TAB | LF C(S)+J | VT C(S)+K | FF C(S)+L | CR Enter | SO C(S)+N | SI C(S)+O |
| 1x | DLE C(S)+P | DC1 C(S)+Q | DC2 C(S)+R | DC3 C(S)+S | DC4 C(S)+T | NAK C(S)+U | SYN C(S)+V | ETB C(S)+W | CAN C(S)+X | EM C(S)+Y | SUB C(S)+Z | ESC Esc | FS C(S)+\ | GS C+] | RS C(S)+^ | US C(S)+_ |
| 2x | Space | ! | " | # | \$ | % | & | ' | (|) | * | + | , | - | . | / |
| 3x | 0 | 1 | 2 | 3 | 4 | 5 | 6 | 7 | 8 | 9 | : | ; | < | = | > | ? |
| 4x | @ | A | B | C | D | E | F | G | H | I | J | K | L | M | N | O |
| 5x | P | Q | R | S | T | U | V | W | X | Y | Z | [| \ |] | ^ | _ |
| 6x | , | a | B | c | d | e | f | g | h | i | j | k | l | m | n | o |
| 7x | p | q | R | s | t | u | v | w | x | y | z | { | | } | | Del |
| 8x | | Sh↓ | Sh↑ | Ins | Ent (keyp) | F1 | F2 | F3 | F4 | F5 | F6 | F7 | F8 | F9 | F10 | F11 |
| 9x | F12 | Home | End | Pg Up | Pg Dwn | ↑ | ↓ | ← | → | Ar↓ | Ar↑ | All↓ | All↑ | Cl↓ | Cl↑ | Cr↓ |
| Ax | Cr↑ | | | | | | | | | | | | | | | |

IBM XT — cont.

Table F-10. Scancode Set When Control Character is 02

| | X0 | x1 | x2 | x3 | x4 | x5 | x6 | x7 | x8 | x9 | xA | xB | xC | xD | xE | xF |
|----|--------|------|-----|-----|-----|-----|-----|-----|----|-----|----|--------|-------------|-------|-----|-------|
| 0x | Ar↓ | Ar↑ | Al↓ | Al↑ | Cl↓ | Cl↑ | Cr↓ | Cr↑ | BS | Tab | → | S+ Tab | Enter Keypd | Enter | Ins | Pg Up |
| 1x | Pg Dwn | Home | ← | ↓ | ↑ | F6 | F1 | F2 | F3 | F4 | F5 | ESC | F7 | F8 | F9 | F10 |
| 2x | Space | ! | “ | # | \$ | % | & | ‘ | (|) | * | + | , | - | . | / |
| 3x | 0 | 1 | 2 | 3 | 4 | 5 | 6 | 7 | 8 | 9 | : | ; | < | = | > | ? |
| 4x | @ | A | B | C | D | E | F | G | H | I | J | K | L | M | N | O |
| 5x | P | Q | R | S | T | U | V | W | X | Y | Z | [| \ |] | ^ | _ |
| 6x | , | a | B | c | d | e | f | g | h | i | j | k | l | m | n | o |
| 7x | p | q | R | s | t | u | v | w | x | y | z | { | | } | | Del |

Microsoft Windows Codepage 1252

Windows-1252 is a character encoding of the Latin alphabet, used by default in the legacy components of Microsoft Windows in English and some other Western languages.

| | 00 | 01 | 02 | 03 | 04 | 05 | 06 | 07 | 08 | 09 | 0A | 0B | 0C | 0D | 0E | 0F |
|----|---------------------|--------------------|--------------------|--------------------|--------------------|--------------------|--------------------|--------------------|--------------------|-------------------|--------------------|--------------------|-------------------|-------------------|-------------------|--------------------|
| 00 | <u>NUL</u> 0000 | <u>STX</u> 0001 | <u>SOT</u> 0002 | <u>ETX</u> 0003 | <u>EOT</u> 0004 | <u>ENQ</u> 0005 | <u>ACK</u> 0006 | <u>BEL</u> 0007 | <u>BS</u> 0008 | <u>HT</u> 0009 | <u>LF</u> 000A | <u>VT</u> 000B | <u>FF</u> 000C | <u>CR</u> 000D | <u>SO</u> 000E | <u>SI</u> 000F |
| 10 | <u>DLE</u> 0010 | <u>DC1</u> 0011 | <u>DC2</u> 0012 | <u>DC3</u> 0013 | <u>DC4</u> 0014 | <u>NAK</u> 0015 | <u>SYN</u> 0016 | <u>ETB</u> 0017 | <u>CAN</u> 0018 | <u>EM</u> 0019 | <u>SUB</u> 001A | <u>ESC</u> 001B | <u>FS</u> 001C | <u>GS</u> 001D | <u>RS</u> 001E | <u>US</u> 001F |
| 20 | <u>SP</u> 0020 | ! | " | # | \$ | % | & | ' | (|) | * | + | , | - | . | / |
| 30 | 0 | 1 | 2 | 3 | 4 | 5 | 6 | 7 | 8 | 9 | : | ; | < | = | > | ? |
| 40 | @ | A | B | C | D | E | F | G | H | I | J | K | L | M | N | O |
| 50 | P | Q | R | S | T | U | V | W | X | Y | Z | [| \ |] | ^ | _ |
| 60 | ` | a | b | c | d | e | f | g | h | i | j | k | l | m | n | o |
| 70 | p | q | r | s | t | u | v | w | x | y | z | { | | } | ~ | <u>DEL</u> 007F |
| 80 | € 20AC | ⋮ 2018 | ƒ 201A | Œ 201E | … 2026 | † 2020 | ‡ 2021 | ˜ 02C6 | ‰ 2030 | Š 0160 | < 2039 | € 0152 | ⋮ 017D | Ž 017E | ⋮ 0178 | ⋮ 0178 |
| 90 | ⋮ 2018 | ˘ 2019 | ˆ 201C | ˆ 201D | • 2022 | – 2013 | – 2014 | ˜ 02DC | ™ 2122 | Š 0161 | > 203A | œ 0153 | ⋮ 017E | Ž 017E | ÿ 0178 | ÿ 0178 |
| A0 | <u>NBSP</u> 00A0 | ¡ 00A1 | ¢ 00A2 | £ 00A3 | ¤ 00A4 | ¥ 00A5 | ¦ 00A6 | § 00A7 | ¨ 00A8 | © 00A9 | ª 00AA | « 00AB | ¬ 00AC | ­ 00AD | ® 00AE | ¯ 00AF |
| B0 | ° 00B0 | ± 00B1 | ² 00B2 | ³ 00B3 | ´ 00B4 | µ 00B5 | ¶ 00B6 | · 00B7 | ¸ 00B8 | ¹ 00B9 | º 00BA | » 00BB | ¼ 00BC | ½ 00BD | ¾ 00BE | ¿ 00BF |
| C0 | À 00C0 | Á 00C1 | Â 00C2 | Ã 00C3 | Ä 00C4 | Å 00C5 | Æ 00C6 | Ç 00C7 | È 00C8 | É 00C9 | Ê 00CA | Ë 00CB | Ì 00CC | Í 00CD | Î 00CE | Ï 00CF |
| D0 | Ð 00D0 | Ñ 00D1 | Ò 00D2 | Ó 00D3 | Ô 00D4 | Õ 00D5 | Ö 00D6 | × 00D7 | Ø 00D8 | Ù 00D9 | Ú 00DA | Û 00DB | Ü 00DC | Ý 00DD | Þ 00DE | ß 00DF |
| E0 | à 00E0 | á 00E1 | â 00E2 | ã 00E3 | ä 00E4 | å 00E5 | æ 00E6 | ç 00E7 | è 00E8 | é 00E9 | ê 00EA | ë 00EB | ì 00EC | í 00ED | î 00EE | ï 00EF |
| F0 | ð 00F0 | ñ 00F1 | ò 00F2 | ó 00F3 | ô 00F4 | õ 00F5 | ö 00F6 | ÷ 00F7 | ø 00F8 | ù 00F9 | ú 00FA | û 00FB | ü 00FC | ý 00FD | þ 00FE | ÿ 00FF |

A

Ambient Light Immunity 368

B

bar codes

RS-232

baud rate 85

RS-232 parameters

parity 331, 333, 336, 338

barcodes

cancel 395

numeric barcodes 395

RS-232 parameters

parity 76

Beeper

Pitch, Good Read 27, 28

Volume, Good Read 30

Beeper Volume 368

Beeper, Good Read 25

C

Cable Pinouts 370

Clear to Send 52

Code 39 Format 95

Conversion, case 123

Conversion, character 124

Convert to Code 128 100

Convert to Code 39 100

CTS 52

D

Decode Capability 368

Defaults 371

Depth of Field 368

Dimensions 367

Drop Specifications 368

E

Leading/trailing noise 101

Electrical Safety 369

EMI/RFI 369

Error Codes 389

Errors 389

G

Good Read, Beeper 25

Pitch 27, 28

Volume 30

Good Read, Beeper – 25

Good Read, Beeper Pitch – 27, 28

Good Read, Beeper Volume – 30

Green Spot 385

H

Handheld Scanner 88, 89, 96

Host Resets 92

Humidity 368

I

IBM interface selection 14

IBM Standard Format 95

Idle State (wand) 97

Indications 385

Interface Type 10

Interfaces Supported 368

K

keyboard support 74

KEYBOARD WEDGE (KBW) interface
selection 15

L

Light Source 367

M

Mixed OEM Standard + Code 39 Format 95

N

numbers lock key 77

O

Operating Temperature 368

P

Performance Characteristics 367
Physical Characteristics 367
Pitch – Good Read, Beeper 27, 28
Pitch Tolerance 368
Polarity (wand) 98
Prefix/Suffix 104
Print Contrast Minimum 368
Product Specifications 367
Programming Barcodes 9

R

Read, Beeper – Good 25
Read, Beeper Pitch – Good 27, 28
Read, Beeper Volume – Good 30
Request to Send 52
Roll (Tilt) Tolerance 368
RS-232 interface selection 14
RTS 52

S

sample bar codes
 code 128 391
 code 39 391
 interleaved 2 of 5 392
select digits/characters 395

Serial Output 370
Signal Speed (wand) 99
Skew (Yaw) Tolerance 368
Standard Cable Pinouts 370
Storage Temperature 368
Suffix 104
Symbology Conversion 100
symbology types 391

T

Table Top Scanner 88, 89, 96
trailing noise 101

U

UPC 130
USB interface selection 14
User Environment 368, 369

V

Volume – Good Read, Beeper 30

W

Weight 367

X

XON/XOFF 52

ASCII Character Set

The table on this page shows a set of ASCII characters and their corresponding Hex Values. The Hex Values in this table are needed for setting symbology specific label identifiers, as well as enabling custom prefix and suffix characters.

| ASCII Char. | Hex No. | ASCII Char. | Hex No. | ASCII Char. | Hex No. | ASCII Char. | Hex No. |
|-------------|---------|-------------|---------|-------------|---------|-------------|---------|
| NUL | 00 | SP | 20 | @ | 40 | ' | 60 |
| SOH | 01 | ! | 21 | A | 41 | a | 61 |
| STX | 02 | " | 22 | B | 42 | b | 62 |
| ETX | 03 | # | 23 | C | 43 | c | 63 |
| EOT | 04 | \$ | 24 | D | 44 | d | 64 |
| ENQ | 05 | % | 25 | E | 45 | e | 65 |
| ACK | 06 | & | 26 | F | 46 | f | 66 |
| BEL | 07 | ' | 27 | G | 47 | g | 67 |
| BS | 08 | (| 28 | H | 48 | h | 68 |
| HT | 09 |) | 29 | I | 49 | i | 69 |
| LF | 0A | * | 2A | J | 4A | j | 6A |
| VT | 0B | + | 2B | K | 4B | k | 6B |
| FF | 0C | , | 2C | L | 4C | l | 6C |
| CR | 0D | - | 2D | M | 4D | m | 6D |
| SO | 0E | . | 2E | N | 4E | n | 6E |
| SI | 0F | / | 2F | O | 4F | o | 6F |
| DLE | 10 | 0 | 30 | P | 50 | p | 70 |
| DC1 | 11 | 1 | 31 | Q | 51 | q | 71 |
| DC2 | 12 | 2 | 32 | R | 52 | r | 72 |
| DC3 | 13 | 3 | 33 | S | 53 | s | 73 |
| DC4 | 14 | 4 | 34 | T | 54 | t | 74 |
| NAK | 15 | 5 | 35 | U | 55 | u | 75 |
| SYN | 16 | 6 | 36 | V | 56 | v | 76 |
| ETB | 17 | 7 | 37 | W | 57 | w | 77 |
| CAN | 18 | 8 | 38 | X | 58 | x | 78 |
| EM | 19 | 9 | 39 | Y | 59 | y | 79 |
| SUB | 1A | : | 3A | Z | 5A | z | 7A |
| ESC | 1B | ; | 3B | [| 5B | { | 7B |
| FS | 1C | < | 3C | \ | 5C | | 7C |
| GS | 1D | = | 3D |] | 5D | } | 7D |
| RS | 1E | > | 3E | ^ | 5E | ~ | 7E |
| US | 1F | ? | 3F | _ | 5F | DEL | 7F |



www.datalogic.com

© 2008-2014 Datalogic ADC, Inc. • All rights reserved. •
Datalogic and the Datalogic logo are registered trademarks of
Datalogic S.p.A. in many countries, including the U.S.A. and the E.U.

Datalogic ADC, Inc.

959 Terry Street | Eugene | OR 97402 | USA
Telephone: (1) 541-683-5700 | Fax: (1) 541-345-7140

